



EVALUATION REPORT

FLORIDA BUILDING CODE 6TH EDITION (2017)

Manufacturer: ATLAS ROOFING CORPORATION
 2000 Riveredge Parkway, Suite 800
 Atlanta, GA 30328
 (770) 612-6267

Issued August 26, 2019

Manufacturing Plants: Hampton, GA
 Meridian, MS
 Dangerfield, TX
 Ardmore, OK
 Franklin, OH

Quality Assurance: PRI Construction Materials Technologies, LLC
 (QUA9110)

SCOPE

Category: Roofing
Subcategory: Asphalt Shingles
Code Sections: 1504.1.1, 1507.2.5, 1507.2.7.1, 1523.6.5.1
Properties: Physical properties, Wind Resistance, Wind Driven Rain

PRODUCT DESCRIPTION

Legend (Ardmore)	ASTM D 3161, Class F fiberglass reinforced, 3-tab asphalt shingle with a dashed, thermally-activated, self-sealing sealant stripe that complies with ASTM D 3462.
GlassMaster® 30 (Ardmore & Hampton)	ASTM D 3161, Class F fiberglass reinforced, 3-tab asphalt shingle with a dashed, thermally-activated, self-sealing sealant stripe that complies with ASTM D 3462.
Tough-Master® 20 (Ardmore & Hampton)	ASTM D 3161, Class F fiberglass reinforced, 3-tab asphalt shingle with a dashed, thermally-activated, self-sealing sealant stripe that complies with ASTM D 3462.
Pro-Cut® Hip & Ridge (Ardmore & Hampton)	ASTM D 3161, Class F fiberglass reinforced, hip and ridge asphalt shingle with a dashed, thermally-activated, self-sealing sealant stripe that complies with ASTM D 3462.
Pro-Cut® Starter Strip (Hampton)	ASTM D 3161, Class F fiberglass reinforced, starter asphalt shingle with a dashed, thermally-activated, self-sealing sealant stripe that complies with ASTM D 3462.
ProLAM™ Architectural (Hampton, Franklin & Meridian)	ASTM D 3161, Class F & ASTM D 7158, Class H fiberglass reinforced, laminated architectural asphalt shingle with a dashed, thermally-activated, self-sealing sealant stripe that complies with ASTM D 3462.
Pinnacle® Pristine, Pinnacle® Pristine Lifetime w/Scotchgard (Dangerfield, Hampton, Franklin & Meridian)	ASTM D 3161, Class F & ASTM D 7158, Class H fiberglass reinforced, laminated architectural asphalt shingle with two, dashed, thermally-activated, self-sealing sealant stripes that complies with ASTM D 3462.
StormMaster® Shake (Dangerfield)	ASTM D 3161, Class F & ASTM D 7158, Class H fiberglass reinforced, laminated architectural modified asphalt shingle with two, dashed, thermally-activated, self-sealing sealant stripe that complies with ASTM D 3462.

**StormMaster® Slate
(Ardmore)**

ASTM D 3161, Class F & ASTM D 7158, Class H fiberglass reinforced, laminated architectural modified asphalt shingle with two, dashed, thermally-activated, self-sealing sealant stripe that complies with ASTM D 3462.

REFERENCES

<u>Entity</u>	<u>Report No.</u>	<u>Standard</u>	<u>Year</u>
PRI Construction Materials Technologies (TST5878)	ATL-079-02-01	ASTM D 3161	2016
		TAS 107	1995
PRI Construction Materials Technologies (TST5878)	ATL-083-02-01	TAS 100	1995
PRI Construction Materials Technologies (TST5878)	ATL-086-02-01 Rev 1	ASTM D 3462	2010A
PRI Construction Materials Technologies (TST5878)	ATL-104-02-01	ASTM D 3462	2010A
PRI Construction Materials Technologies (TST5878)	ATL-106-02-01	ASTM D 3161	2016
		TAS 107	1995
PRI Construction Materials Technologies (TST5878)	ATL-106-02-01 Rev 1	ASTM D 3161	2016
		TAS 107	1995
PRI Construction Materials Technologies (TST5878)	ATL-107-02-01	TAS 100	1995
PRI Construction Materials Technologies (TST5878)	ATL-107-02-01.1	TAS 100	1995
PRI Construction Materials Technologies (TST5878)	ATL-109-02-01	ASTM D 7158	2011
PRI Construction Materials Technologies (TST5878)	ATL-116-02-01	ASTM D 3462	2010A
PRI Construction Materials Technologies (TST5878)	ATL-118-02-01	ASTM D 3462	2010A
PRI Construction Materials Technologies (TST5878)	ATL-119-02-01	TAS 100	1995
PRI Construction Materials Technologies (TST5878)	ATL-123-02-01	ASTM D 7158	2011
PRI Construction Materials Technologies (TST5878)	ATL-125-02-01	TAS 100	1995
PRI Construction Materials Technologies (TST5878)	ATL-127-02-01 Rev 1	ASTM D 7158	2011
PRI Construction Materials Technologies (TST5878)	ATL-132-02-01	ASTM D 3161	2016
		TAS 107	1995
PRI Construction Materials Technologies (TST5878)	ATL-133-02-01	ASTM D 3161	2016
		TAS 107	1995
PRI Construction Materials Technologies (TST5878)	ATL-135-02-01	ASTM D 3462	2010A
PRI Construction Materials Technologies (TST5878)	ATL-136-02-01	ASTM D 3462	2010A
PRI Construction Materials Technologies (TST5878)	ATL-137-02-01 Rev 1	ASTM D 7158	2011
PRI Construction Materials Technologies (TST5878)	ATL-138-02-01 Rev 1	ASTM D 7158	2011
PRI Construction Materials Technologies (TST5878)	ATL-143-02-01	ASTM D 3161	2016
		TAS 107	1995
PRI Construction Materials Technologies (TST5878)	ATL-144-02-01	ASTM D 3161	2016
		TAS 107	1995
PRI Construction Materials Technologies (TST5878)	ATL-151-02-01	ASTM D 3462	2010A
PRI Construction Materials Technologies (TST5878)	ATL-162-02-01	TAS 100	1995
PRI Construction Materials Technologies (TST5878)	ATL-167-02-01	ASTM D 3161	2016
PRI Construction Materials Technologies (TST5878)	ATL-168-02-01	ASTM D 3161	2016
		TAS 107	1995
PRI Construction Materials Technologies (TST5878)	ATL-169-02-01	ASTM D 3462	2010A
PRI Construction Materials Technologies (TST5878)	ATL-170-02-01	ASTM D 3462	2010A
PRI Construction Materials Technologies (TST5878)	ATL-171-02-01	ASTM D 3462	2010A
PRI Construction Materials Technologies (TST5878)	ATL-172-02-01	ASTM D 3462	2010A
PRI Construction Materials Technologies (TST5878)	ATL-174-02-01	ASTM D 3462	2010A
PRI Construction Materials Technologies (TST5878)	ATL-179-02-01	TAS 100	1995
PRI Construction Materials Technologies (TST5878)	ATL-184-02-01	ASTM D 3161	2016
		TAS 107	1995
PRI Construction Materials Technologies (TST5878)	ATL-185-02-01	ASTM D 7158	2011
PRI Construction Materials Technologies (TST5878)	ATL-186-02-01	TAS 100	1995
PRI Construction Materials Technologies (TST5878)	ATL-187-02-01	ASTM D 3462	2010A
PRI Construction Materials Technologies (TST5878)	ATL-220-02-01	ASTM D 3462	2010A
PRI Construction Materials Technologies (TST5878)	ATL-220-02-02	TAS 100	1995
PRI Construction Materials Technologies (TST5878)	ATL-220-02-03	ASTM D 3161	2016
		TAS 107	1995
PRI Construction Materials Technologies (TST5878)	ATL-220-02-04	ASTM D 7158	2011
PRI Construction Materials Technologies (TST5878)	ATL-221-02-01	ASTM D 3462	2010A
PRI Construction Materials Technologies (TST5878)	ATL-221-02-02	TAS 100	1995
PRI Construction Materials Technologies (TST5878)	ATL-221-02-03	ASTM D 3161	2016
		TAS 107	1995
PRI Construction Materials Technologies (TST5878)	ATL-221-02-04	ASTM D 7158	2011
PRI Construction Materials Technologies (TST5878)	ATL-222-02-01	ASTM D 3462	2010A
PRI Construction Materials Technologies (TST5878)	ATL-222-02-02	TAS 100	1995



<u>Entity</u>	<u>Report No.</u>	<u>Standard</u>	<u>Year</u>
PRI Construction Materials Technologies (TST5878)	ATL-222-02-03	ASTM D 3161 TAS 107	2016 1995
PRI Construction Materials Technologies (TST5878)	ATL-222-02-04	ASTM D 7158	2011
PRI Construction Materials Technologies (TST5878)	ATL-223-02-01	ASTM D 3462	2010A
PRI Construction Materials Technologies (TST5878)	ATL-223-02-02	TAS 100	1995
PRI Construction Materials Technologies (TST5878)	ATL-223-02-03	ASTM D 3161 TAS 107	2016 1995
PRI Construction Materials Technologies (TST5878)	ATL-223-02-04	ASTM D 7158	2011
PRI Construction Materials Technologies (TST5878)	ATL-224-02-01	ASTM D 3462	2010A
PRI Construction Materials Technologies (TST5878)	ATL-225-02-01	ASTM D 3462	2010A
PRI Construction Materials Technologies (TST5878)	ATL-225-02-02	TAS 100	1995
PRI Construction Materials Technologies (TST5878)	ATL-225-02-03	ASTM D 3161 TAS 107	2016 1995
PRI Construction Materials Technologies (TST5878)	ATL-225-02-04	ASTM D 7158	2011
CREEK Technical Services LLC (ANE11669)	ATL13002.7	Calculations	2018

INSTALLATION

Legend	Basic Wind Speed (V_{ult}):	Max. 194 mph
	Basic Wind Speed (V_{asd}):	Max. 150 mph
	Deck (HVHZ):	In accordance with FBC requirements; Solidly sheathed min. 19/32 in. plywood or wood plank for new construction; Min. 15/32 in. plywood existing construction.
	Deck (Non-HVHZ):	Solidly sheathed in accordance with FBC requirements.
	Underlayment:	In accordance with FBC requirements.
	Min. slope:	2:12 and in accordance with FBC requirements. Contact the Atlas Roofing Corporation when installing at slope greater than 21:12.
	Installation (HVHZ):	Installed with 5-inch exposure in accordance with RAS 115 and manufacturer's published installation instructions. Shingles shall be attached using "6 Nail Pattern" detailed below.
	Installation (Non-HVHZ):	Installed with 5-inch exposure in accordance with FBC requirements and manufacturer's published installation instructions. Shingles shall be attached using either "4 Nail Pattern" or "6 Nail Pattern" detailed below.

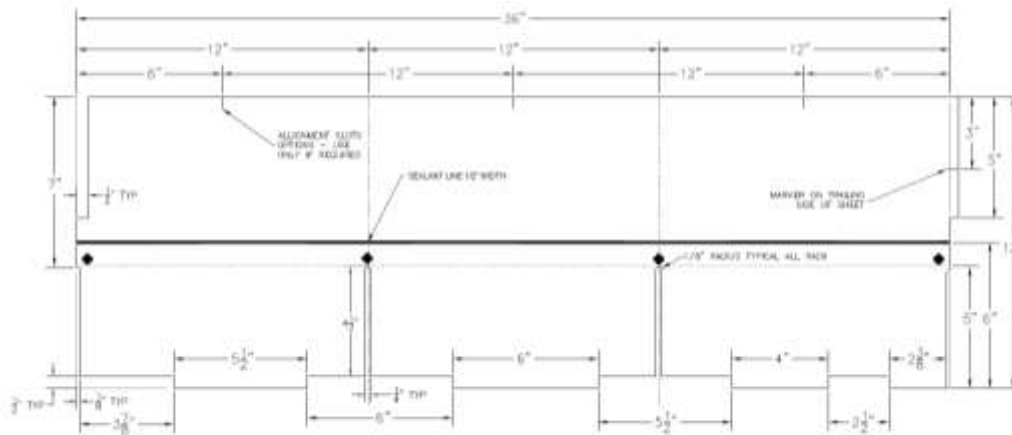

Figure 1. Legend 4 Nail Pattern (Non-HVHZ only)

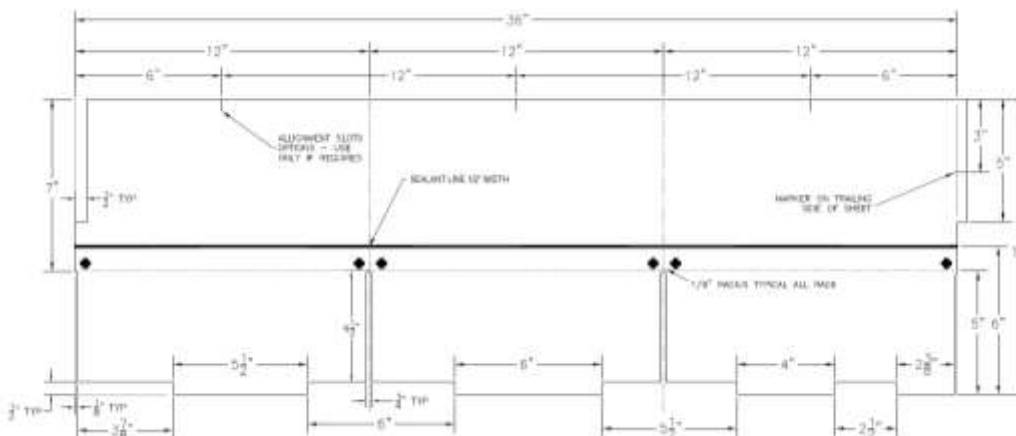

Figure 2. Legend 6 Nail Pattern

GlassMaster® 30 & Tough-Master® 20

Basic Wind Speed (V_{ult}):	Max. 194 mph
Basic Wind Speed (V_{asd}):	Max. 150 mph
Deck (HVHZ):	In accordance with FBC requirements; Solidly sheathed min. 19/32 in. plywood or wood plank for new construction; Min. 15/32 in. plywood existing construction.
Deck (Non-HVHZ):	Solidly sheathed in accordance with FBC requirements.
Underlayment:	In accordance with FBC requirements.
Min. slope:	2:12 and in accordance with FBC requirements. Contact the Atlas Roofing Corporation when installing at slope greater than 21:12.
Installation (HVHZ):	Installed with 5-inch exposure in accordance with RAS 115 and manufacturer's published installation instructions. Shingles shall be attached using "6 Nail Pattern" detailed below.
Installation (Non-HVHZ):	Installed with 5-inch exposure in accordance with FBC requirements and manufacturer's published installation instructions. Shingles shall be attached using either "4 Nail Pattern" or "6 Nail Pattern" detailed below.

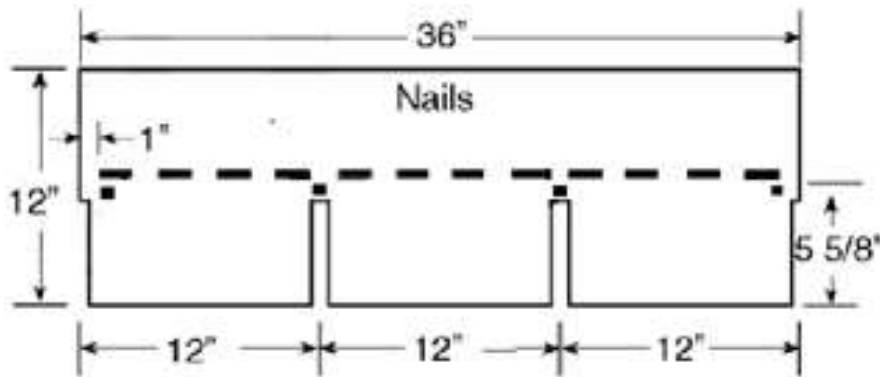

Figure 3. GlassMaster® 30 & Tough-Master® 20 4 Nail Pattern (Non-HVHZ only)

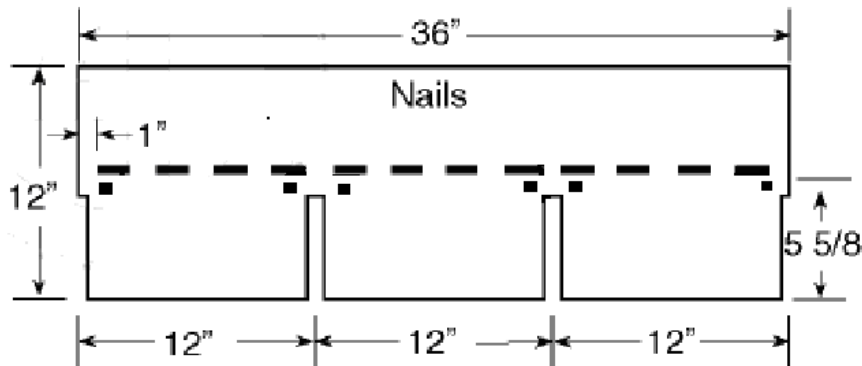

Figure 4. GlassMaster® 30 & Tough-Master® 20 6 Nail Pattern

ProLAM™ Architectural	Basic Wind Speed (V_{ult}):	Max. 194 mph
	Basic Wind Speed (V_{asd}):	Max. 150 mph
	Deck (HVHZ):	In accordance with FBC requirements; Solidly sheathed min. 19/32 in. plywood or wood plank for new construction; Min. 15/32 in. plywood existing construction.
	Deck (Non-HVHZ):	Solidly sheathed in accordance with FBC requirements.
	Underlayment:	In accordance with FBC requirements.
	Min. slope:	2:12 and in accordance with FBC requirements. Contact the Atlas Roofing Corporation when installing at slope greater than 21:12.
	Installation (HVHZ):	Installed with 6 in. exposure in accordance with RAS 115 and manufacturer's published installation instructions. Shingles shall be attached using "6 Nail Pattern" detailed below.
	Installation (Non-HVHZ):	Installed with 6 in. exposure in accordance with FBC requirements and manufacturer's published installation instructions. Shingles shall be attached using either "4 Nail Pattern" or "6 Nail Pattern" detailed below.

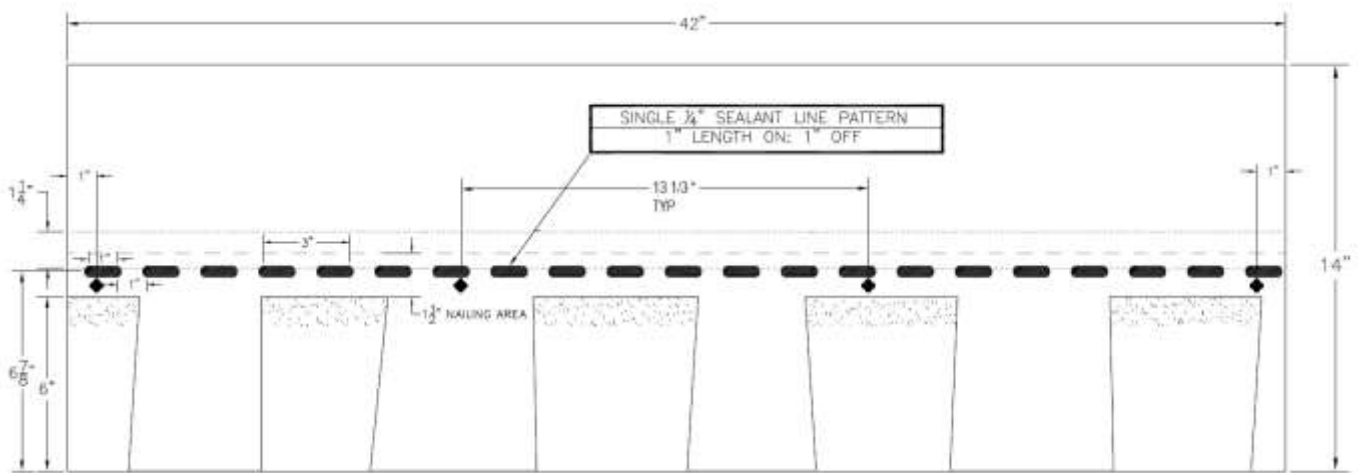

Figure 5. ProLAM™ Architectural Shingle 4 Nail Pattern (non-HVHZ only)

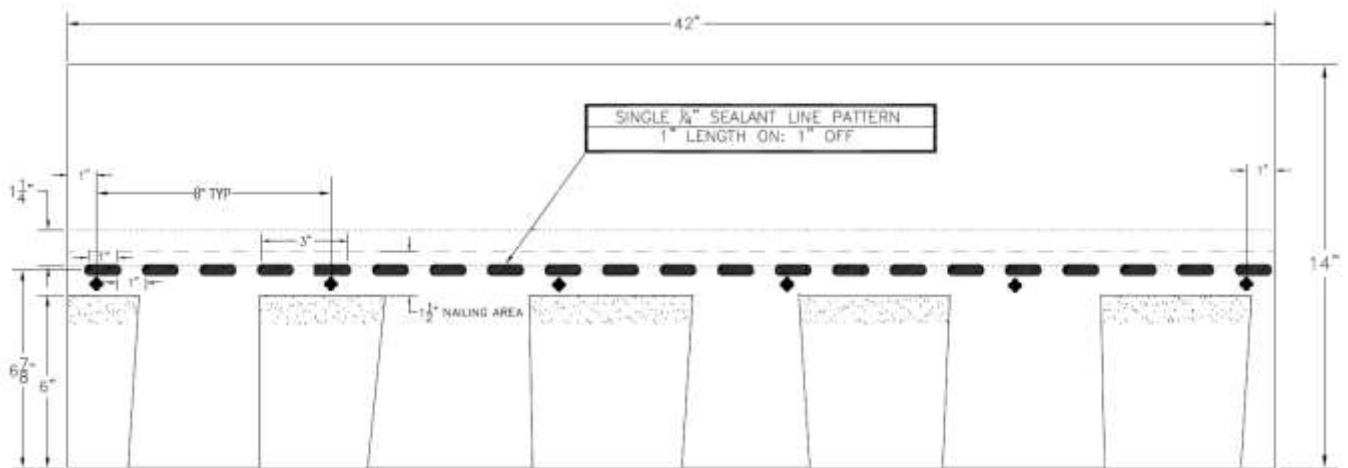

Figure 6. ProLAM™ Architectural Shingle 6 Nail Pattern

Pinnacle® Pristine & StormMaster® Shake

Basic Wind Speed (V_{ult}):	Max. 194 mph
Basic Wind Speed (V_{asd}):	Max. 150 mph
Deck (HVHZ):	In accordance with FBC requirements; Solidly sheathed min. 19/32 in. plywood or wood plank for new construction; Min. 15/32 in. plywood existing construction.
Deck (Non-HVHZ):	Solidly sheathed in accordance with FBC requirements.
Underlayment:	In accordance with FBC requirements.
Min. slope:	2:12 and in accordance with FBC requirements. Contact the Atlas Roofing Corporation when installing at slope greater than 21:12.
Installation (HVHZ):	Installed with 6 in. exposure in accordance with RAS 115 and manufacturer's published installation instructions. Shingles shall be attached using "6 Nail Pattern" detailed below.
Installation (Non-HVHZ):	Installed with 6 in. exposure in accordance with FBC requirements and manufacturer's published installation instructions. Shingles shall be attached using either "4 Nail Pattern" or "6 Nail Pattern" detailed below.

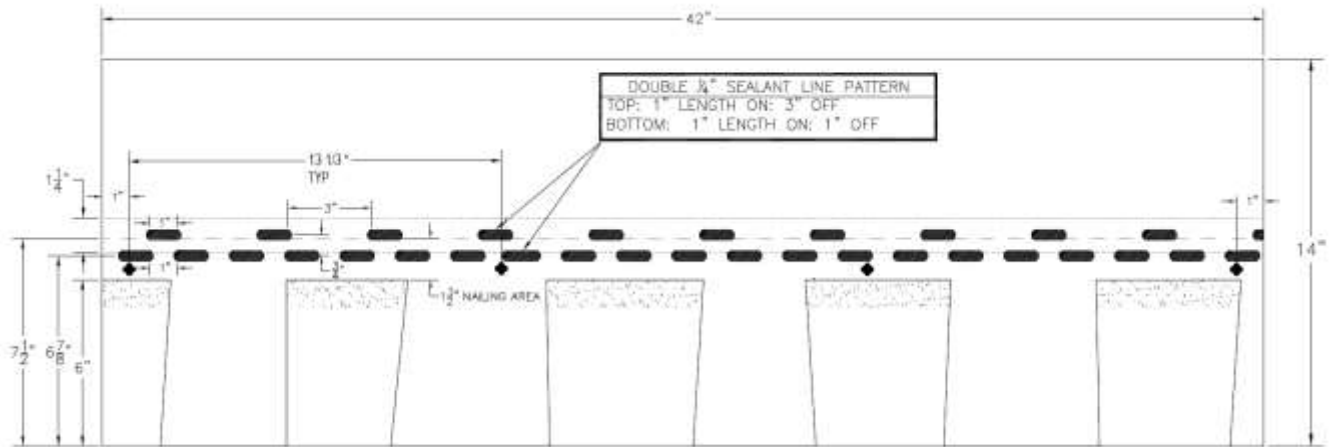

Figure 7. Pinnacle® Pristine and StormMaster® Shake 4 Nail Pattern (Non-HVHZ only)

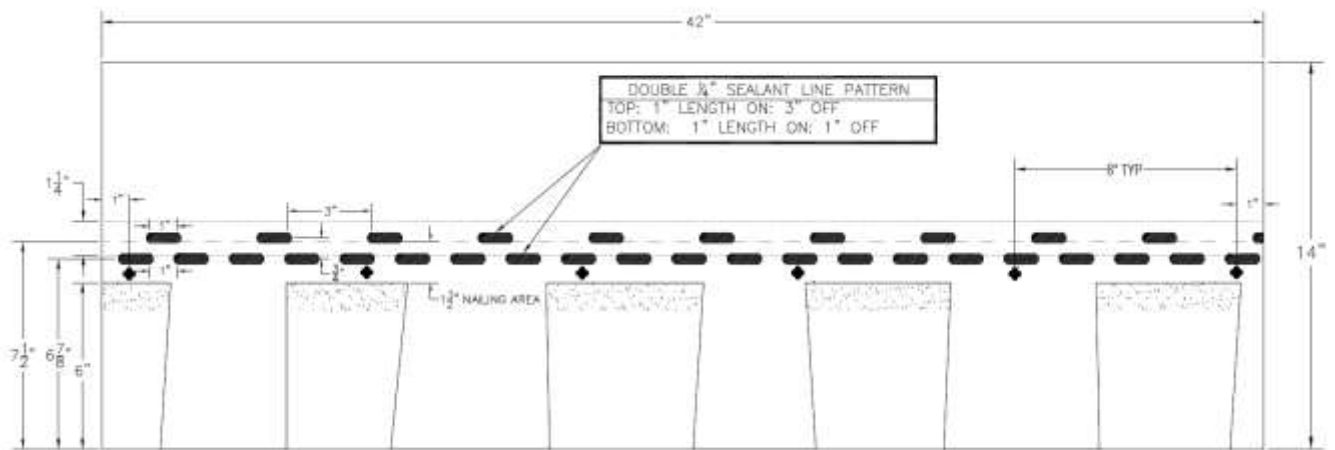

Figure 8. Pinnacle® Pristine and StormMaster® Shake 6 Nail Pattern

StormMaster® Slate

Basic Wind Speed (V_{ult}):	Max. 194 mph
Basic Wind Speed (V_{asd}):	Max. 150 mph
Deck (HVHZ):	In accordance with FBC requirements; Solidly sheathed min. 19/32 in. plywood or wood plank for new construction; Min. 15/32 in. plywood existing construction.
Deck (Non-HVHZ):	Solidly sheathed in accordance with FBC requirements.
Underlayment:	In accordance with FBC requirements.
Min. slope:	2:12 and in accordance with FBC requirements. Contact the Atlas Roofing Corporation when installing at slope greater than 21:12.
Installation (HVHZ):	Installed with 8.5 in. exposure in accordance with RAS 115 and manufacturer's published installation instructions. Shingles shall be attached using "6 Nail Pattern" detailed below.
Installation (Non-HVHZ):	Installed with 8.5 in. exposure in accordance with FBC requirements and manufacturer's published installation instructions. Shingles shall be attached using either "4 Nail Pattern" or "6 Nail Pattern" detailed below.

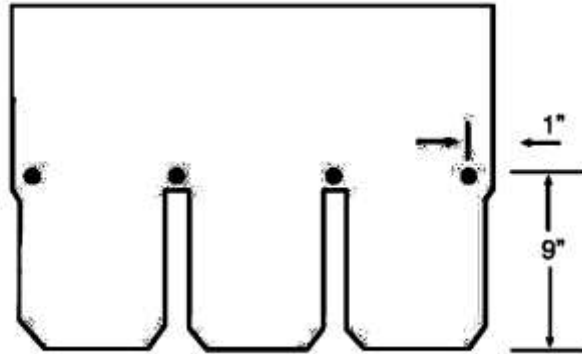

Figure 9. StormMaster® Slate 4 Nail Pattern

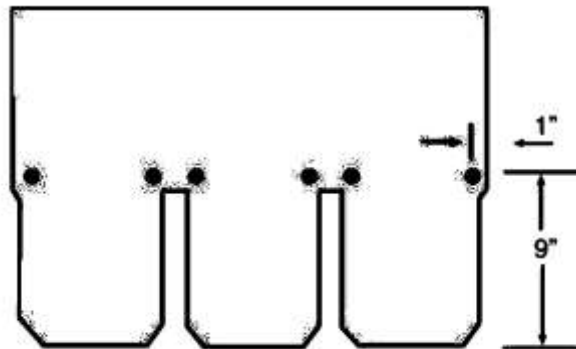

Figure 10. StormMaster® Slate 6 Nail Pattern

Pro-Cut® Starter Strip	Basic Wind Speed (V_{ult}):	Max. 194 mph
	Basic Wind Speed (V_{asd}):	Max. 150 mph
	Deck (HVHZ):	In accordance with FBC requirements; Solidly sheathed min. 19/32 in. plywood or wood plank for new construction; Min. 15/32 in. plywood existing construction.
	Deck (Non-HVHZ):	Solidly sheathed in accordance with FBC requirements.
	Underlayment:	In accordance with FBC requirements.
Min. slope:	2:12 and in accordance with FBC requirements. Contact the Atlas Roofing Corporation when installing at slope greater than 21:12.	
Installation (HVHZ):	Installed in accordance with RAS 115 and manufacturer's published installation instructions. Shingles shall be attached as shown below.	
Installation (Non-HVHZ):	Installed in accordance with FBC requirements and manufacturer's published installation instructions. Shingles shall be attached as shown below.	



Figure 11. Pro-Cut® Starter Strip

Pro-Cut® Hip & Ridge

Basic Wind Speed (V_{ult}):	Max. 194 mph
Basic Wind Speed (V_{asd}):	Max. 150 mph
Deck (HVHZ):	In accordance with FBC requirements; Solidly sheathed min. 19/32 in. plywood or wood plank for new construction; Min. 15/32 in. plywood existing construction.
Deck (Non-HVHZ):	Solidly sheathed in accordance with FBC requirements.
Underlayment:	In accordance with FBC requirements.
Min. slope:	2:12 and in accordance with FBC requirements.
Installation (HVHZ and non-HVHZ):	Installed with 5-5/8 inch exposure in accordance with RAS 115 (HVHZ only) and manufacturer's published installation instructions. The direction of the exposed end shall be away from the prevailing wind.

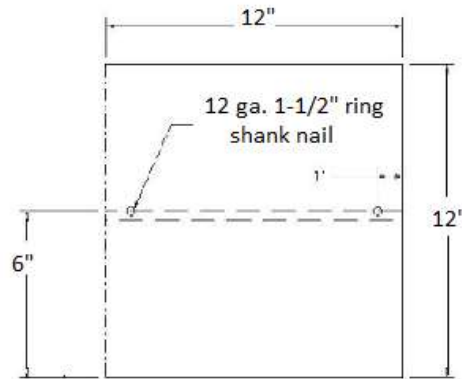

Figure 12. Pro-Cut® Hip & Ridge



LIMITATIONS

- 1) Fire Classification is not within the scope of this evaluation.
- 2) The roof deck and the roof deck attachment shall be designed by others to meet the minimum design loads established for components and cladding and in accordance with FBC requirements.
- 3) The mean roof height shall be restricted to a maximum 33 ft in the HVHZ.
- 4) Classification to ASTM D 7158 applies to exposure B & C with a building mean roof height of 60-ft or less.
- 5) Deck substrates shall be clean, dry, and free from any irregularities and debris. All fasteners in the deck shall be checked for protrusion and corrected prior to underlayment application.
- 6) Shingles shall be installed starting at the eave in horizontal layers such that the laps shed water from the deck.
- 7) Installation of the evaluated products shall comply with this report, the FBC, and the manufacturer's published application instructions. Where discrepancies exist between these sources, the more restrictive and code compliant detail shall prevail.
- 8) All products listed in this report shall be manufactured under a quality assurance program in compliance with Rule 61G20-3.

COMPLIANCE STATEMENT

The products evaluated herein by Zachary R. Priest, P.E. have demonstrated compliance with the Florida Building Code, 6th Edition (2017) as evidenced in the referenced documents submitted by the named manufacturer.

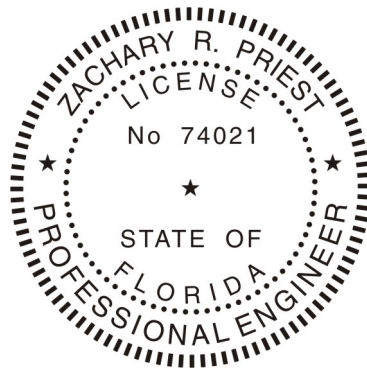

Zachary R. Priest, P.E.
 Florida Registration No. 74021
 Organization No. ANE9641

CERTIFICATION OF INDEPENDENCE

CREEK Technical Services, LLC does not have, nor will it acquire, a financial interest in any company manufacturing or distributing products under this evaluation.

CREEK Technical Services, LLC is not owned, operated, or controlled by any company manufacturing or distributing products under this evaluation.

Zachary R. Priest, P.E. does not have, nor will acquire, a financial interest in any company manufacturing or distributing products under this evaluation.

Zachary R. Priest, P.E. does not have, nor will acquire, a financial interest in any other entity involved in the approval process of the product.

END OF REPORT