



**ASTM E1886 and ASTM E1996 TEST REPORT**

**Report No.:** E4545.05-801-44

**Rendered to:**

GlassCraft Door Company  
Houston, Texas

**PRODUCT TYPE:** Inswing 8'0" Triple Fiberglass Door Glazed  
**SERIES/MODEL:** Inswing 8'0" Triple Fiberglass Door Glazed



Texas Firm F-11869

*John H. Waskow P.E.*  
Digitally Signed by: John H. Waskow

2015.08.12 16:05:56 -05'00'



*Tyler Westerling*  
Digitally Signed by: Tyler Westerling

2015.08.12 11:23:49 -07'00'

**Test Date(s):** 01/19/15  
**Through:** 07/08/15  
**Report Date:** 07/14/15  
**Revision 2:** 08/10/19

**Test Record Retention End Date:** 07/08/19

- 1.0 Report Issued To:** GlassCraft Door Company  
2002 Brittmoore Street  
Houston, Texas 77043
- 2.0 Test Laboratory:** Architectural Testing, Inc., an Intertek company ("Intertek-ATI")  
1909 10<sup>th</sup> Street  
Plano, Texas 75074  
(469) 814-0687
- 3.0 Project Summary:**
- 3.1 Product Type:** Inswing 8'0" Triple Fiberglass Door Glazed
- 3.2 Series/Model:** Inswing 8'0" Triple Fiberglass Door Glazed
- 3.3 Compliance Statement:** Results obtained are tested values and were secured by using the designated test method(s). The specimen(s) tested met the performance requirements set forth in the referenced test procedures for a  $\pm 2394$  Pa ( $\pm 50$  psf) Design Pressure with missile impacts corresponding to Missile Level D and Wind Zone 3.
- 3.4 Test Date(s):** 01/19/15 – 07/08/15
- 3.5 Test Record Retention End Date:** All test records for this report will be retained until July 8, 2019.
- 3.6 Test Location:** Intertek-ATI test facility in Plano, Texas.
- 3.7 Test Specimen Source:** The test specimen(s) were provided by the client. Representative samples of the test specimen(s) will be retained by Intertek-ATI for a minimum of four years from the test completion date.
- 3.8 Drawing Reference:** The test specimen drawings have been reviewed by Intertek-ATI and are representative of the test specimen(s) reported herein. Test specimen construction was verified by Intertek-ATI per the drawings located in Appendix B. Any deviations are documented herein or on the drawings.

**3.0 Project Summary: (Continued)**

**3.9 List of Official Observers:**

<u>Name</u>	<u>Company</u>
Clint Barnett	Intertek-ATI

**4.0 Test Specification(s):**

ASTM E1886-13a, *Standard Test Method for Performance of Exterior Windows, Curtain Walls, Doors, and Impact Protective Systems Impacted by Missile(s) and Exposed to Cyclic Pressure Differentials*

ASTM E1996-14a, *Standard Specification for Performance of Exterior Windows, Curtain Walls, Doors, and Impact Protective Systems Impacted by Windborne Debris in Hurricanes*

**5.0 Test Specimen Description:**

**5.1 Product Sizes:**

**Test Specimens #1 - #3:**

Overall Area: 8.2 m <sup>2</sup> (87.80 ft <sup>2</sup> )	Width		Height	
	millimeters	inches	millimeters	inches
Overall size	3278	129	2489	98
Double Door	1892	74-1/2	2438	98
Double Door Unglazed Leaf	914	36	2438	96
Double Door Glazed Leaf	902	35-1/2	2438	96
Single Door With Sidelite	1353	53-1/4	2489	98
Single Door Glazed Leaf	914	36	2438	96
Single Door Fixed Side Lite	356	14	2438	96

## 5.0 Test Specimen Description: (Continued)

### 5.2 Frame Construction:

Frame Member	Material	Description
Head and jambs	Fiberglass	1-1/4" x 4-5/8" cross section
Threshold	Aluminum-clad vinyl composite with extruded vinyl trim	6" wide with slope towards exterior.

	Joinery Type	Detail
All corners	Screwed partial rabbet	Secured with four #9 x 3" wood screws

### 5.3 Panel Construction:

Frame Member	Material	Description
All members	Fiberglass	Fiberglass panels filled with foam

	Joinery Type	Detail
All corners	Glued	Panels were backed with foam

### 5.4 Reinforcement: No reinforcement was utilized.



**5.0 Test Specimen Description: (Continued)**

**5.5 Weatherstripping:**

Description	Quantity	Location
U-shaped foam-filled vinyl gasket with kerf insert	1 Row	Shoulder of the jambs and header
Five fin rubber door sweep	1 Row	Threshold face of leaf

**5.6 Glazing:** *No conclusions of any kind regarding the adequacy or inadequacy of the glass in any glazed test specimen(s) can be made.*

Glass Type	Spacer Type	Interior Lite	Exterior Lite	Glazing Method
1" IG	1/2" Aluminum box	1/8" Tempered	1/8" Annealed-0.09" PVB Inerlayer-1/8" Annealed	Exterior wet glazed

Location	Quantity	Daylight Opening		Glass Bite
		millimeters	inches	
Glazed Doors	2	521 x 1600	20-1/2 x 63	0.50"
Side Lite	1	178 x 1600	7 x 63	0.50"

**5.7 Drainage:** Sloped threshold was utilized.

## 5.0 Test Specimen Description: (Continued)

### 5.8 Hardware:

Description	Quantity	Location
Door hinge	12	12" and 28" from bottom; 9" and 34-1/2" from top; attached with two #9 x 3" and two #9 x 1" wood screws
3 point lock set	2	Inserted into lock stile of operable leaf, secured with nine #8 x 3" wood screws at 7-3/8", 14-1/4", 17-9/16", 26-5/16", 45-13/16", 55-13/16", 62-3/16", 65-7/16" and 72-3/4" from bottom
Strike plate	12	On lock jamb in line with 3 point lock and dead bolt; secured with two #9 x 3" wood screws each
Flush Bolt	4	Top and bottom of each operable door leaf

## 6.0 Installation:

The specimen was installed into a Spruce-Pine-Fir wood buck. The rough opening allowed for a 1/2" shim space. A 2 x 10 divider was installed in the buck to separate the double door from the single door with a sidelite.

Location	Anchor Description	Anchor Location
Jambs	#9 x 3" wood screws	12" from corners and center; through top and bottom mounting holes of hinges
Head and threshold	#9 x 3" wood screws	4" from corners, 12" on center thereafter

**7.0 Test Results:** The results are tabulated as follows:

**ASTM E1886, Large Missile**

**Conditioning Temperature:** 21°C (70°F)

**Missile Weight:** 4173 g (9.20 lbs)

**Missile Length:** 2.4 m (8'0")

**Muzzle Distance from Test Specimen:** 5.2 m (17' 0")

**Test Unit #1:** Orientation within ±5° of horizontal

<b>Impact #1:</b> Missile Velocity: 15.51 m/s (50.90 fps)	
<b>Impact Area:</b>	Center of opaque door panel
<b>Observations:</b>	Missile hit target area, no ruptures or penetrations.
<b>Results:</b>	Pass

**Test Unit #1:** Orientation within ±5° of horizontal

<b>Impact #2:</b> Missile Velocity: 15.30 m/s (50.20 fps)	
<b>Impact Area:</b>	Center of double door glazed panel
<b>Observations:</b>	Missile hit target area, no ruptures or penetrations.
<b>Results:</b>	Pass

**Test Unit #1:** Orientation within ±5° of horizontal

<b>Impact #3:</b> Missile Velocity: 15.30 m/s (50.20 fps)	
<b>Impact Area:</b>	Center of single glazed door with side lite
<b>Observations:</b>	Missile hit target area, no ruptures or penetrations.
<b>Results:</b>	Pass

**Note:** See Intertek-ATI Sketch #1 for impact locations.

## 7.0 Test Results: (Continued)

### ASTM E1886, Large missile

**Conditioning Temperature:** 21°C (70°F)

**Missile Weight:** 4173 g (9.20 lbs)

**Missile Length:** 2.4 m (8'0")

**Muzzle Distance from Test Specimen:** 5.2 m (17' 0")

**Test Unit #2:** Orientation within  $\pm 5^\circ$  of horizontal

Impact #1: Missile Velocity: 15.51 m/s (50.90 fps)	
<b>Impact Area:</b>	Top right corner of opaque door panel
<b>Observations:</b>	Missile hit target area, no ruptures or penetrations.
<b>Results:</b>	Pass

**Test Unit #2:** Orientation within  $\pm 5^\circ$  of horizontal

Impact #2: Missile Velocity: 15.30 m/s (50.20 fps)	
<b>Impact Area:</b>	Top right corner of glazing on the double door
<b>Observations:</b>	Missile hit target area, no ruptures or penetrations.
<b>Results:</b>	Pass

**Test Unit #2:** Orientation within  $\pm 5^\circ$  of horizontal

Impact #3: Missile Velocity: 15.30 m/s (50.20 fps)	
<b>Impact Area:</b>	Top right corner of glazing on the single glazed door with side lite
<b>Observations:</b>	Missile hit target area, no ruptures or penetrations.
<b>Results:</b>	Pass

**Note:** See Intertek-ATI Sketch #2 for impact locations.

**7.0 Test Results:** (Continued)

**ASTM E1886, Large missile**

**Conditioning Temperature:** 21°C (70°F)

**Missile Weight:** 4173 g (9.20 lbs)

**Missile Length:** 2.4 m (8'0")

**Muzzle Distance from Test Specimen:** 5.2 m (17' 0")

**Test Unit #3:** Orientation within ±5° of horizontal

<b>Impact #1:</b> Missile Velocity: 15.51 m/s (50.90 fps)	
<b>Impact Area:</b>	Bottom left corner of opaque door panel
<b>Observations:</b>	Missile hit target area, no ruptures or penetrations.
<b>Results:</b>	Pass

**Test Unit #3:** Orientation within ±5° of horizontal

<b>Impact #2:</b> Missile Velocity: 15.30 m/s (50.20 fps)	
<b>Impact Area:</b>	Bottom left corner of glazing on the double door
<b>Observations:</b>	Missile hit target area, no ruptures or penetrations.
<b>Results:</b>	Pass

**Test Unit #3:** Orientation within ±5° of horizontal

<b>Impact #3:</b> Missile Velocity: 15.30 m/s (50.20 fps)	
<b>Impact Area:</b>	Bottom left corner of glazing on the door with side lite
<b>Observations:</b>	Missile hit target area, no ruptures or penetrations.
<b>Results:</b>	Pass

**Note:** See Intertek-ATI Sketch #3 for impact locations.



**7.0 Test Results:** (Continued)

**ASTM E1886, Air Pressure Cycling**

**Test Unit #1**

**Design Pressure:** ±2394 Pa (±50 psf)

**POSITIVE PRESSURE**

<b>Pressure Range Pa (psf)</b>	<b>Number of Cycles</b>	<b>Average Cycle Time (seconds)</b>	<b>Observations</b>
479 to 1197 (10 to 25)	3500	2.25	No damage beyond the allowable.
0 to 1436 (0 to 30)	300	2.50	No damage beyond the allowable.
1197 to 1915 (25 to 40)	600	2.49	No damage beyond the allowable.
718 to 2394 (15 to 50)	100	2.80	No damage beyond the allowable.

**NEGATIVE PRESSURE**

<b>Pressure Range Pa (psf)</b>	<b>Number of Cycles</b>	<b>Average Cycle Time (seconds)</b>	<b>Observations</b>
718 to 2394 (15 to 50)	50	2.80	No damage beyond the allowable.
1197 to 1915 (25 to 40)	1050	2.50	No damage beyond the allowable.
0 to 1436 (0 to 30)	50	3.00	No damage beyond the allowable.
479 to 1197 (10 to 25)	3350	2.40	No damage beyond the allowable.

**Result:** Pass

**7.0 Test Results:** (Continued)**ASTM E1886, Air Pressure Cycling****Test Unit #2****Design Pressure:**  $\pm 2394$  Pa ( $\pm 50$  psf)**POSITIVE PRESSURE**

<b>Pressure Range Pa (psf)</b>	<b>Number of Cycles</b>	<b>Average Cycle Time (seconds)</b>	<b>Observations</b>
479 to 1197 (10 to 25)	3500	1.78	No damage beyond the allowable.
0 to 1436 (0 to 30)	300	2.03	No damage beyond the allowable.
1197 to 1915 (25 to 40)	600	1.90	No damage beyond the allowable.
718 to 2394 (15 to 50)	100	2.17	No damage beyond the allowable.

**NEGATIVE PRESSURE**

<b>Pressure Range Pa (psf)</b>	<b>Number of Cycles</b>	<b>Average Cycle Time (seconds)</b>	<b>Observations</b>
718 to 2394 (15 to 50)	50	2.62	No damage beyond the allowable.
1197 to 1915 (25 to 40)	1050	1.95	No damage beyond the allowable.
0 to 1436 (0 to 30)	50	2.17	No damage beyond the allowable.
479 to 1197 (10 to 25)	3350	1.81	No damage beyond the allowable.

**Result:** Pass

**7.0 Test Results:** (Continued)**ASTM E1886, Air Pressure Cycling****Test Unit #3****Design Pressure:**  $\pm 2394$  Pa ( $\pm 50$  psf)**POSITIVE PRESSURE**

<b>Pressure Range Pa (psf)</b>	<b>Number of Cycles</b>	<b>Average Cycle Time (seconds)</b>	<b>Observations</b>
479 to 1197 (10 to 25)	3500	2.02	No damage beyond the allowable.
0 to 1436 (0 to 30)	300	2.50	No damage beyond the allowable.
1197 to 1915 (25 to 40)	600	1.82	No damage beyond the allowable.
718 to 2394 (15 to 50)	100	3.00	No damage beyond the allowable.

**NEGATIVE PRESSURE**

<b>Pressure Range Pa (psf)</b>	<b>Number of Cycles</b>	<b>Average Cycle Time (seconds)</b>	<b>Observations</b>
718 to 2394 (15 to 50)	50	3.00	No damage beyond the allowable.
1197 to 1915 (25 to 40)	1050	2.77	No damage beyond the allowable.
0 to 1436 (0 to 30)	50	3.00	No damage beyond the allowable.
479 to 1197 (10 to 25)	3350	2.56	No damage beyond the allowable.

**Result:** Pass

**General Note:** Upon completion of testing, the specimens met the requirements of Section 7 of ASTM E1996.

#### 8.0 Test Equipment:

**Cannon:** Constructed from steel piping utilizing compressed air to propel the missile

**Missile:** 2x4 Southern Pine

**Timing Device:** Electronic Beam Type

**Cycling Mechanism:** Computer controlled centrifugal blower with electronic pressure measuring device

Tape and film were used to seal against air leakage during structural testing. In our opinion, the tape and film did not influence the results of the test.

Intertek-ATI will service this report for the entire test record retention period. Test records such as detailed drawings, datasheets, representative samples of test specimens, or other pertinent project documentation, will be retained by Intertek-ATI for the entire test record retention period.

This report does not constitute certification of this product nor an opinion or endorsement by this laboratory. It is the exclusive property of the client so named herein and relates only to the specimen(s) tested. This report may not be reproduced, except in full, without the written approval of Intertek-ATI.

For ARCHITECTURAL TESTING, INC.:



Digitally Signed by: Clint Barnett

---

Clint Barnett  
Technician



Digitally Signed by: John H. Waskow

---

John H. Waskow, P.E.  
Director – Regional Operations



Digitally Signed by: Tyler Westerling

---

Tyler Westerling, P.E.  
Senior Project Engineer

CB:ac

Attachments (pages): This report is complete only when all attachments listed are included.

Appendix A: Sketch (3)

Appendix B: Drawing(s) (11)

This report produced from controlled document template ATI 00498, revised 06/19/15.



### Revision Log

<u>Rev. #</u>	<u>Date</u>	<u>Page(s)</u>	<u>Revision(s)</u>
1	07/24/15	Page 4	Changed frame material to fiberglass
2	08/10/15	Cover Page	Added a second P.E. Seal
2	08/10/15	Page 14	Added a third signature.

**Appendix A**

**Sketch(es)**

**Sketch #1 Impact Location test Specimen # 1**

129"

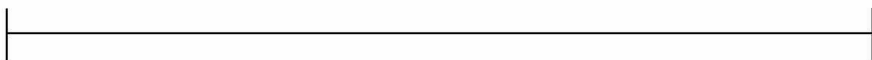
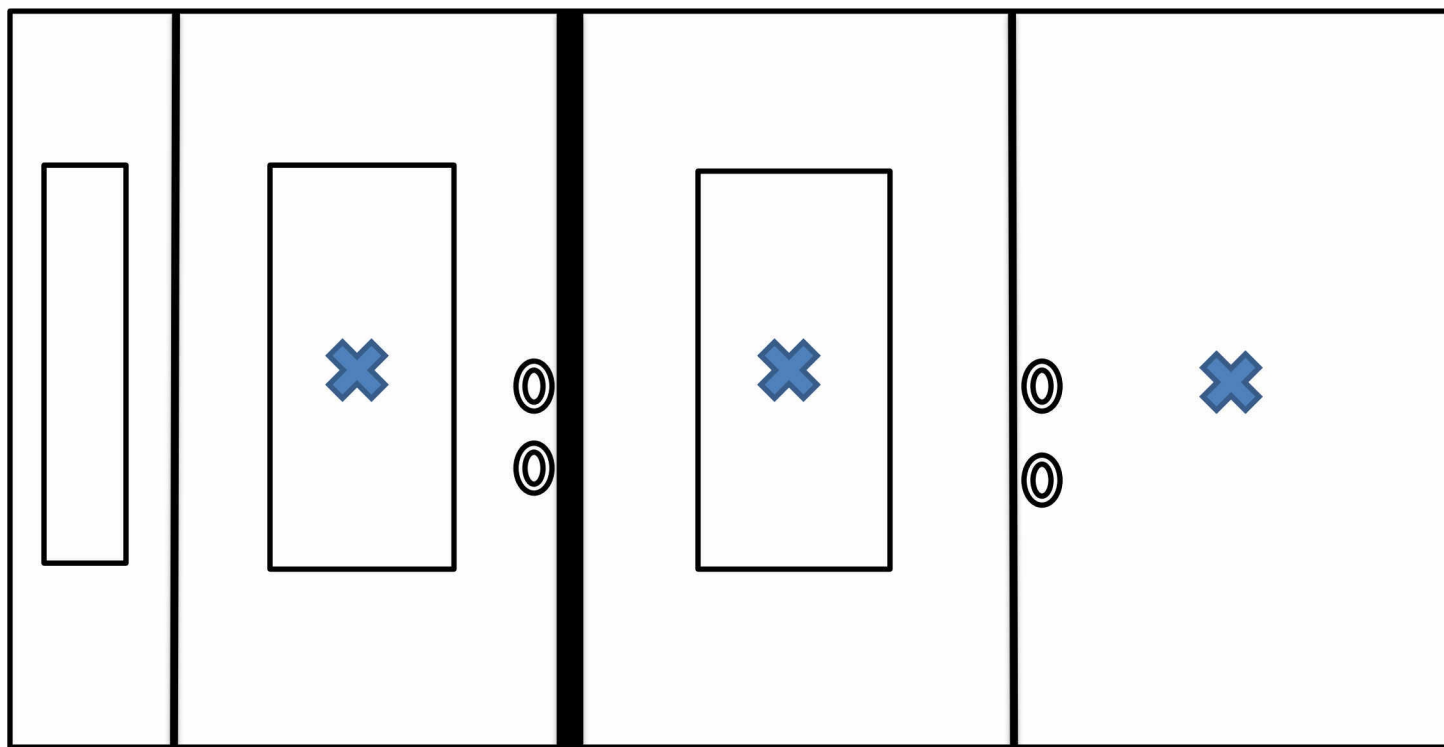

74"

**Sketch #2 Impact Location test Specimen # 2**

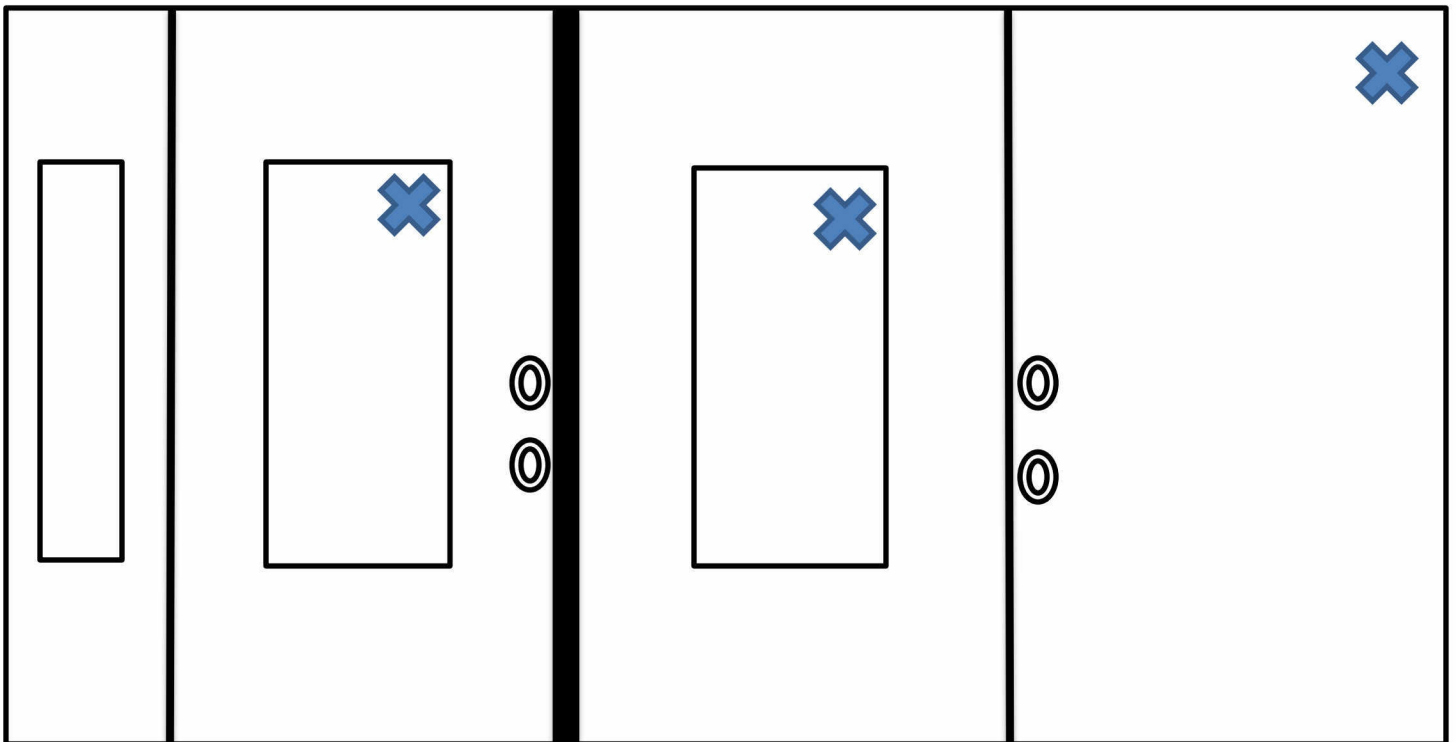

**Sketch #3 Impact Location test Specimen # 3**

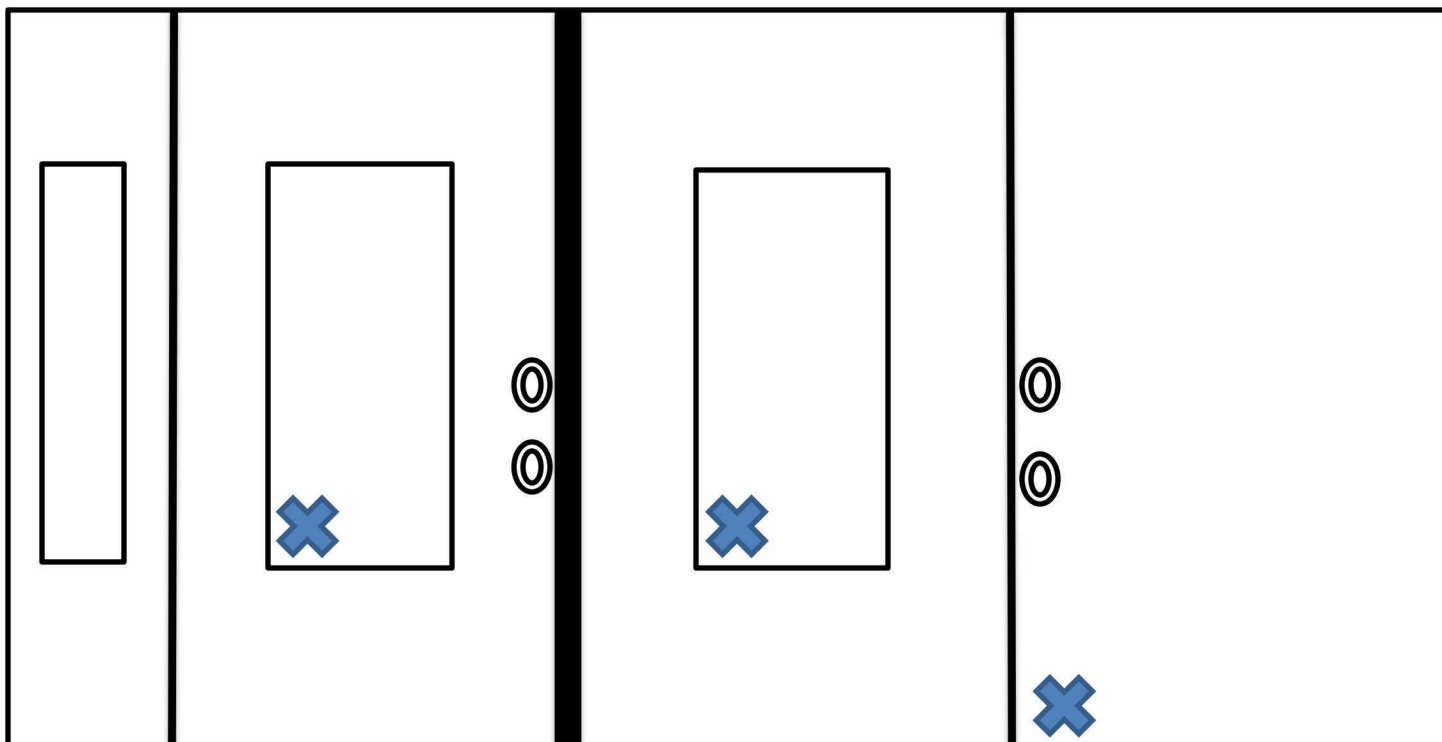

**Appendix B**

**Drawing(s)**



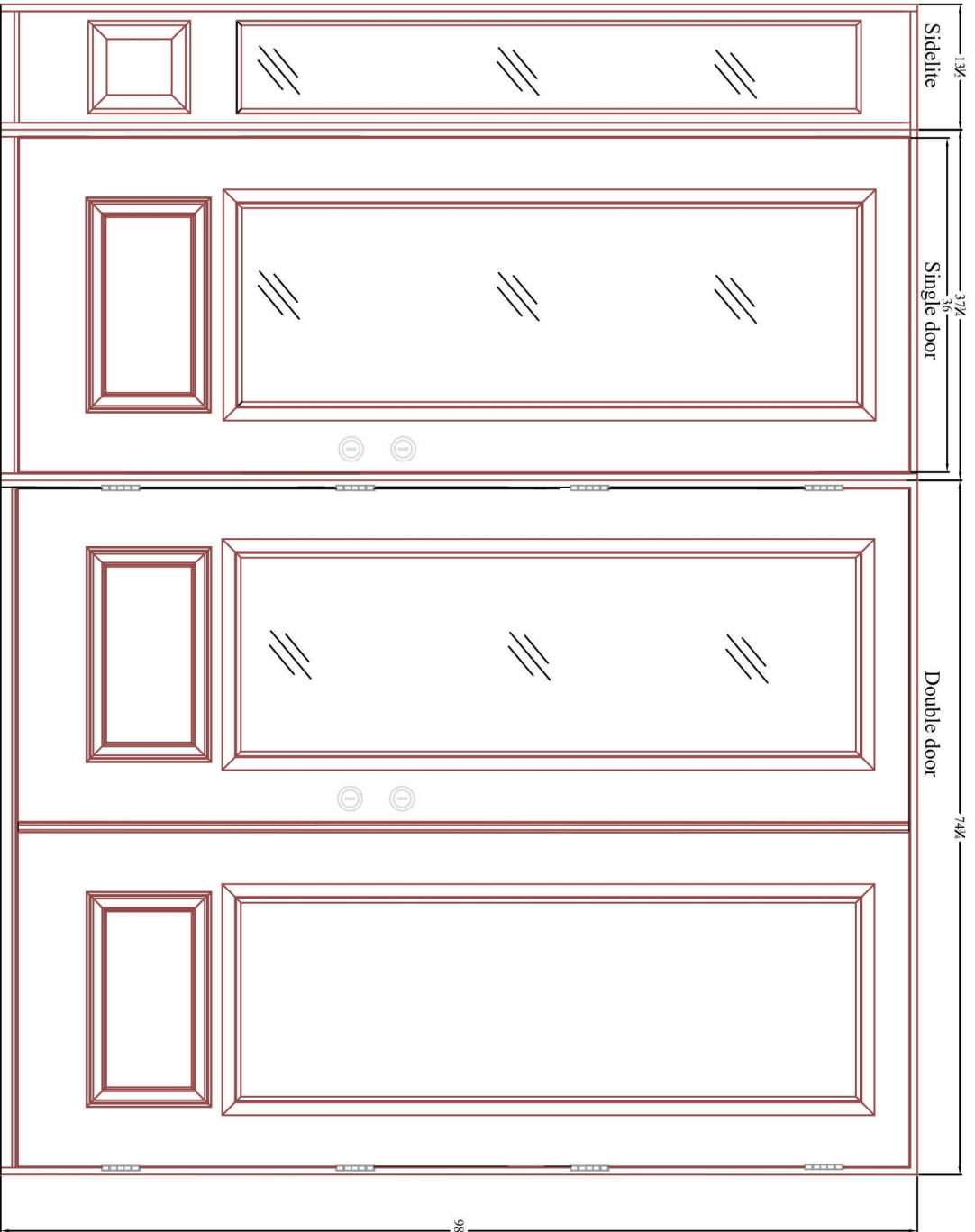
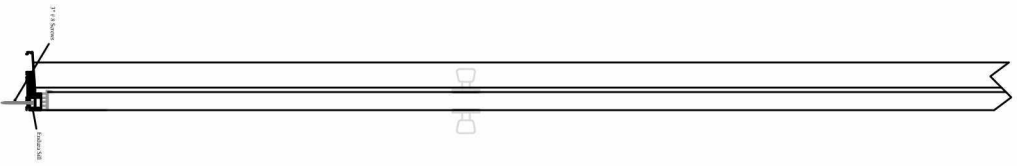



**Architectural Testing, Inc**  
 Test sample complies with details shown herein. Any deviations are noted in the test report or drawings.

Report #: E4545\_05  
 Date: 07/14/15 By: CB

**Out Swing**  
**ELEVATION**

Fiberglass Glazed Doors

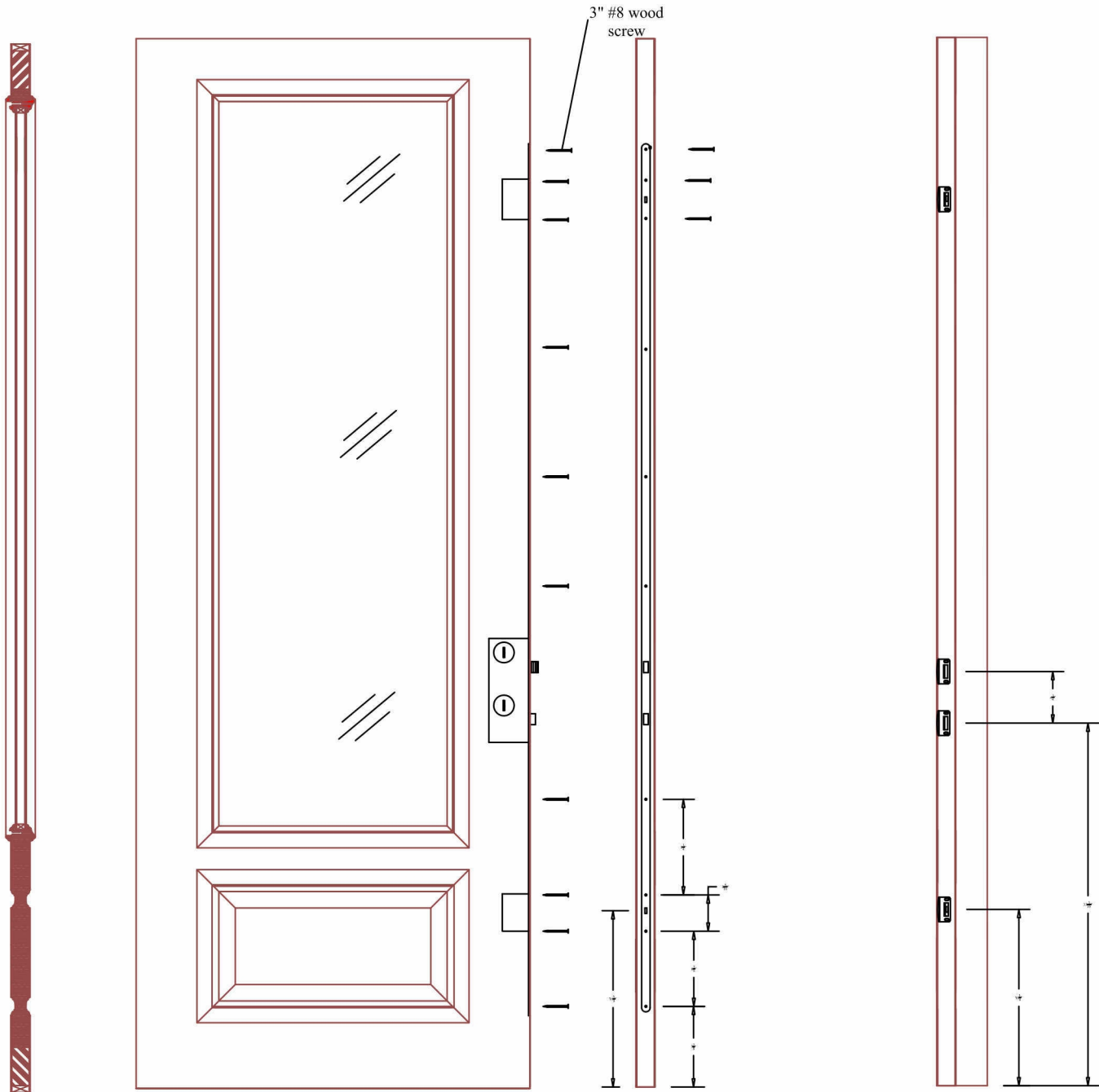
**Glass\*Craft**



## Three point lock set screw location and strike plate

**Glass\*Craft**  
Fiberglass Glazed Doors



Architectural Testing, Inc

Test sample complies with details shown herein. Any deviations are noted in the test report or drawings.

Report #: E4545\_05

Date: 07/14/15 By: CB

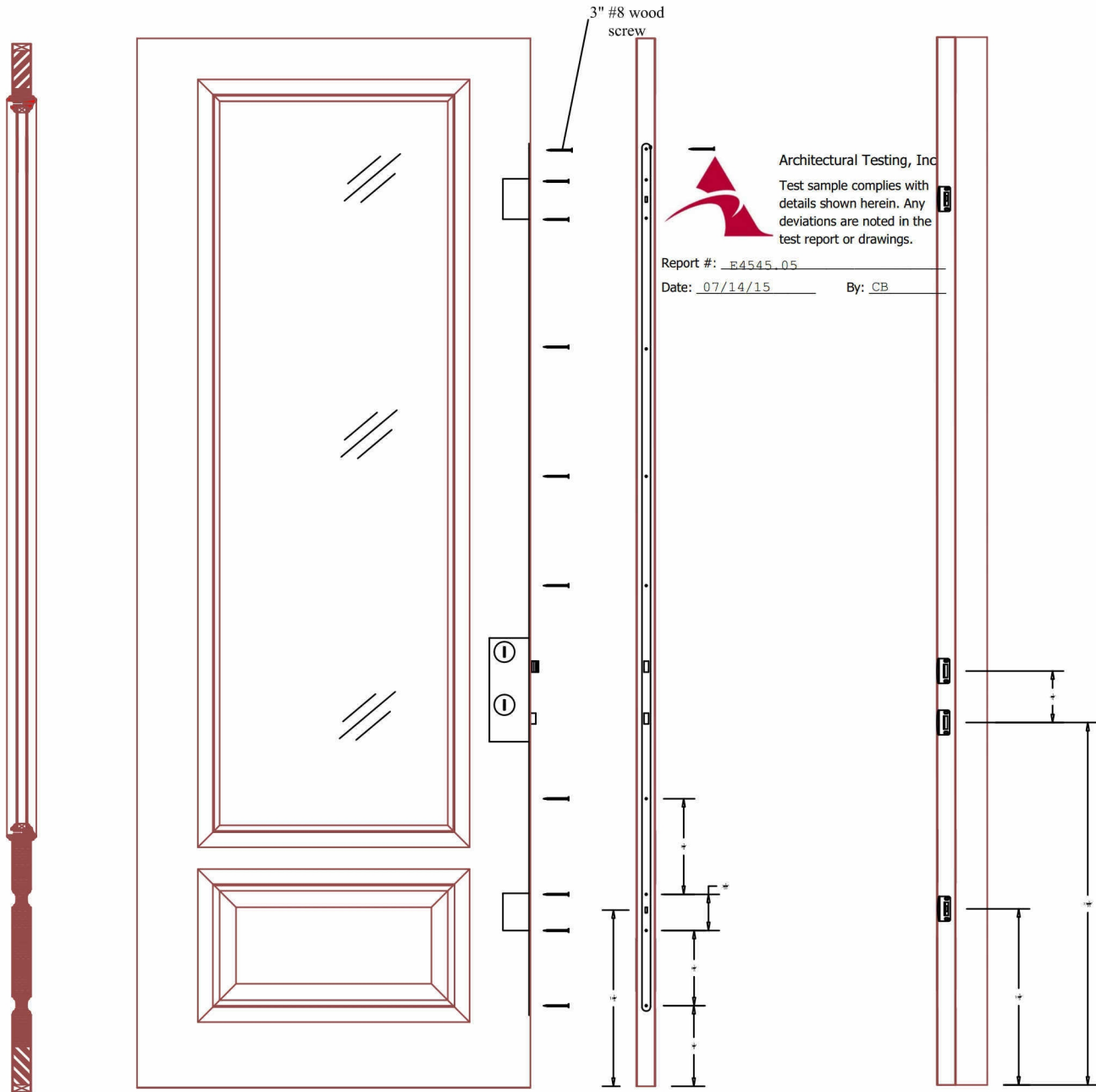

Architectural Testing, Inc  
 Test sample complies with  
 details shown herein. Any  
 deviations are noted in the  
 test report or drawings.

Report #: E4545.05  
 Date: 07/14/15 By: CB

Three point lock set screw  
 location and strike plate

**Glass\*Craft**  
 Fiberglass Glazed Doors

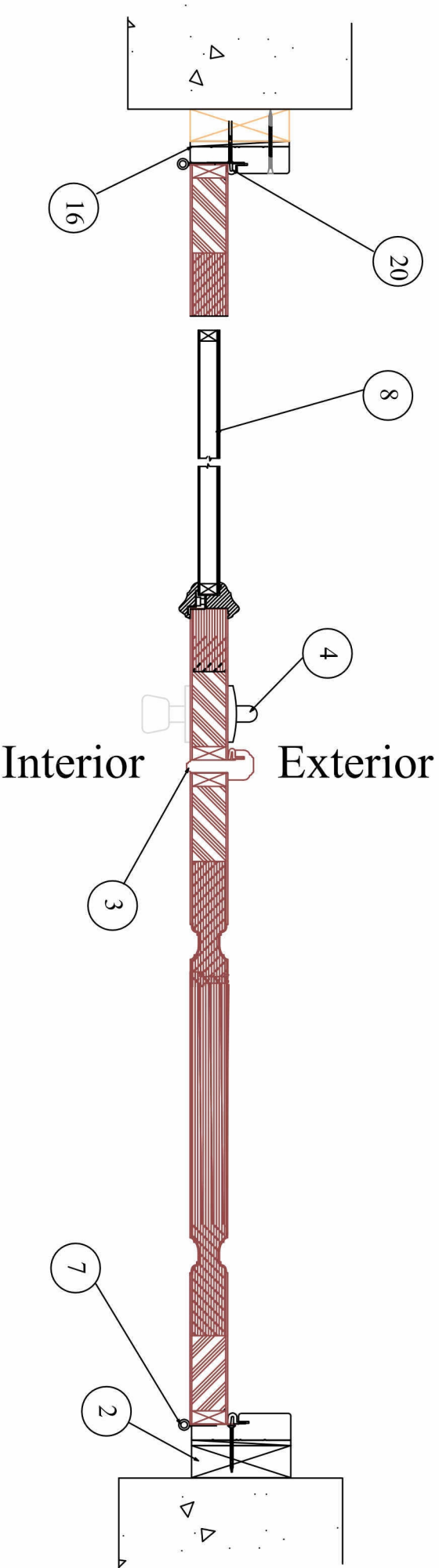

## Horizontal Cross Section



Architectural Testing, Inc  
 Test sample complies with  
 details shown herein. Any  
 deviations are noted in the  
 test report or drawings.

Report #: E45A5.05

Date: 07/14/15

By: CB

**Glass\*Craft**  
 Fiberglass Glazed Doors

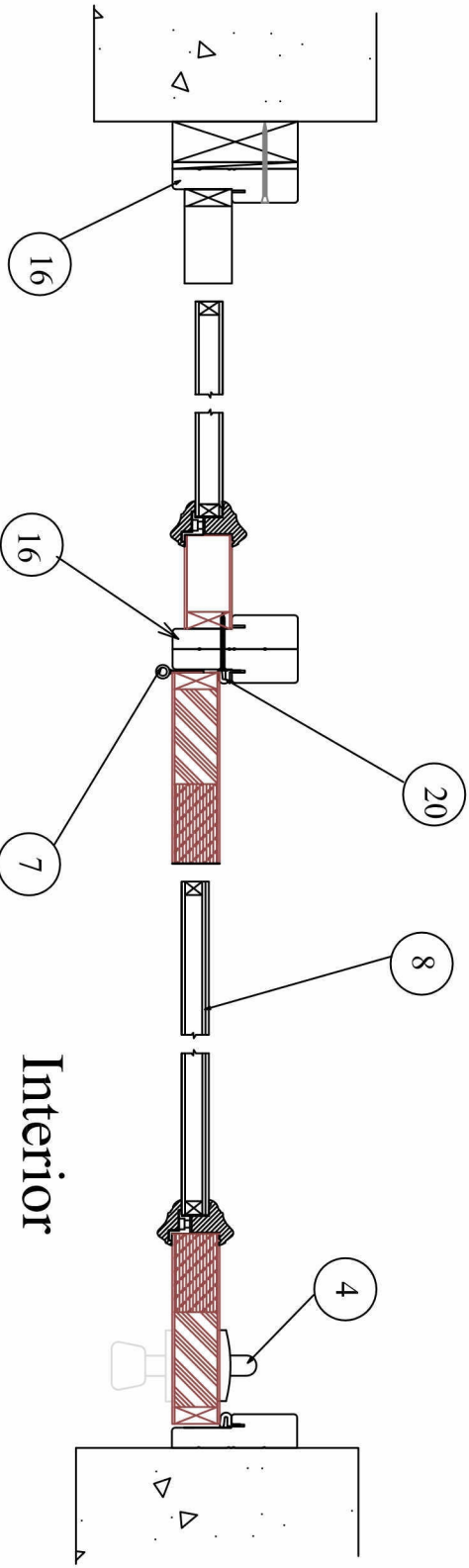

Architectural Testing, Inc  
 Test sample complies with  
 details shown herein. Any  
 deviations are noted in the  
 test report or drawings.

Report #: EA545.05  
 Date: 07/14/15 By: CB

**Glass\*Craft**



## List of Material

Item #	Description	Material
1	Masonry	CONC.
2	2x Buck	Wood
3	Astrical	Composite
4	Handal set	Metal
5	Imperial USA Ltd.	Metal
7	Penrond 4"x4" 5/8" Radius Hinge	Metal
8	Glass	Glass
10	Endura Sill ZAIL 5866 / I/S	Alum.
11	3" #9 Wood screw	Metal
12	#9x1" PFH Wood Screw	Metal
13	1/4 Round Trim	Composite
16	Door Jann	Composite
17	Bottom Door sweep	Rubber
18	10-32 Sex Bolt	Metal
20	weather strip	Foam
21	Endura Sill ZAIL 5866 / O/S	Alum.



Endura Sill  
ZAIL 5866 / I/S

(10)

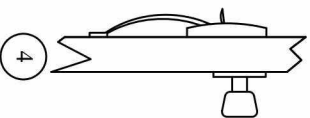

(4)

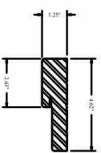

Door Jann (16)

(16)



weather strip (20)

(20)



Glass (8)

(8)



Astrical (3)

(3)

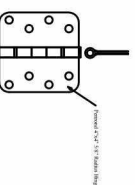

Penrond 4"x4" 5/8" Radius Hinge (7)

(7)



Bottom Door sweep (17)

(17)



Architectural Testing, Inc  
Test sample complies with  
details shown herein. Any  
deviations are noted in the  
test report or drawings.

Report #: E4545\_05

Date: 07/14/15

By: CB

**Glass\*Craft**  
Fiberglass Glazed Doors

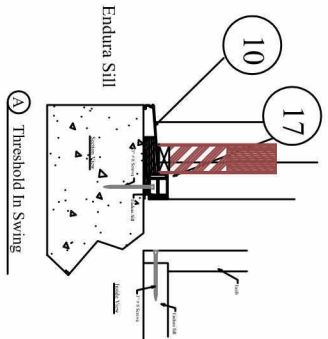

B Panel

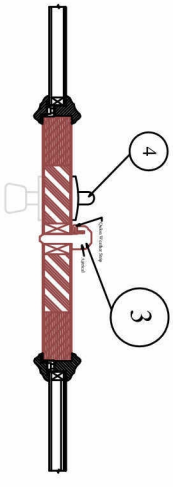
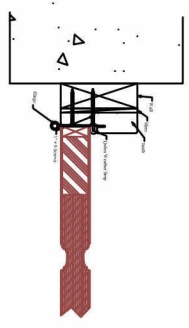

C Frame & Glass

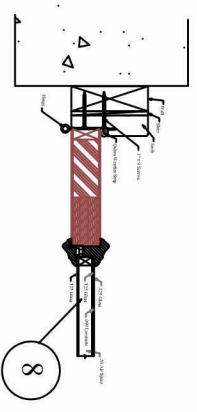

D Door Hinge

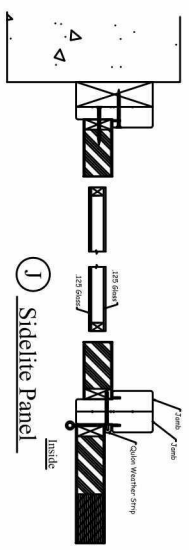

J Sidelite Panel

**Glass\*Craft**  
Single Door with Sidelite Using

# In Swing

## Glass\*Craft

Fiberglass Glazed Doors

Architectural Testing, Inc  
Test sample complies with details shown herein. Any deviations are noted in the test report or drawings.



Report #: A4545\_05

Date: 07/07/15 By: CB

Penrond 4"x4" 5/8" Radius Hinge

Install (2) 3" #8 Wood  
Screws Per Hinge.



Architectural Testing, Inc  
Test sample complies with  
details shown herein. Any  
deviations are noted in the  
test report or drawings.

Report #: FA545.05

Date: 07/14/15

By: CB

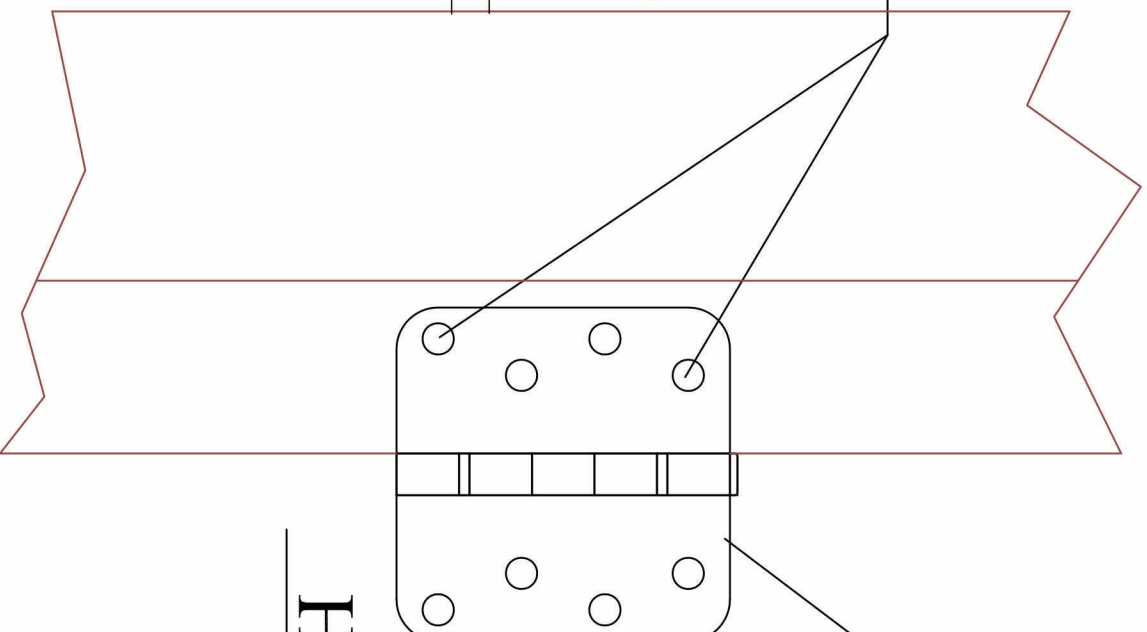

Hinge Detail

# Glass\*Craft

Fiberglass Glazed Doors

# See Hinge Detail

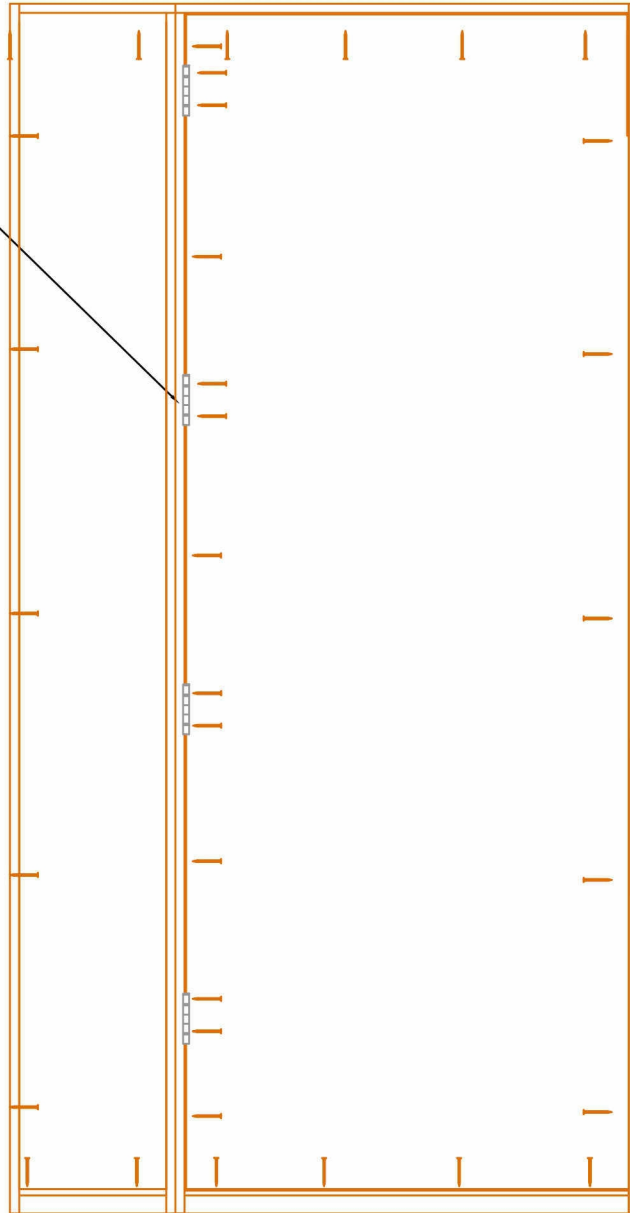

Architectural Testing, Inc  
Test sample complies with  
details shown herein. Any  
deviations are noted in the  
test report or drawings.

Report #: E4545.05

Date: 07/14/15 By: CB

## ANCHORING LOCATION

Fiberglass Glazed Doors

Single Door with Sidelites O/Sing

# Glass\*Craft

Architectural Testing, Inc  
Test sample complies with  
details shown herein. Any  
deviations are noted in the  
test report or drawings.  
Report #: B4545\_05  
Date: 07/14/15 By: CB

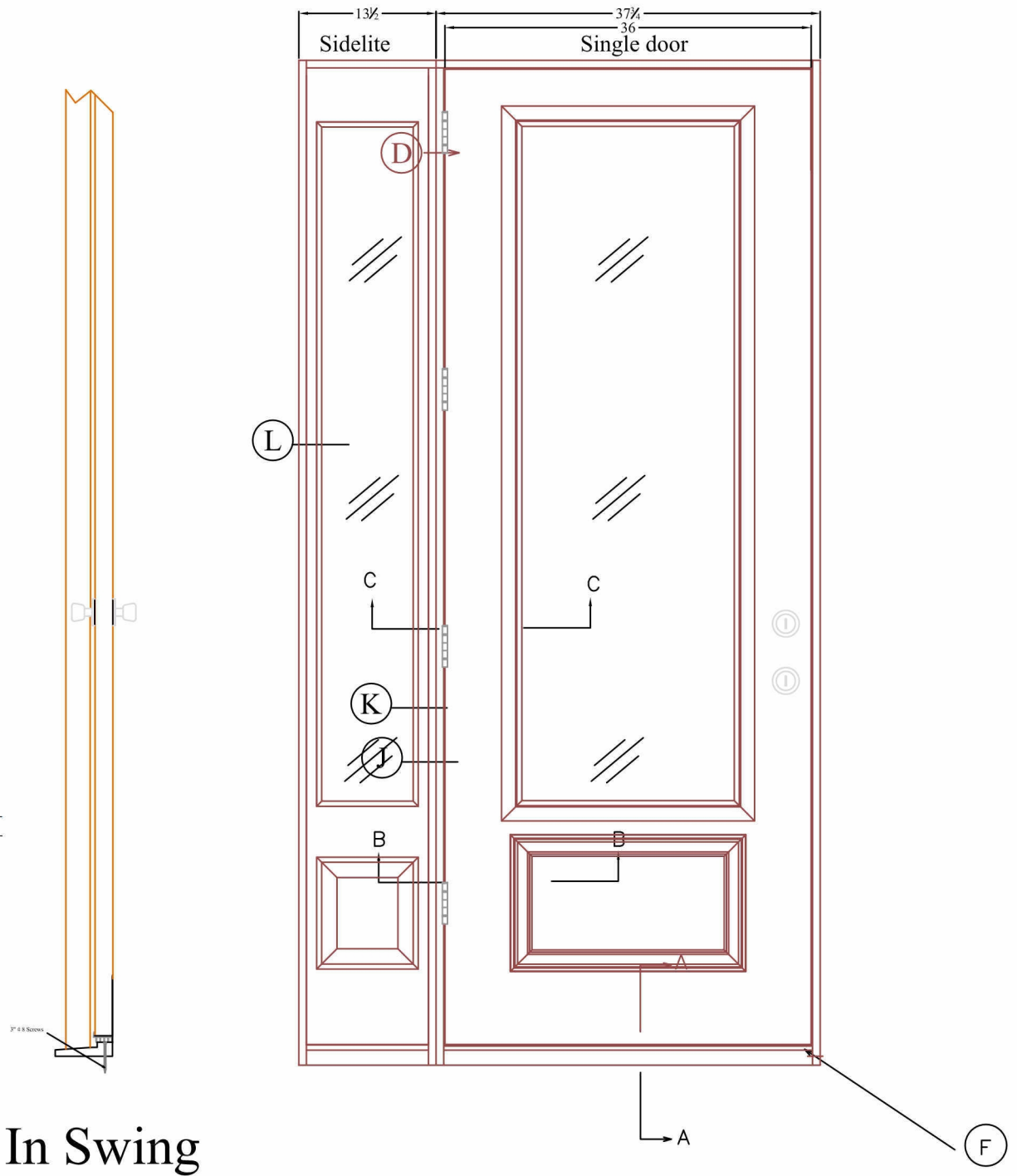

ELEVATION

**Glass\*Craft**

# Glass\*Craft

Fiberglass Glazed Doors

See Hinge Detail

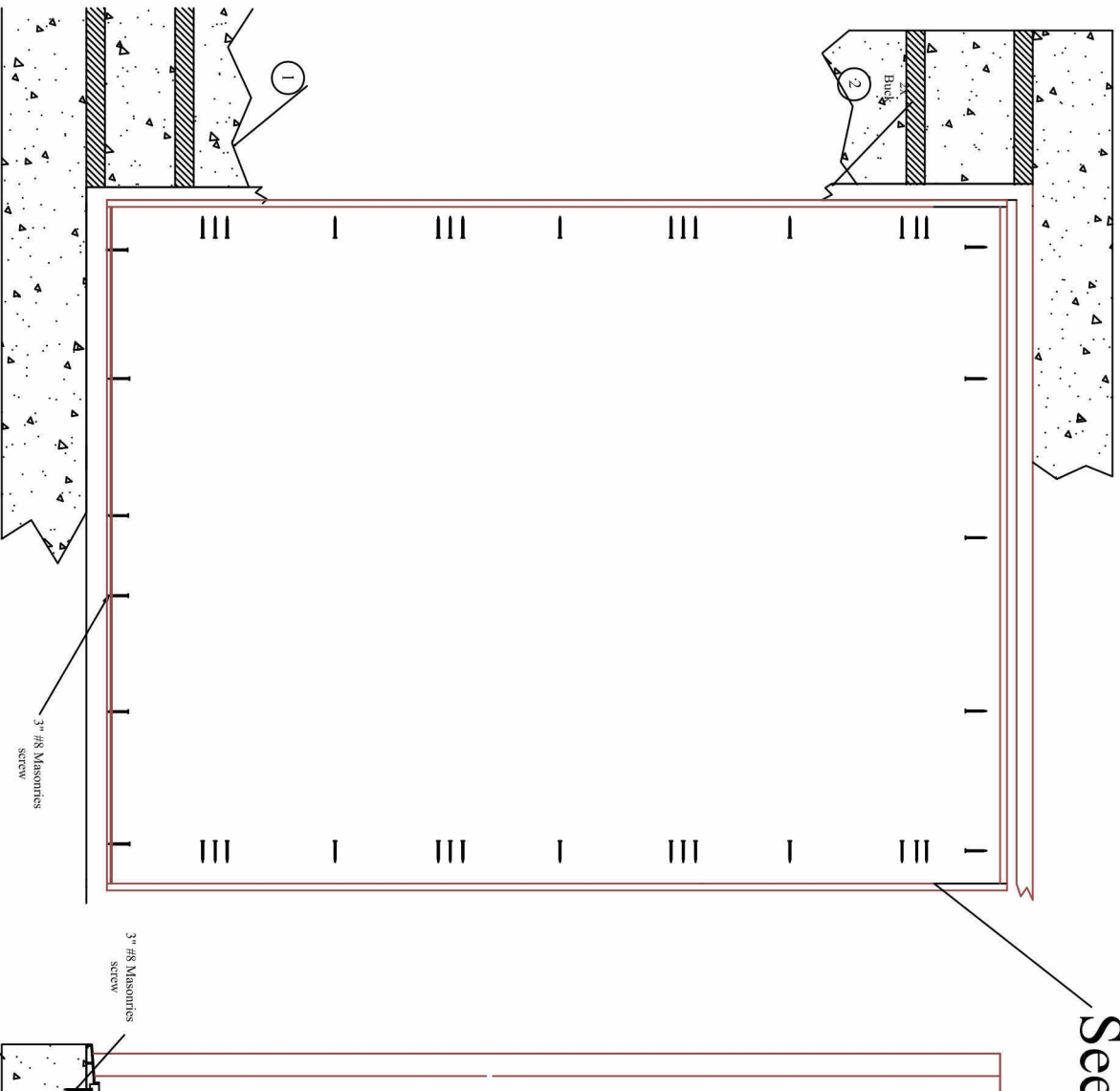

Architectural Testing, Inc  
Test sample complies with  
details shown herein. Any  
deviations are noted in the  
test report or drawings.

Report #: E4545.05  
Date: 07/14/15 By: CB

## ANCHORING LAYOUT

Set frame sill

