



ASTM E1886 and ASTM E1996 TEST REPORT

Report No.: E4545.02-801-44

Rendered to:

GlassCraft Door Company
Houston, Texas

PRODUCT TYPE: Outswing 8'0" Single Fiberglass Door with Speak Easy
SERIES/MODEL: Outswing 8'0" Single Fiberglass Door with Speak Easy



Texas Firm F-11869

John H. Waskow P.E.
Digitally Signed by: John H. Waskow

2015.08.12 16:29:05 -05'00'



Tyler Westerling
Digitally Signed by: Tyler Westerling

2015.08.12 11:20:52 -07'00'

Test Date(s): 02/02/15

Through: 02/05/15

Report Date: 07/13/15

Revision 2: 08/10/15

Record Retention End Date: 02/05/19

Report Issued To: GlassCraft Door Company

2002 Brittmore Street
Houston, Texas 77043

1.0 Test Laboratory: Architectural Testing, Inc., an Intertek company ("Intertek-ATI")
1909 10th Street
Plano, Texas 75074
(469) 814-0687

3.0 Project Summary:

3.1 Product Type: Outswing 8'0" Single Fiberglass Door with Speak Easy

3.2 Series/Model: Outswing 8'0" Single Fiberglass Door with Speak Easy

3.3 Compliance Statement: Results obtained are tested values and were secured by using the designated test method(s). The specimen(s) tested met the performance requirements set forth in the referenced test procedures for a ± 2394 Pa (± 50 psf) Design Pressure with missile impacts corresponding to Missile Level D and Wind Zone 3.

3.4 Test Date(s): 02/02/15 – 02/05/15

3.5 Test Record Retention End Date: All test records for this report will be retained until February 5, 2019.

3.6 Test Location: Intertek-ATI test facility in Plano, Texas.

3.7 Test Specimen Source: The test specimen(s) were provided by the client. Representative samples of the test specimen(s) will be retained by Intertek-ATI for a minimum of four years from the test completion date.

3.8 Drawing Reference: The test specimen drawings have been reviewed by Intertek-ATI and are representative of the test specimen(s) reported herein. Test specimen construction was verified by Intertek-ATI per the drawings located in Appendix B. Any deviations are documented herein or on the drawings.

3.0 Project Summary: (Continued)

3.9 List of Official Observers:

<u>Name</u>	<u>Company</u>
Clint Barnett	Intertek-ATI

4.0 Test Specification(s):

ASTM E1886-13a, *Standard Test Method for Performance of Exterior Windows, Curtain Walls, Doors, and Impact Protective Systems Impacted by Missile(s) and Exposed to Cyclic Pressure Differentials*

ASTM E1996-14a, *Standard Specification for Performance of Exterior Windows, Curtain Walls, Doors, and Impact Protective Systems Impacted by Windborne Debris in Hurricanes*

5.0 Test Specimen Description:

5.1 Product Sizes:

Test Specimens #1 - #3:

Overall Area: 2.4 m ² (25.52 ft ²)	Width		Height	
	millimeters	inches	millimeters	inches
Overall size	953	37-1/2	2489	98
Leaf	914	36	2438	96

5.2 Frame Construction:

Frame Member	Material	Description
Head and jambs	Fiberglass	1-1/4" x 4-5/8" cross section
Threshold	Aluminum-clad vinyl composite with extruded vinyl trim	6" wide with slope towards exterior.

	Joinery Type	Detail
All corners	Screwed partial rabbet	Secured with four #9 x 3" wood screws

5.0 Test Specimen Description: (Continued)

5.3 Panel Construction:

Frame Member	Material	Description
All members	Fiberglass	Fiberglass panels filled with foam

	Joinery Type	Detail
All corners	Glued	Panels were backed with foam

5.4 Reinforcement: No reinforcement was utilized.

5.5 Weatherstripping:

Description	Quantity	Location
U-shaped foam-filled vinyl gasket with kerf insert	1 Row	Shoulder of the jambs and header
Five fin rubber door sweep	1 Row	Threshold face of leaf

5.6 Glazing: *No conclusions of any kind regarding the adequacy or inadequacy of the glass in any glazed test specimen(s) can be made.*

Glass Type	Spacer Type	Interior Lite	Exterior Lite	Glazing Method
1" IG	1/2" Aluminum box	1/8" Annealed	1/8" Annealed-0.09" PVB Inerlayer-1/8" Annealed	Exterior wet glazed

Location	Quantity	Daylight Opening		Glass Bite
		millimeters	inches	
Speakeasy	1	152 x 292	6 x 11-1/2	1/2"

5.7 Drainage: Sloped threshold was utilized.

5.0 Test Specimen Description: (Continued)

5.8 Hardware:

Description	Quantity	Location
Door hinge	4	12" and 28" from bottom; 9" and 34-1/2" from top; attached with two #9 x 3" and two #9 x 1" wood screws
3 point lock set	1	Inserted into lock stile of operable leaf, secured with nine #8 x 3" wood screws at 7-3/8", 14-1/4", 17-9/16", 26-5/16", 45-13/16", 55-13/16", 62-3/16", 65-7/16" and 72-3/4" from bottom
Strike plate	4	On lock jamb in line with 3 point lock and dead bolt; secured with two #9 x 3" wood screws each
Latch	1 per leaf	Centered on speak easy lock stile
Keeper	1 per leaf	In line with latch, on speak easy frame
Hinge	2 per leaf	3" from top and bottom of speak easy

6.0 Installation:

The specimen was installed into a Spruce-Pine-Fir wood buck. The rough opening allowed for a 1/2" shim space.

Location	Anchor Description	Anchor Location
Jambs	#9 x 3" wood screws	12" from corners and center; through top and bottom mounting holes of hinges
Head and threshold	#9 x 3" wood screws	4" from corners, 12" on center thereafter

7.0 Test Results: The results are tabulated as follows:

ASTM E1886, Large

Conditioning Temperature: 21°C (70°F)

Missile Weight: 4173 g (9.20 lbs)

Missile Length: 2.4 m (8'0")

Muzzle Distance from Test Specimen: 5.2 m (17' 0")

Test Unit #1: Orientation within ±5° of horizontal

Impact #1: Missile Velocity: 15.51 m/s (50.90 fps)	
Impact Area:	Speak Easy Center
Observations:	Missile hit target area, no ruptures or penetrations.
Results:	Pass

Test Unit #2: Orientation within ±5° of horizontal

Impact #1: Missile Velocity: 15.39 m/s (50.50 fps)	
Impact Area:	Speak Easy Top Left
Observations:	Missile hit target area, no ruptures or penetrations.
Results:	Pass

Note: See Intertek-ATI Sketch #1 for impact locations.

7.0 Test Results: (Continued)

ASTM E1886, Large

Conditioning Temperature: 21°C (70°F)

Missile Weight: 4173 g (9.20 lbs)

Missile Length: 2.4 m (8'0")

Muzzle Distance from Test Specimen: 5.2 m (17' 0")

Test Unit #3: Orientation within $\pm 5^\circ$ of horizontal

Impact #1: Missile Velocity: 15.51 m/s (50.90 fps)	
Impact Area:	Speak Easy Bottom Right
Observations:	Missile hit target area, no ruptures or penetrations.
Results:	Pass

Note: See Intertek-ATI Sketch #1 for impact locations.

7.0 Test Results: (Continued)**ASTM E1886, Air Pressure Cycling****Test Unit #1****Design Pressure:** ± 2394 Pa (± 50 psf)**POSITIVE PRESSURE**

Pressure Range Pa (psf)	Number of Cycles	Average Cycle Time (seconds)	Observations
479 to 1197 (10 to 25)	3500	2.00	No damage beyond the allowable.
0 to 1436 (0 to 30)	300	2.00	No damage beyond the allowable.
1197 to 1915 (25 to 40)	600	2.00	No damage beyond the allowable.
718 to 2394 (15 to 50)	100	2.00	No damage beyond the allowable.

NEGATIVE PRESSURE

Pressure Range Pa (psf)	Number of Cycles	Average Cycle Time (seconds)	Observations
718 to 2394 (15 to 50)	50	2.00	No damage beyond the allowable.
1197 to 1915 (25 to 40)	1050	2.00	No damage beyond the allowable.
0 to 1436 (0 to 30)	50	2.00	No damage beyond the allowable.
479 to 1197 (10 to 25)	3350	2.00	No damage beyond the allowable.

Result: Pass

7.0 Test Results: (Continued)**ASTM E1886, Air Pressure Cycling****Test Unit #2****Design Pressure:** ± 2394 Pa (± 50 psf)**POSITIVE PRESSURE**

Pressure Range Pa (psf)	Number of Cycles	Average Cycle Time (seconds)	Observations
479 to 1197 (10 to 25)	3500	3.00	No damage beyond the allowable.
0 to 1436 (0 to 30)	300	2.00	No damage beyond the allowable.
1197 to 1915 (25 to 40)	600	3.00	No damage beyond the allowable.
718 to 2394 (15 to 50)	100	2.50	No damage beyond the allowable.

NEGATIVE PRESSURE

Pressure Range Pa (psf)	Number of Cycles	Average Cycle Time (seconds)	Observations
718 to 2394 (15 to 50)	50	2.50	No damage beyond the allowable.
1197 to 1915 (25 to 40)	1050	2.50	No damage beyond the allowable.
0 to 1436 (0 to 30)	50	2.50	No damage beyond the allowable.
479 to 1197 (10 to 25)	3350	2.50	No damage beyond the allowable.

Result: Pass

7.0 Test Results: (Continued)**ASTM E1886, Air Pressure Cycling****Test Unit #3****Design Pressure:** ± 2394 Pa (± 50 psf)**POSITIVE PRESSURE**

Pressure Range Pa (psf)	Number of Cycles	Average Cycle Time (seconds)	Observations
479 to 1197 (10 to 25)	3500	2.00	No damage beyond the allowable.
0 to 1436 (0 to 30)	300	2.50	No damage beyond the allowable.
1197 to 1915 (25 to 40)	600	2.50	No damage beyond the allowable.
718 to 2394 (15 to 50)	100	3.00	No damage beyond the allowable.

NEGATIVE PRESSURE

Pressure Range Pa (psf)	Number of Cycles	Average Cycle Time (seconds)	Observations
718 to 2394 (15 to 50)	50	3.00	No damage beyond the allowable.
1197 to 1915 (25 to 40)	1050	2.50	No damage beyond the allowable.
0 to 1436 (0 to 30)	50	2.50	No damage beyond the allowable.
479 to 1197 (10 to 25)	3350	2.50	No damage beyond the allowable.

Result: Pass

General Note: Upon completion of testing, the specimens met the requirements of Section 7 of ASTM E1996.

8.0 Test Equipment:

Cannon: Constructed from steel piping utilizing compressed air to propel the missile

Missile: 2x4 Southern Pine

Timing Device: Electronic Beam Type

Cycling Mechanism: Computer controlled centrifugal blower with electronic pressure measuring device

Tape and film were used to seal against air leakage during structural testing. In our opinion, the tape and film did not influence the results of the test.

Intertek-ATI will service this report for the entire test record retention period. Test records such as detailed drawings, datasheets, representative samples of test specimens, or other pertinent project documentation, will be retained by Intertek-ATI for the entire test record retention period.

This report does not constitute certification of this product nor an opinion or endorsement by this laboratory. It is the exclusive property of the client so named herein and relates only to the specimen(s) tested. This report may not be reproduced, except in full, without the written approval of Intertek-ATI.

For ARCHITECTURAL TESTING, INC.:



Digitally Signed by: Clint Barnett

Clint Barnett
Technician



Digitally Signed by: John H. Waskow

John H. Waskow, P.E.
Director – Regional Operations



Digitally Signed by: Tyler Westerling

Tyler Westerling, P.E.
Senior Project Engineer

CB:ac

Attachments (pages): This report is complete only when all attachments listed are included.

Appendix A: Sketch (1)

Appendix B: Drawing(s) (12)

This report produced from controlled document template ATI 00498, revised 06/19/15.

Revision Log

<u>Rev. #</u>	<u>Date</u>	<u>Page(s)</u>	<u>Revision(s)</u>
1	07/24/15	4	Changed frame material to fiberglass.
2	08/10/15	Cover Page	Changed California P.E. Seal to Florida
2	08/10/15	Cover Page	Added a Texas P.E. Seal.
2	08/10/15	Page 12	Added a third signature.

Appendix A

Sketch(es)

Sketch #1 Impact Locations

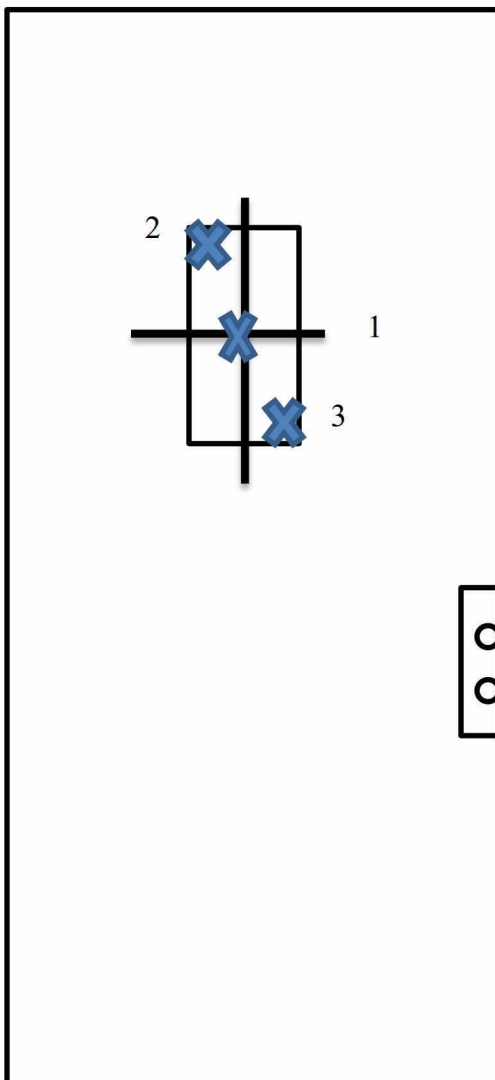

Appendix B

Drawing(s)

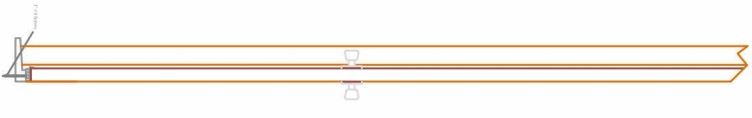

In Swing

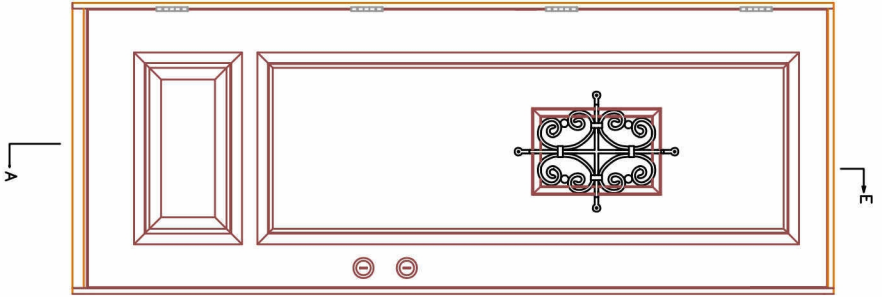

ELEVATION

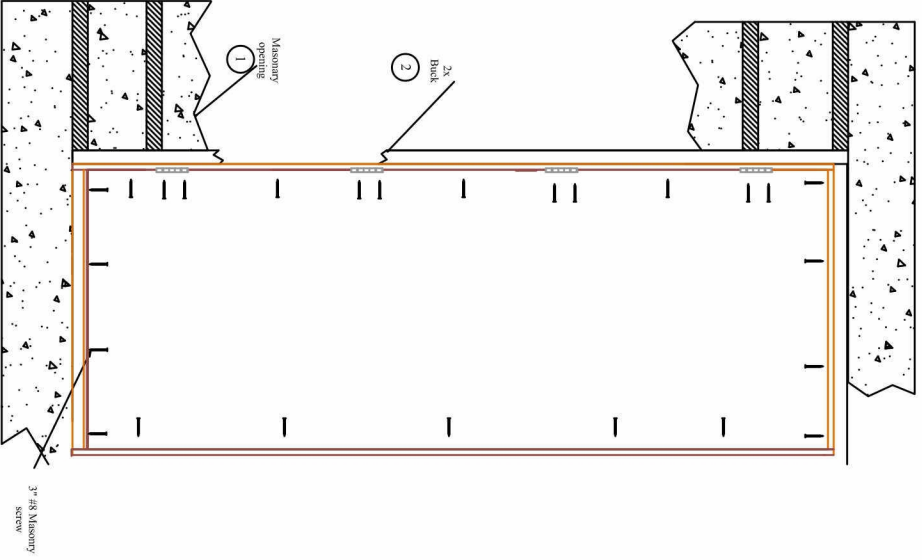

ANCHORING LAYOUT

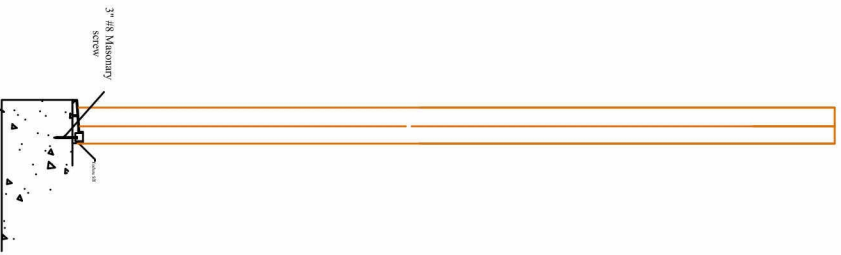

Set frame sill in concrete or bed of caulk

Impact Out-swing 8'-0" Fiberglass Door
 W//Speakeasy
 Inside View / Out swing

Glass*Craft



Architectural Testing, Inc

Test sample complies with details shown herein. Any deviations are noted in the test report or drawings.

Report #: E4545_01_02

Date: 07/14/15 By: CB

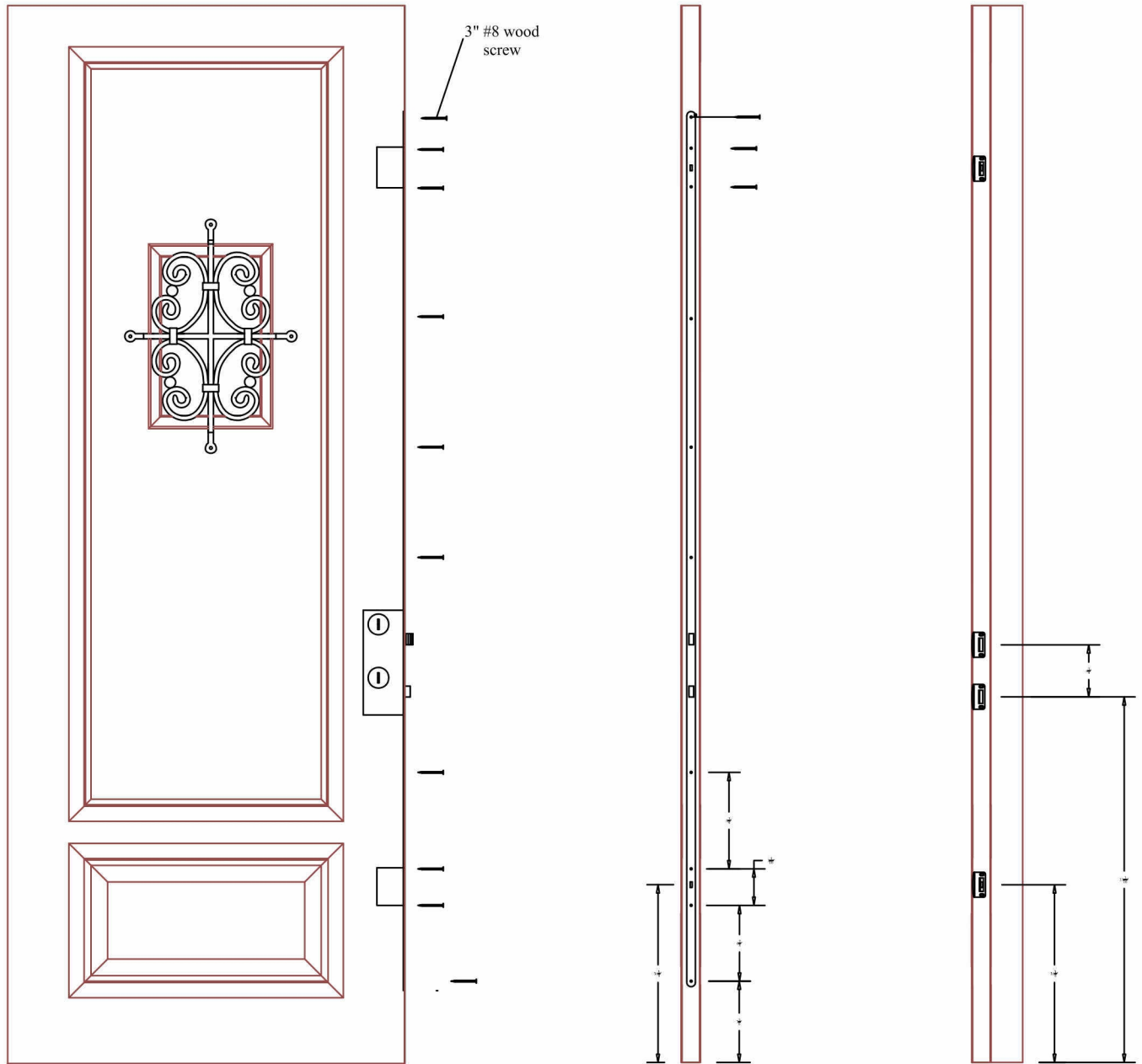

Three point lock set screw location and strike plate

Glass*Craft

Impact Fiberglass Glazed Doors

4

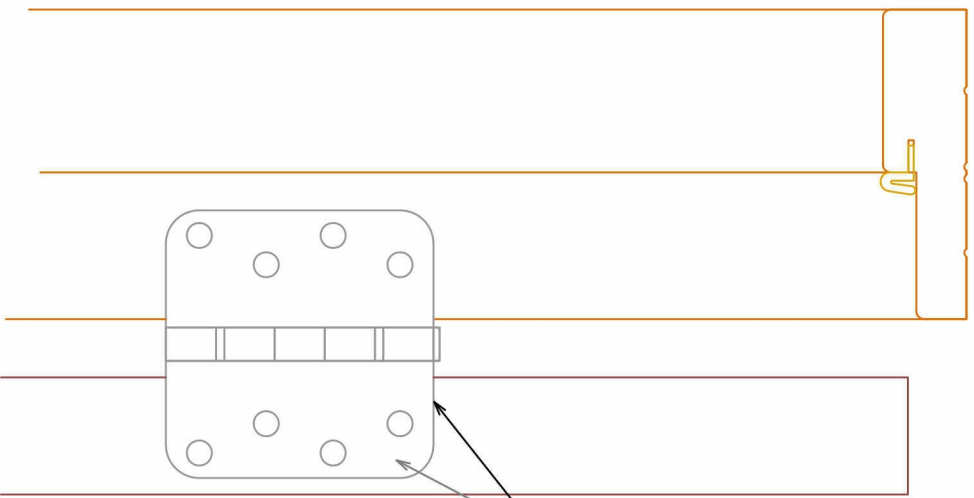

Pentron 4"x4" 5/8" Radius Hinge



Architectural Testing, Inc
Test sample complies with details shown herein. Any deviations are noted in the test report or drawings.

Report #: E4545.01, .02

Date: 07/14/15

By: CB

D

Door Hinge

Glass*Craft

Single 8'0 Fiberglass Door
/ Speakeasy Door

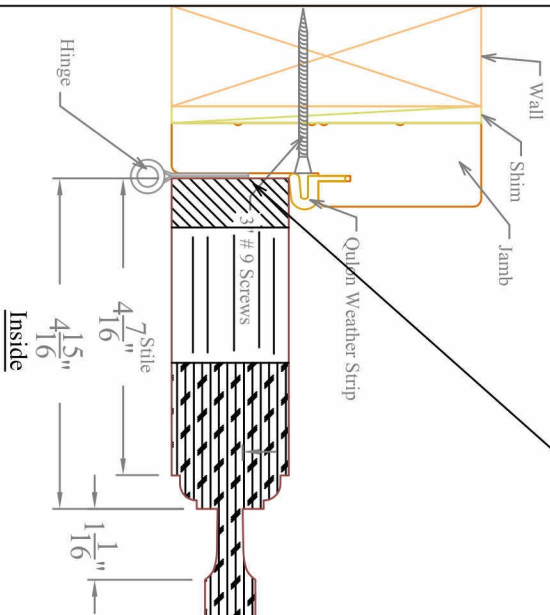
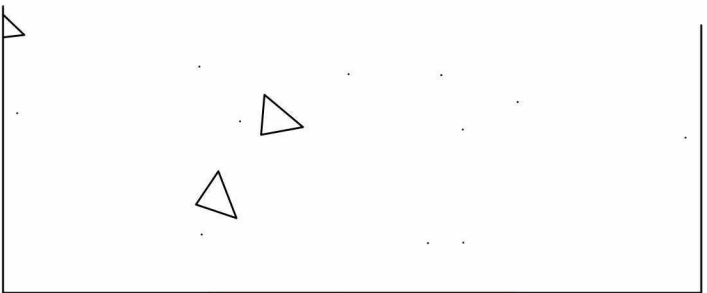

12

11



Architectural Testing, Inc
 Test sample complies with
 details shown herein. Any
 deviations are noted in the
 test report or drawings.

Report #: E4545.01.02
 Date: 07/14/15 By: CB

B

Panel

Glass*Craft

Single 8'0 Fiberglass Door
 / Speakeasy Door



17

10

Report #: E4545.01, .02

Date: 07/14/15 By: CB

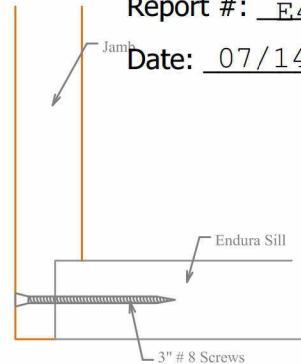

Inside View

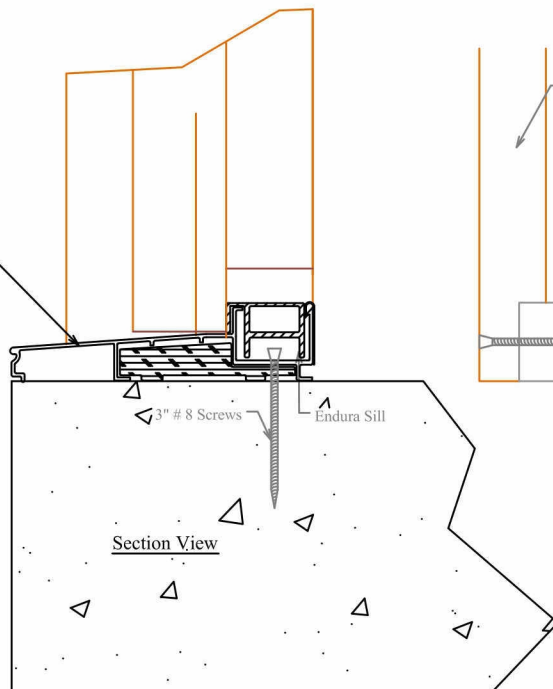

Section View

Endura Sill

(A) Threshold Out Swing

Glass*Craft

Single 8'0 Fiberglass Door / Speakeasy Door

Install Outside Housing

NOTE: Do not install adapter ring if using 1 1/2" (38 mm) hole.

- FOR F350/F352: Ensure pin is positioned to slide through correct backset slot in deadbolt.
- Insert housing through escutcheon and adapter ring and into door. Driver bar should slide under deadbolt.

Instalación del alojamiento exterior

NOTA: Si se usa un agujero de 38 mm no se instala un anillo adaptador.

- PARA LOS MODELOS F350/F352: Se debe verificar que el pasador está colocado de manera que se deslice a través de la ranura en el pasador que corresponde a la distancia correcta del borde de la puerta al centro de la bocallave.
- Introducir el alojamiento en la puerta, a través del escudo y del anillo adaptador. La barra impulsora debe deslizarse debajo del pasador.

Installation du logement extérieur

REMARQUE: Ne pas installer l'anneau adaptateur si le trou 38 mm est utilisé.

- POUR les modèles F350/F352: S'assurer que la broche est placée de sorte à glisser dans la fente d'écartement correct du pêne dormant.
- Insérer le logement par l'entrée de serrure et l'anneau adaptateur et dans la porte. La barre d'entraînement doit glisser sous le pêne dormant.

8

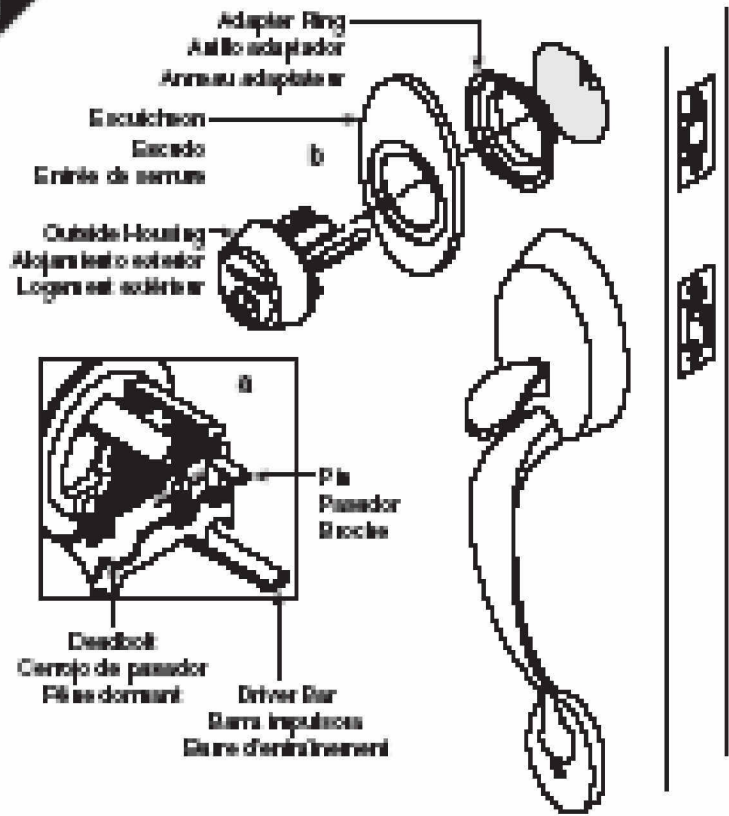



Architectural Testing, Inc

Test sample complies with details shown herein. Any deviations are noted in the test report or drawings.

Report #: E4545.01, .02

Date: 07/14/15 By: CB

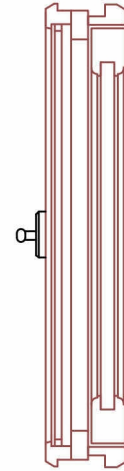
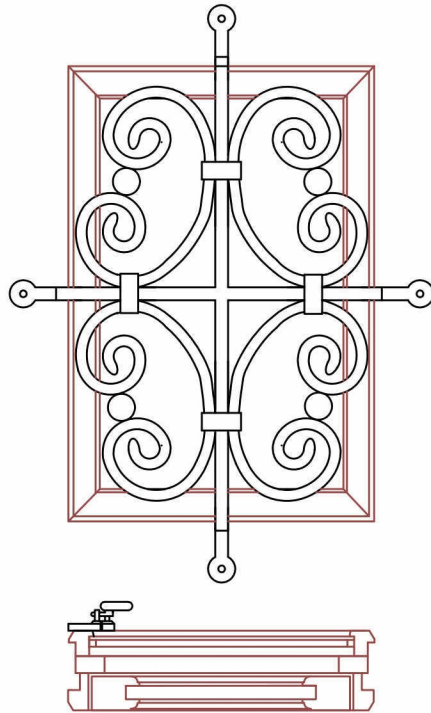

Speakeasy

Glass*Craft

Penrond 4"x4" 5/8" Radius Hinge

Install (2) 3" #8 Wood Screws Per Henge.

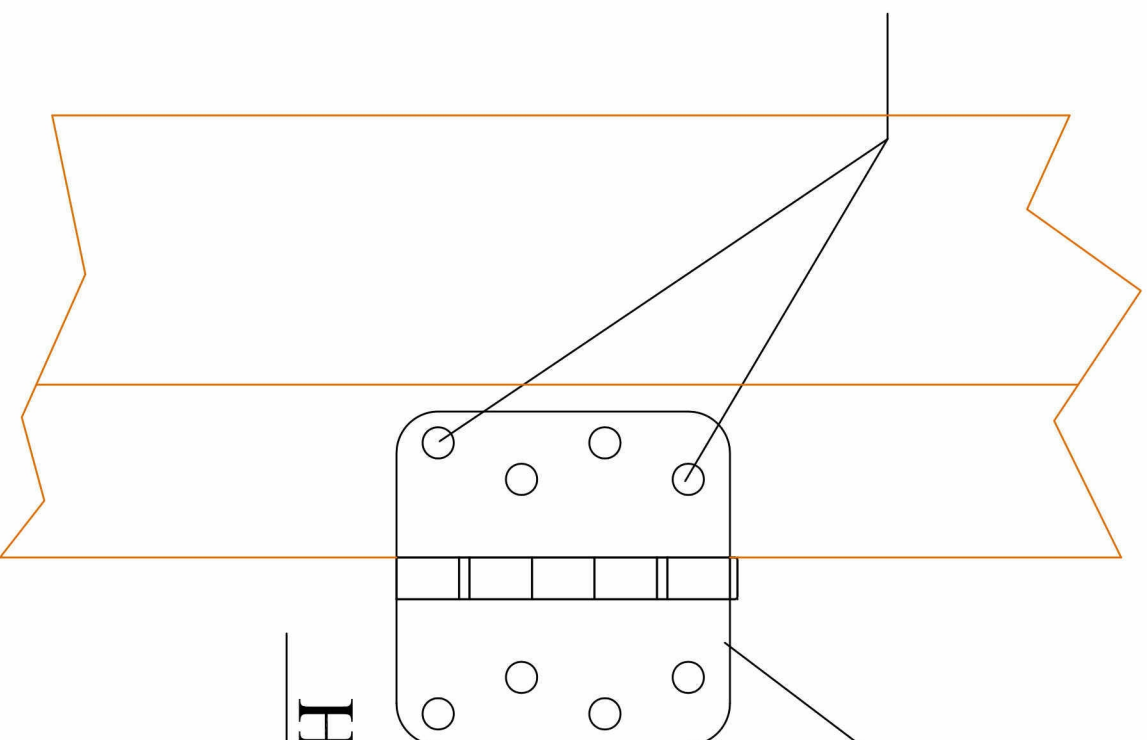

Architectural Testing, Inc
Test sample complies with details shown herein. Any deviations are noted in the test report or drawings.

Report #: E4545.01.02
Date: 07/14/15 By: CB

Hinge Detail

Glass*Craft
Impact Single 8'0 Fiberglass Door
/ Speakeasy Door

List of Material

Item #	Description	Material
1	Masonry	CONC.
2	2x Buck	Wood
3	Imperial 3 point lock set	Metal
4	Penrond 4"x4" 5/8" Radius Hinge	Metal
5	Endura Sill ZAIL 5866 / I/S	Alum.
6	3" #9 Wood screw	Metal
7	Door Jam	Fiber
8	Bottom Door sweep	Rubber
9	weather strip	Foam
10	Endura Sill ZAIL 5866 / O/S	Alum.
11	Door Fill	Foam
12	Stile	Composites
14	Impact speakeasy grill	Metal

Impact Single 8'0 Fiberglass Door / Speakeasy Door

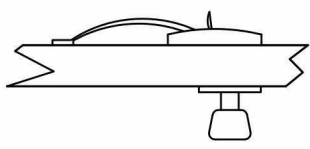

Imperial 3 point set 3

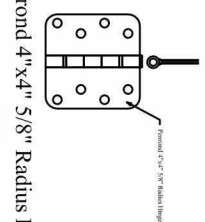

Penrond 4"x4" 5/8" Radius Hinge 4

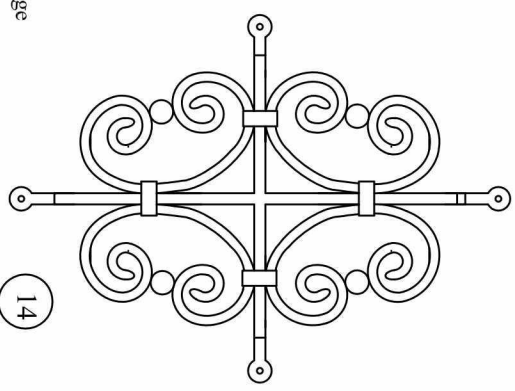

14



Bottom Door sweep 8

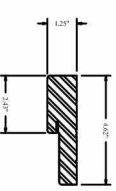

Door Jam 7



Endura Sill ZAIL 5866 / I/S 10



weather strip 9



Architectural Testing, Inc
 Test sample complies with details shown herein. Any deviations are noted in the test report or drawings.

Report #: E4545.01.02
 Date: 07/14/15 By: CB

Glass*Craft

Exterior

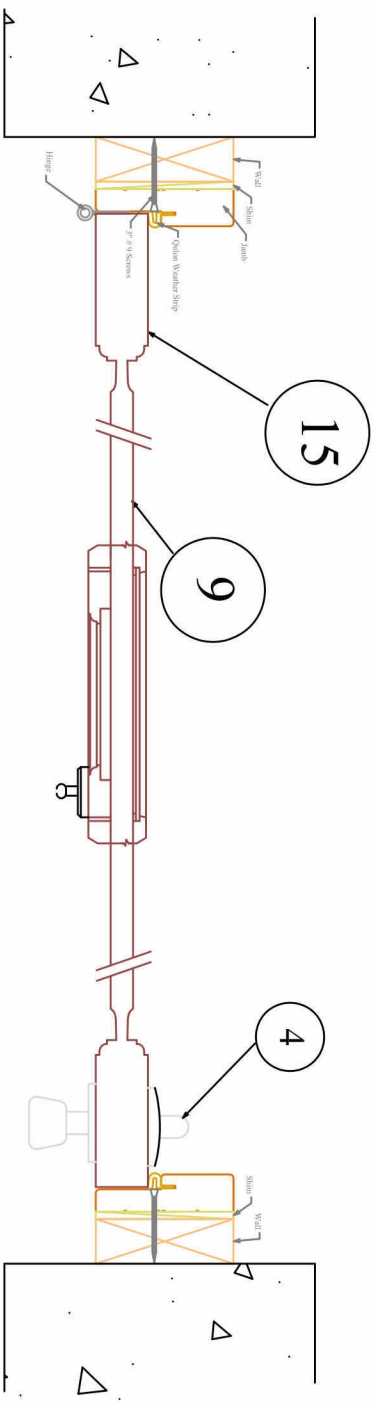

Interior

Horizontal Cross Section

Architectural Testing, Inc
Test sample complies with
details shown herein. Any
deviations are noted in the
test report or drawings.

Report #: E4545.01.02
Date: 07/14/15 By: CB

Impact Single 8'0 Fiberglass Door / Speakeasy Door Glass* Craft



Architectural Testing, Inc
Test sample complies with
details shown herein. Any
deviations are noted in the
test report or drawings.

Report #: E4545.01, .02

Date: 07/14/15 By: CB

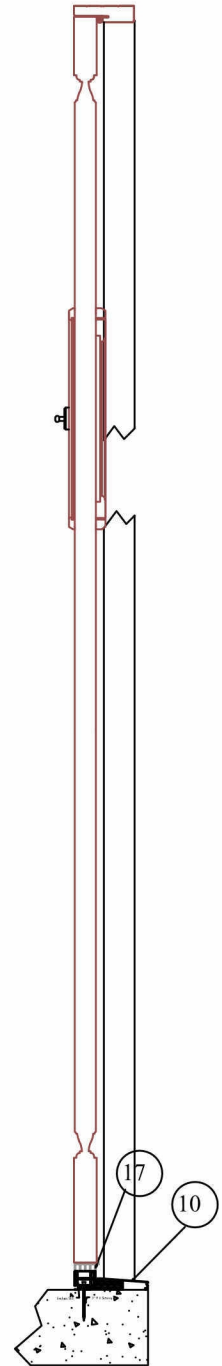
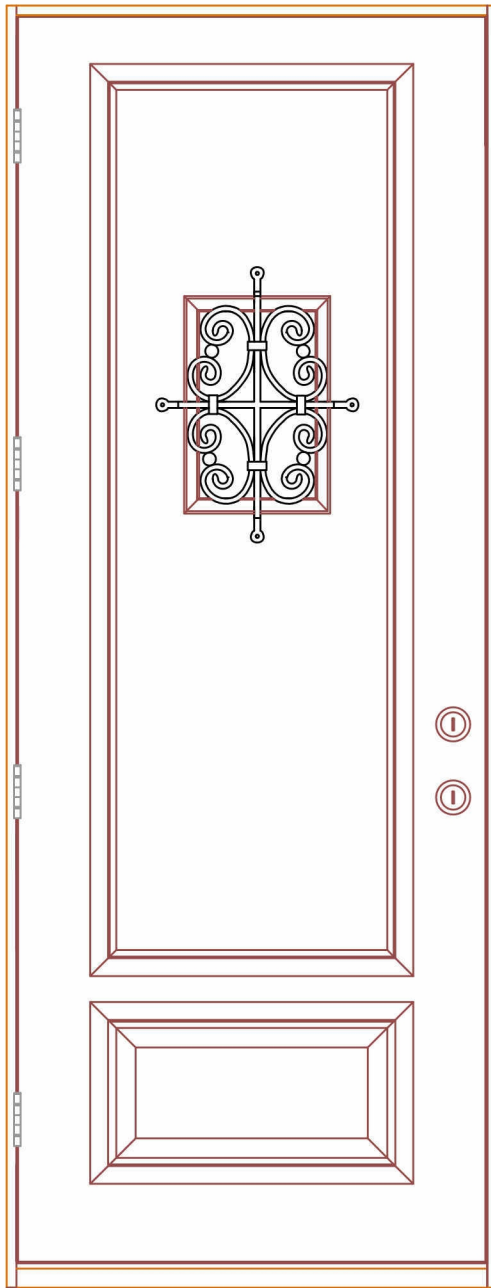

Section
H-H

Glass*Craft

Impact Single 8'0 Fiberglass Door
/ Speakeasy Door

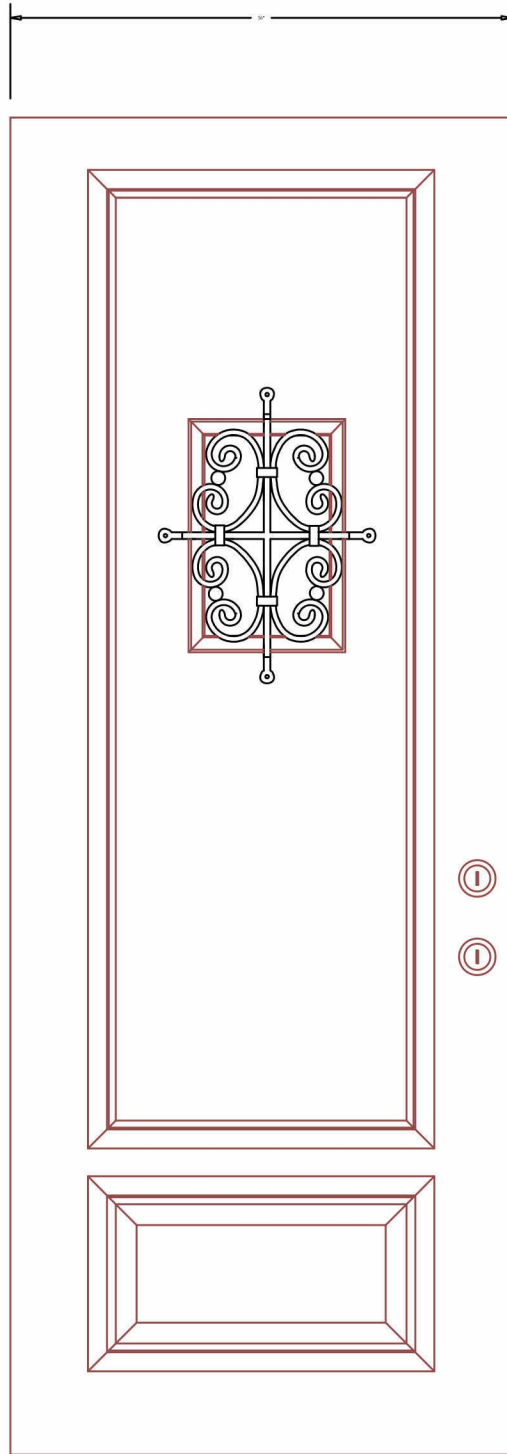

Architectural Testing, Inc

Test sample complies with details shown herein. Any deviations are noted in the test report or drawings.

Report #: E4545-01, -02

Date: 07/14/15 By: CB

Glass*Craft

ImpactSingle 8'0 Impact Fiberglass Door
/ Speakeasy Door

See Hinge Detail

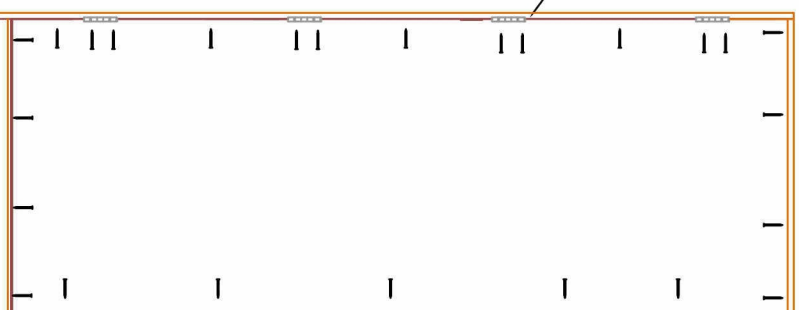

Architectural Testing, Inc
Test sample complies with
details shown herein. Any
deviations are noted in the
test report or drawings.

Report #: F4545_01_02

Date: 07/14/15

By: CB

ANCHORING LOCATION

Glass*Craft

Impact Single 8'0 Fiberglass Door / Speakeasy Door