



DEPARTMENT OF REGULATORY AND ECONOMIC RESOURCES (RER)  
BOARD AND CODE ADMINISTRATION DIVISION

**NOTICE OF ACCEPTANCE (NOA)**

MIAMI-DADE COUNTY  
PRODUCT CONTROL SECTION

11805 SW 26 Street, Room 208  
Miami, Florida 33175-2474  
T (786) 315-2590 F (786) 315-2599

[www.miamidade.gov/economy](http://www.miamidade.gov/economy)

**Berridge Manufacturing Company**  
**6515 Fratt Road**  
**San Antonio, TX 78218**

**SCOPE:**

This NOA is being issued under the applicable rules and regulations governing the use of construction materials. The documentation submitted has been reviewed and accepted by Miami-Dade County RER-Product Control Section to be used in Miami Dade County and other areas where allowed by the Authority Having Jurisdiction (AHJ).

This NOA shall not be valid after the expiration date stated below. The Miami-Dade County Product Control Section (In Miami Dade County) and/or the AHJ (in areas other than Miami Dade County) reserve the right to have this product or material tested for quality assurance purposes. If this product or material fails to perform in the accepted manner, the manufacturer will incur the expense of such testing and the AHJ may immediately revoke, modify, or suspend the use of such product or material within their jurisdiction. RER reserves the right to revoke this acceptance if it is determined by Miami-Dade County Product Control Section that this product or material fails to meet the requirements of the applicable building code.

This product is approved as described herein and has been designed to comply with the Florida Building Code, including the High Velocity Hurricane Zone.

**DESCRIPTION: Berridge “HR-16” Steel Wall & Soffit Panel System**

**APPROVAL DOCUMENT:** Engineering Report No. **20-227-HR16-ER**, titled “Berridge “HR-16” Steel Wall & Soffit Panel”, sheets 1 through 9 of 9, dated 09/24/2020, prepared by C-Buck Engineering, signed and sealed by James L. Buckner, P.E., bearing the Miami-Dade County Product Control revision stamp with the Notice of Acceptance number and expiration date by the Miami-Dade County Product Control Section.

**MISSILE IMPACT RATING: Large and Small Missile Impact Resistant**

**LABELING:** Each panel shall bear a permanent label with the manufacturer's name or logo, Houston, San Antonio or Seguin, TX, model/series, and following statement: "Miami-Dade County Product Control Approved", unless otherwise noted herein.

**LIMITATION:** This panel system has not been tested for water and air infiltration.

**RENEWAL** of this NOA shall be considered after a renewal application has been filed and there has been no change in the applicable building code negatively affecting the performance of this product.

**TERMINATION** of this NOA will occur after the expiration date or if there has been a revision or change in the materials, use, and/or manufacture of the product or process. Misuse of this NOA as an endorsement of any product, for sales, advertising or any other purposes shall automatically terminate this NOA. Failure to comply with any section of this NOA shall be cause for termination and removal of NOA.

**ADVERTISEMENT:** The NOA number preceded by the words Miami-Dade County, Florida, and followed by the expiration date may be displayed in advertising literature. If any portion of the NOA is displayed, then it shall be done in its entirety.

**INSPECTION:** A copy of this entire NOA shall be provided to the user by the manufacturer or its distributors and shall be available for inspection at the job site at the request of the Building Official.

This NOA **revises NOA # 20-0128.05** and consists of this page 1 and evidence pages E-1, E-2 and E-3, as well as approval document mentioned above.

The submitted documentation was reviewed by **Carlos M. Utrera, P.E.**



**NOA No. 20-1013.12**  
**Expiration Date: March 24, 2025**  
**Approval Date: January 21, 2021**  
Page 1

**NOTICE OF ACCEPTANCE: EVIDENCE SUBMITTED**

**1. Evidence submitted under previous NOA's**

**A. DRAWINGS “Submitted under NOA # 15-0421.13”**

1. Engineering Report No. **09-192-HR16-ER.3**, titled “Berridge “HR-16” Steel Wall & Soffit Panel”, sheets 1 through 9 of 9, dated 02/09/2010, with revision 2 dated 04/16/2015, prepared by C-Buck Engineering, signed and sealed by James L. Buckner, P.E.

**B. TESTS “Submitted under NOA # 09-1028.07”**

1. Test reports on 1) Uniform Static Air Pressure Test, Loading per FBC TAS 202-94  
2) Large Missile Impact Test per FBC, TAS 201-94  
3) Cyclic Wind Pressure Loading per FBC, TAS 203-94  
4) Tensile Test per ASTM E8-08  
along with marked-up drawings and installation diagram of three HR-16 Steel Siding/Soffit Panels, prepared by Architectural Testing, Inc., Test Report No. **78918.02-801-18**, dated 08/20/2009, signed and sealed by Joseph A. Reed, P.E.

**C. CALCULATIONS “Submitted under NOA # 09-1028.07”**

1. Fastener evaluation calculations, prepared by C-Buck Engineering, dated 10/22/2009, signed and sealed by James L. Buckner, P.E.

**D. QUALITY ASSURANCE**

1. Miami-Dade Department of Regulatory and Economic Resources (RER)

**E. MATERIAL CERTIFICATIONS**

1. None.

**F. STATEMENTS “Submitted under NOA # 15-0421.13”**

1. Drawing No. **09-192-HR16-ER.3** statement of code conformance to the 5<sup>th</sup> edition (2014) FBC issued by C-Buck Engineering, dated 02/09/2012, with revision 2 dated 04/16/2015, signed and sealed by James L. Buckner, P.E.

**“Submitted under NOA # 12-0329.10”**

2. Drawing No. **09-192-2** statement of code conformance to 2010 FBC issued by C-Buck Engineering, dated 02/29/2012, signed and sealed by James L. Buckner, P.E.

**“Submitted under NOA # 09-1028.07”**

3. Statement letter of no financial interest issued by C-Buck Engineering, dated 10/23/2009, signed and sealed by James L. Buckner, P.E.



---

**Carlos M. Utrera, P.E.**  
**Product Control Examiner**  
**NOA No. 20-1013.12**  
**Expiration Date: March 24, 2025**  
**Approval Date: January 21, 2021**

**NOTICE OF ACCEPTANCE: EVIDENCE SUBMITTED**

**2. Evidence submitted under NOA #17-1211.14**

**A. DRAWINGS**

1. Engineering Report No. **17-128-HR16-ER**, titled “Berridge “HR-16” Steel Wall & Soffit Panel”, sheets 1 through 9 of 9, dated 11/13/2017, prepared by C-Buck Engineering, signed and sealed by James L. Buckner, P.E.

**B. TESTS**

1. None.

**C. CALCULATIONS**

1. None.

**D. QUALITY ASSURANCE**

1. Miami-Dade Department of Regulatory and Economic Resources (RER)

**E. MATERIAL CERTIFICATIONS**

1. None.

**F. STATEMENTS**

1. Statements of code conformance on drawing No. **17-128-HR16-ER**, Section 2.1.1 and 9.1, stating conformance to the 6<sup>th</sup> edition (2017) FBC issued by C-Buck Engineering, dated 11/13/2017, signed and sealed by James L. Buckner, P.E.



---

**Carlos M. Utrera, P.E.**  
**Product Control Examiner**  
**NOA No. 20-1013.12**  
**Expiration Date: March 24, 2025**  
**Approval Date: January 21, 2021**

**NOTICE OF ACCEPTANCE: EVIDENCE SUBMITTED**

**3. New evidence submitted**

**A. DRAWINGS**

1. Engineering Report No. **20-227-HR16-ER**, titled “Berridge “HR-16” Steel Wall & Soffit Panel”, sheets 1 through 9 of 9, dated 09/24/2020, prepared by C-Buck Engineering, signed and sealed by James L. Buckner, P.E.

**B. TESTS**

1. None.

**C. CALCULATIONS**

1. None.

**D. QUALITY ASSURANCE**

1. Miami-Dade Department of Regulatory and Economic Resources (RER)

**E. MATERIAL CERTIFICATIONS**

1. None.

**F. STATEMENTS**

1. Statements of code conformance on drawing No. **20-227-LPanel-ER**, Section 2.1.1 and 9.1, stating conformance to the 7<sup>th</sup> edition (2020) FBC issued by C-Buck Engineering, dated 09/24/2020, signed and sealed by James L. Buckner, P.E.



---

**Carlos M. Utrera, P.E.**  
**Product Control Examiner**  
**NOA No. 20-1013.12**  
**Expiration Date: March 24, 2025**  
**Approval Date: January 21, 2021**

**Engineering Report & Drawings**  
of  
**Berridge Manufacturing Company**  
**"HR-16"**  
**Wall & Soffit Panel Assembly**  
for  
**Miami-Dade Notice of Acceptance (N.O.A.)**

**Category: Panels**  
**Sub - Category: Wall**

Product: "HR-16" Structural Steel Wall Panel  
Material: Steel  
Panel Thickness: 24 gauge

**Prepared by:**  
**James L. Buckner, P.E.**  
Florida Professional Engineer # 31242  
Project Manager: Diana Galloway  
Report No.: 20-227-HR16-ER  
Date: 9/24/2020

Contents:

Cover Page	Page 1
Product Details	Page 2
Performance/Installation	Page 3
Limitations/Reference Data	Page 4
Product Components	Page 5
Product Drawings & Details	Page 6-9

**PRODUCT REVISED**  
as complying with the Florida  
Building Code  
**NOA-No.** 20-1013.12  
**Expiration Date** 03/24/2025  
By   
**Miami-Dade Product Control**

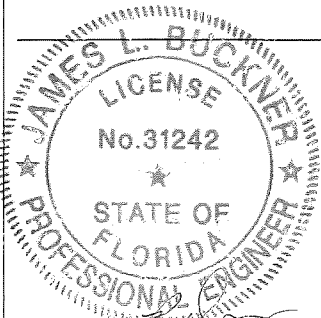

**BERRIDGE "HR-16" STEEL WALL & SOFFIT PANEL  
ENGINEERING REPORT**

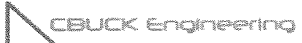
 Specialty Structural Engineering <b>CBUCK, Inc.</b> COA #8064 1374 Community Drive Jupiter, FL 33458 (561) 491-9927	<b>MANUFACTURER:</b>	<b>DATE:</b>	9/24/2020
	<b>Berridge Manufacturing Company</b> 6515 Fratt Rd. San Antonio, TX 78218	<b>PAGE #:</b>	1 OF 9
		<b>REPORT #:</b>	20-227-HR16-ER
		<b>REVISES #:</b>	17-128-HR16-ER
		<b>DRAWN BY:</b>	DG
		<b>REVISIONS:</b>	2/9/12,4/16/15,11/13/17,9/24/20

**1.0 Product:**

- 1.1 **Manufacturer:** Berridge Manufacturing Company
- 1.2 **Product Name:** "HR-16" Structural Steel Wall & Soffit Panel
- 1.3 **Category:** Panels
- 1.4 **Subcategory:** Wall

**2.0 Evaluation Scope:**

**2.1 Evaluation Criteria:**

- 2.1.1 Florida Building Code (FBC) 7th Edition (2020)
  - 2.1.1.1 Code Section: High Velocity Hurricane Zone (HVHZ)
  - 2.1.1.2 Miami-Dade Department Of Regulatory And Economic Resources, Product Control Section Checklist # 0250

**2.2 Properties Evaluated:**

- 2.2.1 Wind Resistance Properties
  - 2.2.1.1 Uniform Static Air Pressure  
(Structural only. This panel system has not been tested for water & air infiltration.)
  - 2.2.1.2 Cyclic Wind Pressure
  - 2.2.1.3 Large Missile Impact
- 2.2.2 Material Properties
  - 2.2.2.1 Tensile strength

**2.3 Limits of Evaluation:**

This product is limited to compliance with the criteria in section 2.1 and properties in section 2.2 of this report.

**3.0 Evaluated Uses:**

"HR-16" Wall panels are evaluated for use as exterior wall or soffit panels.

**4.0 Product Description:**

**4.1 General:**

"HR-16" panels are structural steel wall panels with concealed fasteners, a flush seam appearance and an interlocking seam edge. Panels are installed horizontally to vertical steel supports with screws.

**4.2 Product Dimensions:**

- 4.2.1 Thickness: 24 gauge
- 4.2.2 Coverage Width: 16 in.
- 4.2.3 Rib height: 7/8 in.
- 4.2.4 Length: Roll formed, continuous up to 40 ft.

**PRODUCT REVISED**  
 as complying with the Florida  
 Building Code  
 NOA-No. 20-1013.12  
 Expiration Date 03/24/2025  
 By [Signature]  
 Miami-Dade Product Control

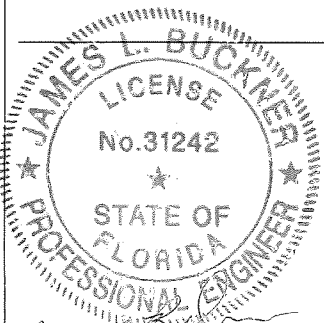

**BERRIDGE "HR-16" STEEL WALL & SOFFIT PANEL  
 ENGINEERING REPORT**

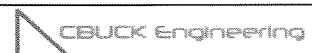
 Specialty Structural Engineering CBUCK, Inc. COA #8064 1374 Community Drive Jupiter, FL 33458 (561) 491-9927	<b>MANUFACTURER:</b>	<b>DATE:</b>	9/24/2020
	Berridge Manufacturing Company	<b>PAGE #:</b>	2 OF 9
	6515 Fratt Rd.	<b>REPORT #:</b>	20-227-HR16-ER
	San Antonio, TX 78218	<b>REVISES #:</b>	17-128-HR16-ER
		<b>DRAWN BY:</b>	DG
	<b>REVISIONS:</b>	2/9/12,4/16/15,11/13/17,9/24/20	

**5.0 Support:**

The Support assembly is designed by others and shall have the following minimum Characteristics:

- 5.1 Type: Girts
- 5.2 Material: Steel
- 5.3 Thickness: 16 Gauge min.
- 5.4 Yield Strength: 50 ksi
- 5.5 Girt Size: 2" min. flange bearing

**6.0 Performance:**

**6.1 Wind Resistance:**

- Design Pressure: **Positive + 65 psf**  
**Negative - 115 psf**

Based on the following conditions:

**6.1.1 Support:**

- 6.1.1.1 Type: Vertical Girts
  - 6.1.1.2 Shape: Cee
  - 6.1.1.3 Dimensions: 4" x 2-1/2"
  - 6.1.1.4 Material: Steel
  - 6.1.1.5 Thickness: 16 Ga.
  - 6.1.1.6 Yield Strength: 50 ksi
  - 6.1.1.7 Spacing: 24" o.c.
  - 6.1.1.8 Span Condition: 4 or more
- 6.1.2 Attachment of "HR-16" panel per Section 7.0

**6.2 Uniform Static Air Infiltration:**

- Standard: TAS 202
- Results: Per Section 6.1

**6.3 Cyclic Wind Loading:**

- Standard: TAS 203
- Results: Passed

**6.4 Impact Rating: Large Missile Impact**

- Standard: TAS 201
- Results: Passed

**PRODUCT REVISED**  
as complying with the Florida Building Code

**NOA-No.** 20-1013.12

**Expiration Date** 03/24/2025

By   
**Miami-Dade Product Control**

**7.0 Installation:**

Install per the following:

"HR-16" wall panel to supports:

Two screws per Section 12.2.1, located at the horizontal joints to the vertical supports (every 24 in.) and at every panel end (every 16 in.) Fasteners shall penetrate the steel supports by 1/2 in. minimum.

See Drawings on pages 6 through 9 of this report. Refer to manufacturer's installation instructions as a supplemental guide for attachment.

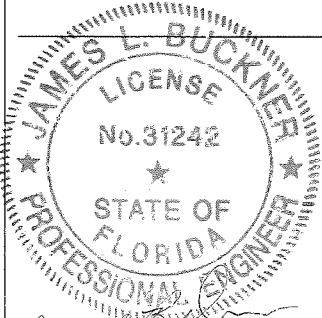

**BERRIDGE "HR-16" STEEL WALL & SOFFIT PANEL  
ENGINEERING REPORT**

  
Specialty Structural Engineering  
CBUCK, Inc. COA #8064  
1374 Community Drive  
Jupiter, FL 33458  
(561) 491-9927

**MANUFACTURER:**  
Berridge Manufacturing  
Company  
6515 Fratt Rd.  
San Antonio, TX 78218

DATE:	9/24/2020
PAGE #:	3 OF 9
REPORT #:	20-227-HR16-ER
REVISES #:	17-128-HR16-ER
DRAWN BY:	DG
REVISIONS:	2/9/12,4/16/15,11/13/17,9/24/20

Date: 9/24/20

**8.0 Limitations of Use:**

- 8.1 Performance data is based on minimum characteristics per Section 6.1.1.
- 8.2 Design of support system is outside the scope of this report. Support shall be structural framing members complying with the Miami-Dade (Florida High velocity zone) code and shall be designed by others.
- 8.3 Panel shall not be used as axial load bearing components and shall not be intended / designed to act as a diaphragm.
- 8.4 This evaluation is limited to the wall panel, wall panel fasteners and its attachment to the supports. The structural properties and design of all other items are outside the scope of this evaluation and should be submitted to the permitting jurisdiction for review and approval.

**9.0 Code Compliance:**

- 9.1 Product meets the High Velocity Hurricane Zone (HVHZ) Requirements of the Florida Building Code (FBC) 7th Edition (2020) for the properties evaluated.

**10.0 Identification:**

- 10.1 Each Panel shall bear a permanent one of the following permanent labels:

Berridge Manufacturing Co.	Berridge Manufacturing Co.	Berridge Manufacturing Co.
1720 Maury Street	6515 Fratt Road	2201 Rudeloff Road
Houston, TX 77026	San Antonio, TX 78218	Seguin, TX 78155

And the Statement: "Miami-Dade County Product Control Approved".

- 10.2 Labeling shall comply with FBC 7th Edition (2020), Section 1709.10.

**PRODUCT REVISED**  
**as complying with the Florida**  
**Building Code**  
**NOA-No.** 20-1013.12  
**Expiration Date** 03/24/2025  
**By**   
**Miami-Dade Product Control**

**11.0 Referenced Data:**

- 11.1 Test Report on:  
 TAS 201-94, Impact Test Procedures  
 TAS 202-94, Criteria for Testing Impact and Non-impact Resistant Building Envelope Components Using Uniform Static Air Pressure  
 TAS 203-94, Criteria for Testing Products Subject to Cyclic Wind Pressure Loading  
 ASTM E8-08, Standard Test Methods for Tensile Testing of Metallic Materials  
 For: "HR-16" Panel  
 By: Architectural Testing, Inc., Southlake, TX  
 Report No.: 78918-02-801-18, Dated: 8/20/09. Signed & Sealed 8/24/09 by Joseph A. Reed, P.E.

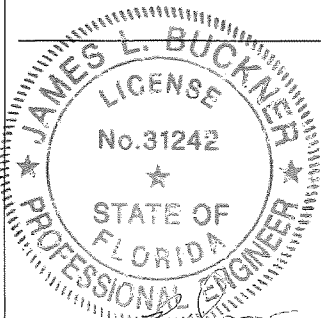

**BERRIDGE "HR-16" STEEL WALL & SOFFIT PANEL  
 ENGINEERING REPORT**

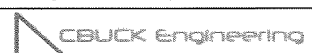
 Specialty Structural Engineering CBUCK, Inc. COA #8064 1374 Community Drive Jupiter, FL 33458 (561) 491-9927	<b>MANUFACTURER:</b>  Berridge Manufacturing Company 6515 Fratt Rd. San Antonio, TX 78218	DATE:	9/24/2020
		PAGE #:	4 OF 9
		REPORT #:	20-227-HR16-ER
		REVISES #:	17-128-HR16-ER
		DRAWN BY:	DG
		REVISIONS:	2/9/12,4/16/15,11/13/17,9/24/20



**12.0 Product Components:**

**12.1 "HR-16" Panel:**

**12.1.1 Dimensions:**

- 12.1.1.1 Panel Gauge: 24 gauge
- 12.1.1.2 Coverage Width: 16 in.
- 12.1.1.3 Rib height: 7/8 in.
- 12.1.1.4 Length: Roll formed, continuous up to 40 ft.

**12.1.2 Properties:**

- 12.1.2.1 Material: Steel
- 12.1.2.2 Yield Strength: 50 ksi
- 12.1.2.3 Thickness: 24 Gauge (t = 0.026" painted, as tested)
- 12.1.2.4 Corrosion Resistance/Standards:
  - 12.1.2.4.1 Galvanized G90 per ASTM A924
  - 12.1.2.4.2 Galvalume per ASTM A792 AZ 55 with Kynar 500

**12.2 Fasteners:**

**12.2.1 Panel to Support Fasteners**

- 12.2.1.1 Manufacturer: Generic
- 12.2.1.2 Type: Self Drilling Sheet Metal Screw
- 12.2.1.3 Size: #12 x 3/4"
- 12.2.1.4 Corrosion Resistance: Galvanized or Stainless Steel

**PRODUCT REVISED**  
as complying with the Florida  
Building Code

**NOA-No.** 20-1013.12

**Expiration Date** 03/24/2025

**By**   
**Miami-Dade Product Control**

**BERRIDGE "HR-16" STEEL WALL & SOFFIT PANEL  
ENGINEERING REPORT**

 **CBUCK Engineering**  
Specialty Structural Engineering  
CBUCK, Inc. COA #8064  
1374 Community Drive  
Jupiter, FL 33458  
(561) 491-9927

**MANUFACTURER:**  
Berridge Manufacturing  
Company  
6515 Fratt Rd.  
San Antonio, TX 78218

DATE:	9/24/2020
PAGE #:	5 OF 9
REPORT #:	20-227-HR16-ER
REVISES #:	17-128-HR16-ER
DRAWN BY:	DG
REVISIONS:	2/9/12,4/16/15,11/13/17,9/24/20

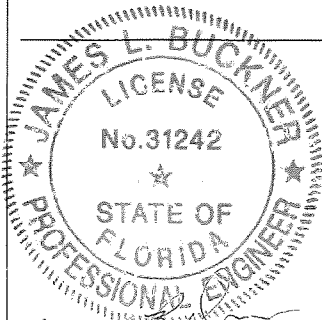

Date: 9/24/20

**BERRIDGE MANUFACTURING COMPANY**

**"HR-16" DRAWINGS**

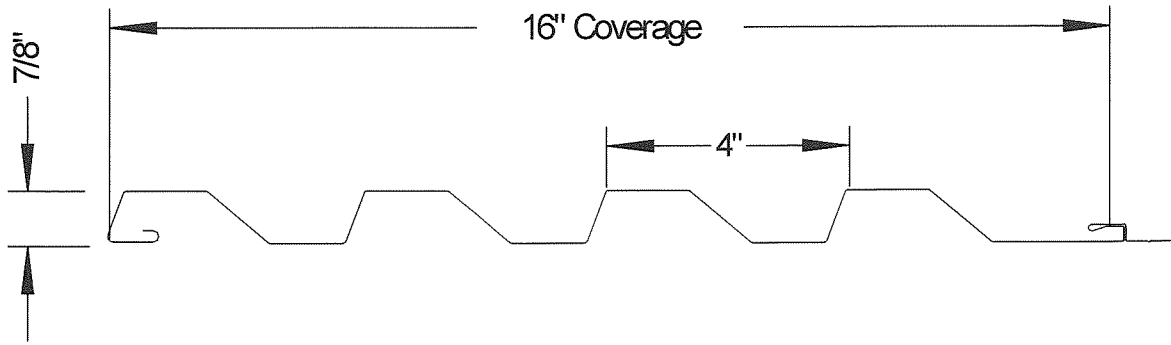

**TYPICAL PANEL PROFILE**

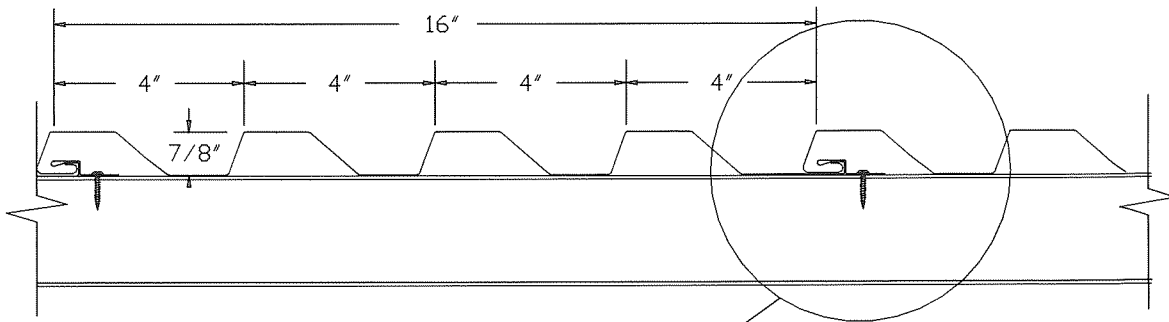

"HR-16"  
Wall Panel

Two #12 X 3/4"  
Self-Drilling Screws

Steel Support

**TYPICAL PANEL ASSEMBLY  
SECTION VIEW**

**PRODUCT REVISED**  
as complying with the Florida  
Building Code

**NOA-No.** 20-1013.12

**Expiration Date** 03/24/2025

By *R. Torres*  
**Miami-Dade Product Control**

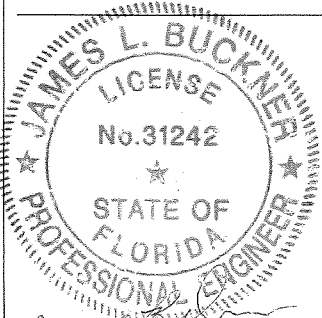

**BERRIDGE "HR-16" STEEL WALL & SOFFIT PANEL  
PROFILE & TYPICAL ASSEMBLY SECTION VIEW**

**CBUCK Engineering**  
Specialty Structural Engineering  
CBUCK, Inc. COA #8064  
1374 Community Drive  
Jupiter, FL 33458  
(561) 491-9927

**MANUFACTURER:**  
Berridge Manufacturing  
Company  
6515 Fratt Rd.  
San Antonio, TX 78218

DATE:	9/24/2020
PAGE #:	6 OF 9
REPORT #:	20-227-HR16-ER
REVISES #:	17-128-HR16-ER
DRAWN BY:	DG
REVISIONS:	2/9/12,4/16/15,11/13/17,9/24/20

Date: 9/24/20

BERRIDGE MANUFACTURING COMPANY

"HR-16" DRAWINGS

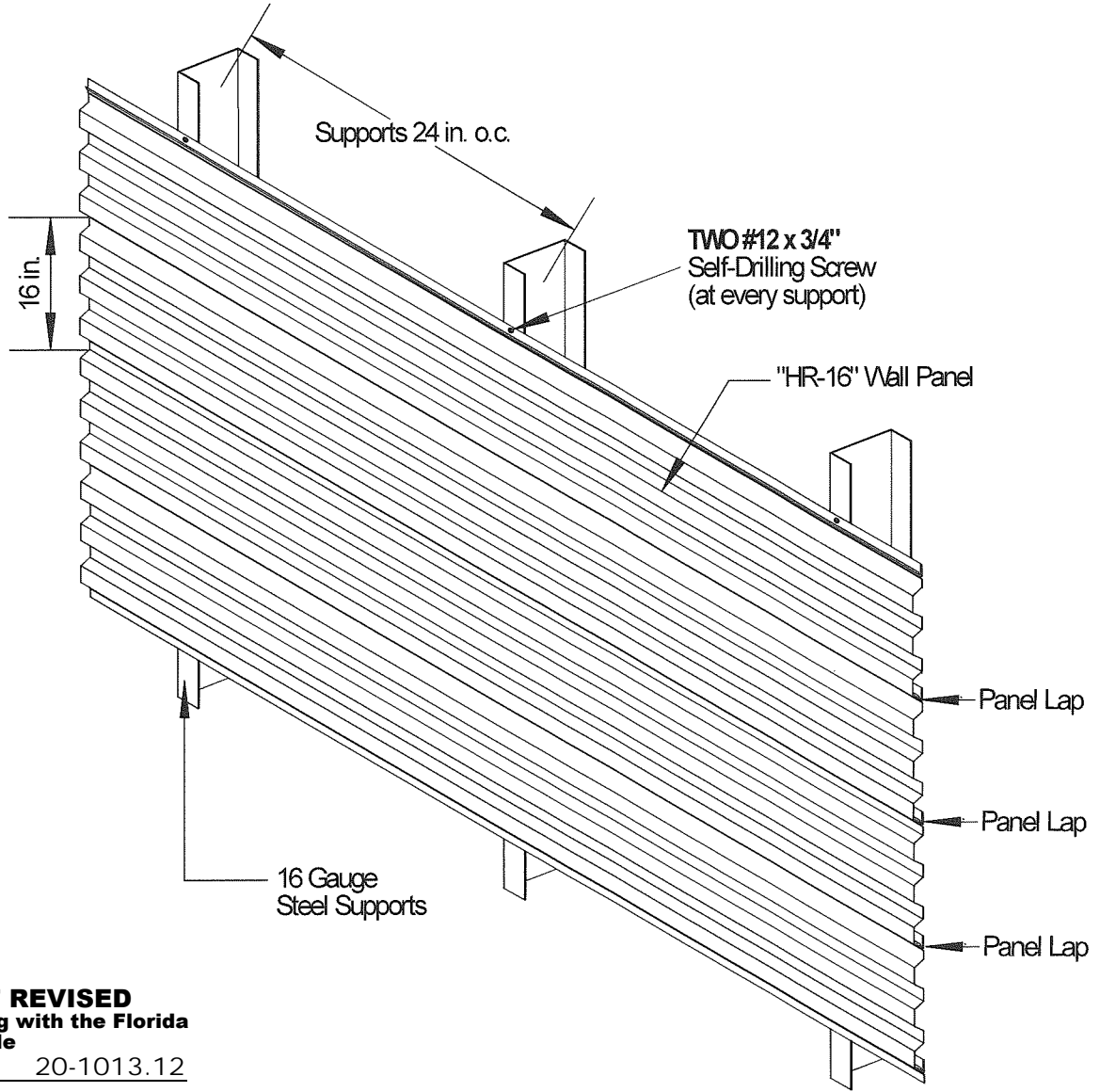

**PRODUCT REVISED**  
as complying with the Florida  
Building Code

NOA-No. 20-1013.12

Expiration Date 03/24/2025

By *[Signature]*  
Miami-Dade Product Control

TYPICAL ELEVATION VIEW  
OUTSIDE OF WALL ASSEMBLY

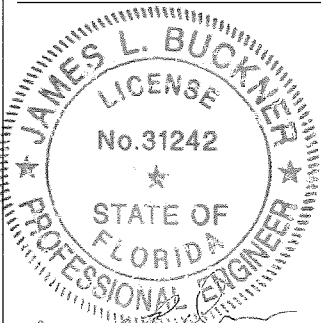

BERRIDGE "HR-16" STEEL WALL & SOFFIT PANEL  
TYPICAL ELEVATION VIEW

**CBUCK Engineering**  
Specialty Structural Engineering  
CBUCK, Inc. COA #8064  
1374 Community Drive  
Jupiter, FL 33458  
(561) 491-9927

MANUFACTURER:  
Berridge Manufacturing  
Company  
6515 Fratt Rd.  
San Antonio, TX 78218

DATE:	9/24/2020
PAGE #:	7 OF 9
REPORT #:	20-227-HR16-ER
REVISES #:	17-128-HR16-ER
DRAWN BY:	DG
REVISIONS:	2/9/12,4/16/15,11/13/17,9/24/20

Date: 9/24/20

# BERRIDGE MANUFACTURING COMPANY

## "HR-16" DRAWINGS

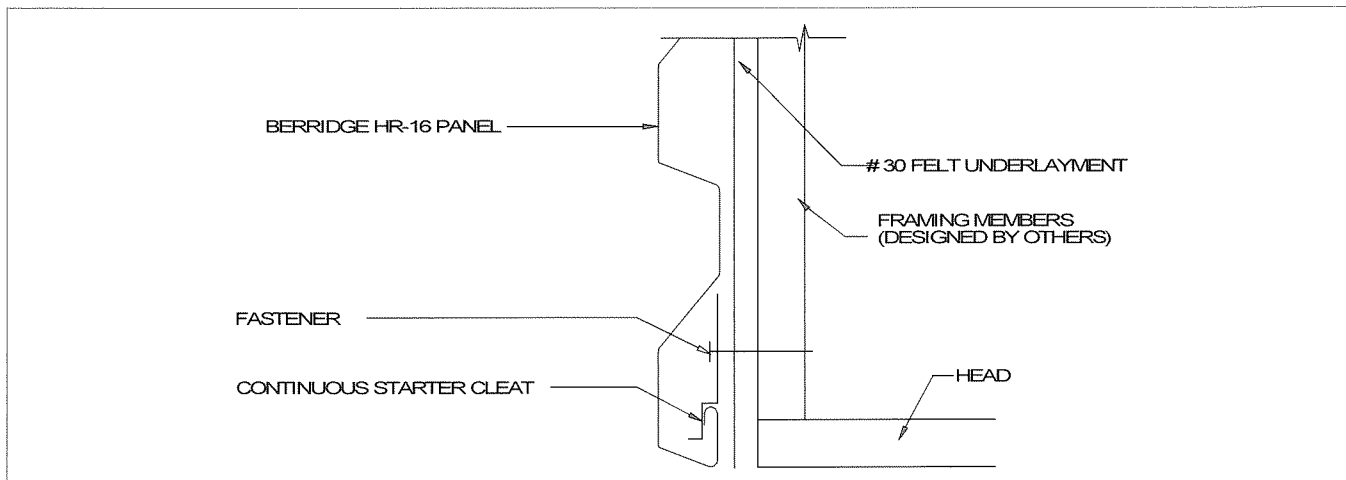

**TYPICAL HEADER DETAIL**

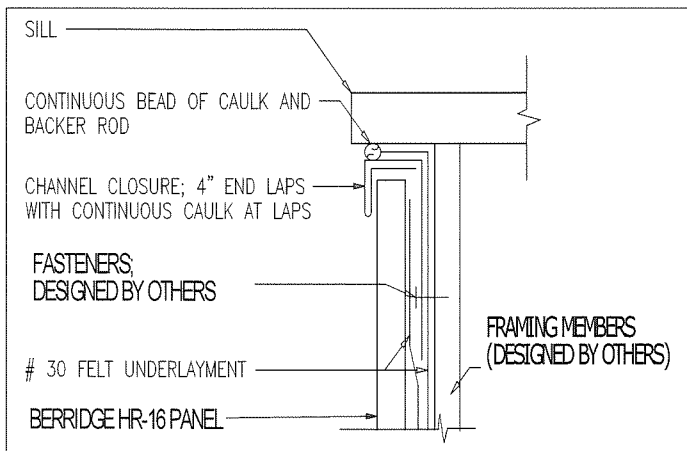

**TYPICAL SILL DETAIL**

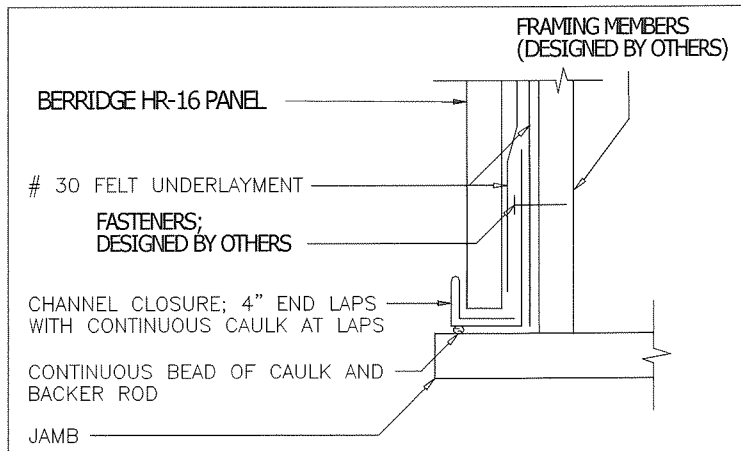

**TYPICAL JAMB DETAIL**

**PRODUCT REVISED**  
as complying with the Florida  
Building Code

**NOA-No.** 20-1013.12

**Expiration Date** 03/24/2025

By *[Signature]*  
**Miami-Dade Product Control**

**NOTES:**

1. SUPPLEMENTAL ATTACHMENT DETAILS DESIGNED BY OTHERS
2. REFER TO MANUFACTURER FOR FASTENER, CAULKING SPECIFICATIONS & SUPPLEMENTAL ATTACHMENT DETAILS

**BERRIDGE "HR-16" STEEL WALL & SOFFIT PANEL (SUPPLEMENTAL DETAILS)**  
TYPICAL HEADER, SILL & JAMB DETAILS

**CBUCK Engineering**  
Specialty Structural Engineering  
CBUCK, Inc. COA #8064  
1374 Community Drive  
Jupiter, FL 33458  
(561) 491-9927

**MANUFACTURER:**  
Berridge Manufacturing  
Company  
6515 Fratt Rd.  
San Antonio, TX 78218

DATE:	9/24/2020
PAGE #:	8 OF 9
REPORT #:	20-227-HR16-ER
REVISES #:	17-128-HR16-ER
DRAWN BY:	DG
REVISIONS:	2/9/12,4/16/15,11/13/17,9/24/20

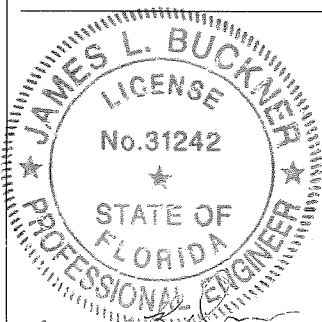

Date: 9/24/20

# BERRIDGE MANUFACTURING COMPANY

## "HR-16" DRAWINGS

**PRODUCT REVISED**  
 as complying with the Florida  
 Building Code  
 NOA-No. 20-1013.12  
 Expiration Date 03/24/2025  
 By [Signature]  
 Miami-Dade Product Control

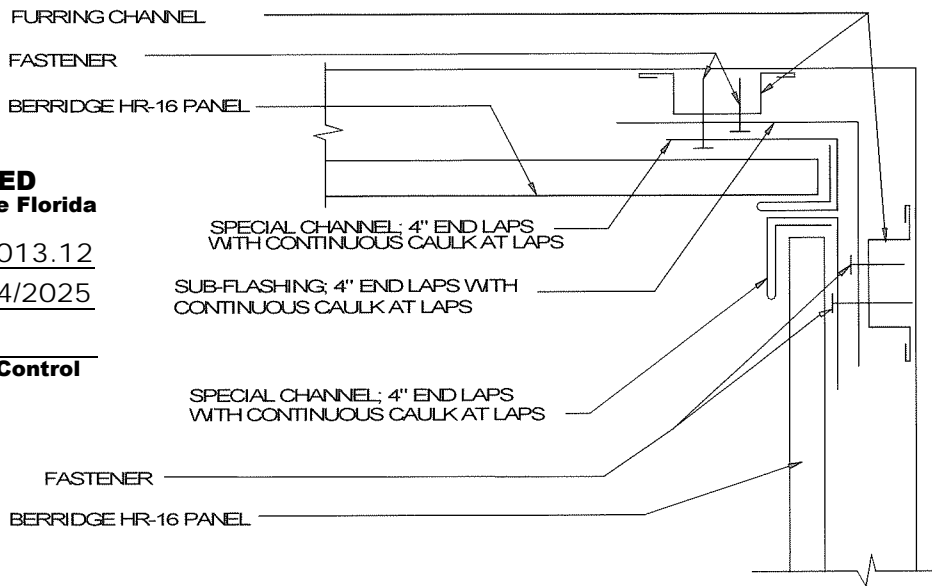

**TYPICAL INSIDE CORNER DETAIL**

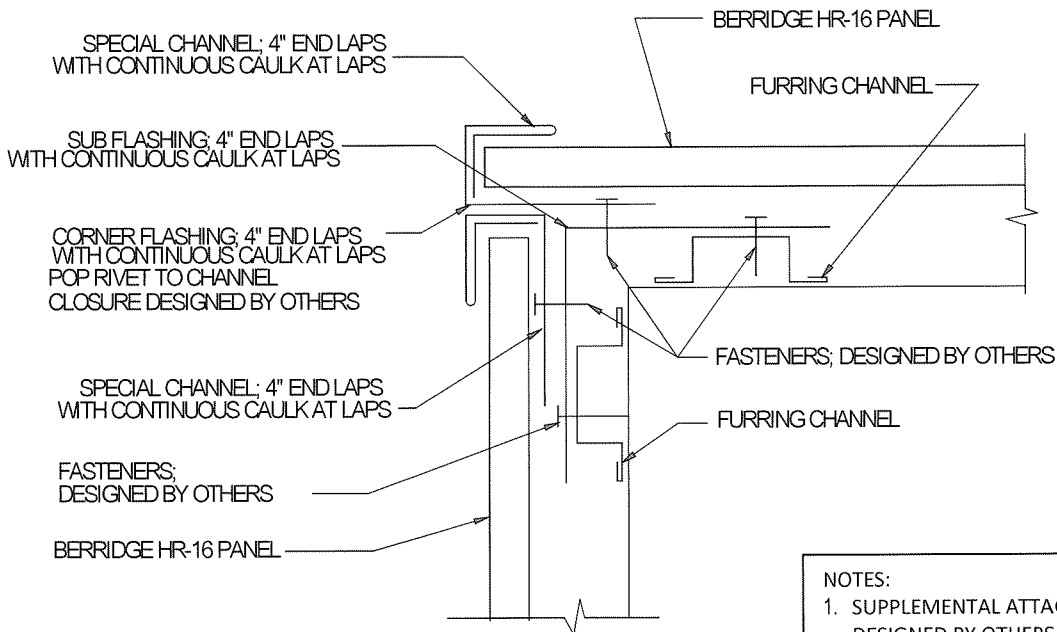

**TYPICAL OUTSIDE CORNER DETAIL**

- NOTES:
- SUPPLEMENTAL ATTACHMENT DETAILS DESIGNED BY OTHERS
  - REFER TO MANUFACTURER FOR FASTENER, CAULKING SPECIFICATIONS & SUPPLEMENTAL ATTACHMENT DETAILS

**BERRIDGE "HR-16" STEEL WALL & SOFFIT PANEL (SUPPLEMENTAL DETAILS)  
 TYPICAL INSIDE & OUTSIDE CORNER DETAILS**

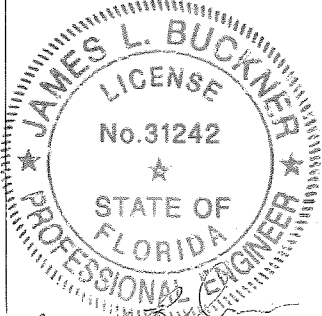

**CBUCK Engineering**  
 Specialty Structural Engineering  
 CBUCK, Inc. COA #8064  
 1374 Community Drive  
 Jupiter, FL 33458  
 (561) 491-9927

**MANUFACTURER:**  
 Berridge Manufacturing  
 Company  
 6515 Fratt Rd.  
 San Antonio, TX 78218

DATE:	9/24/2020
PAGE #:	9 OF 9
REPORT #:	20-227-HR16-ER
REVISES #:	17-128-HR16-ER
DRAWN BY:	DG
REVISIONS:	2/9/12,4/16/15,11/13/17,9/24/20

Date: 9/24/20