

Evaluation Report

“Zee-Lock Panel or Curved Zee-Lock Panel”

With Continuous Zee-Rib Clip

Metal Roof Assembly

Manufacturer:
Berridge Manufacturing Company
1720 Maury Road
Houston, TX 77026
(800) 231-8127

for

Florida Product Approval
FL 11159.3 R7
Florida Building Code 7th Edition (2020)

Method: 1 - D
Category: Roofing
Sub - Category: Metal Roofing

Product: “Zee-Lock” Roof Panel
Material: Steel
Panel Thickness: 22 gauge
Panel Width: 16”
Support: Steel Deck

Prepared by:

James L. Buckner, P.E., S.E.C.B.
Florida Professional Engineer # 31242
Florida Evaluation ANE ID: 1916
Project Manager: Diana Galloway
Report No. 20-227-162-ZL-S2S-ER
(Revises 19-162- ZL-S2S-ER, FL11159.3 R6)
Date: 09 / 17 / 20

Contents:

Evaluation Report Pages: 1 – 9

This item has been electronically signed and sealed by James L. Buckner, P.E., on this date using a Digital Signature. Printed copies of this document are not considered signed and sealed, and the signature must be verified on any electronic copies.

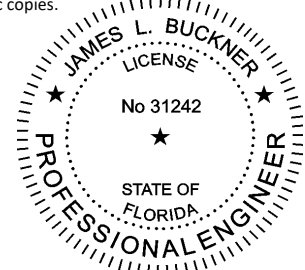

2020.10.15 19:45:20 -04'00'

Manufacturer:	Berridge Manufacturing Company 1720 Maury Road Houston, TX 77026 (800) 231-8127 www.berridge.com
Product Name:	“Zee-Lock” or “Curved Zee-Lock”
Product Category:	Roofing
Product Sub-Category	Metal Roofing
Compliance Method:	State Product Approval Rule 61G20-3.005 (1) (d)
Product/System Description:	“Zee-Lock” or “Curved Zee-Lock” Double Lock Standing Seam Roof Panel 2” Rib Height, 16” wide, 22 gauge Steel roof panel restrained by continuous “Zee-Rib” continuous panel clips, fastened into Steel Deck.
Product Assembly as Evaluated:	Refer to Page 4 of this report for product assembly components/materials & standards: <ol style="list-style-type: none">1. Roof Panel2. Panel Clip3. Fasteners4. Underlayment5. Insulation (Optional)
Support:	Type: Steel Deck (Design of steel deck and its attachment to support framing is outside the scope of this evaluation.) Description: <ul style="list-style-type: none">• 22 Gauge minimum• Yield Strength: 40 ksi minimum
Slope:	Minimum slope shall be in compliance with FBC Chapter 15 Section 1507.4.2, applicable code sections and in accordance with manufacturer’s recommendations.
Arched Min. Radius for Curved Panel:	20 Feet
Performance:	Wind Uplift Resistance: <ul style="list-style-type: none">• Design Uplift Pressure: Refer to Table “A” (Refer to “Table A” attachment details herein)

- Performance Standards:** The product described herein has demonstrated compliance with:
The product described herein has demonstrated compliance with:
- UL580-06 – *Test for Uplift Resistance of Roof Assemblies*
 - UL 1897-12 – *Uplift test for roof covering systems*
 - TAS 125-03 – *Standard Requirements for Metal Roofing Systems*
- Standards Equivalency:** The UL 580-94 & UL 1897-98 standard version used to test the evaluated product assembly is equivalent with the prescribed standards in UL 580-06 & UL 1897-12 adopted by the Florida Building Code 7th Edition (2020).
- Code Compliance:** The product described herein has demonstrated compliance with Florida Building Code 7th Edition (2020), Section 1504.3.2.
- Evaluation Report Scope:** This product evaluation is limited to compliance with the structural requirements of the Florida Building Code, as related to the scope section to Florida Product Approval Rule 61G20-3.001.
- Limitations and Conditions of Use:**
- Scope of “Limitations and Conditions of Use” for this evaluation:
This evaluation report for “Optional Statewide Approval” contains technical documentation, specifications and installation method(s) which include “Limitations and Conditions of Use” throughout the report in accordance with Rule 61G20-3.005. Per Rule 61G20-3.004, the Florida Building Commission is the authority to approve products under “Optional Statewide Approval”.
 - Option for application outside “Limitations and Conditions of Use”
Rule 61G20-3.005(1)(e) allows engineering analysis for “project specific approval by the local authorities having jurisdiction in accordance with the alternate methods and materials authorized in the Code”. Any modification of the product as evaluated in this report and approved by the Florida Building Commission is outside the scope of this evaluation and will be the responsibility of others.
 - This report is a building code product evaluation per FLPE rule (FAC) 61G15-36 to comply with Florida product approval rule (FAC) 61G20-3. This evaluation report is part of the Florida Building Commission approval for the listed code related criteria. This report by James Buckner, P.E. and CBUG Engineering is not a design certification of code compliance construction submittal documentation, per FBC section 107, for any individual structure, site specific or permit design.
 - All metal components and fasteners shall be corrosion resistant in accordance with applicable sections of FBC, including but limited to Sections 1504.3.2, 1506.6 and 1507.4.4.
 - Design of support system is outside the scope of this report.
 - Fire Classification is outside the scope of Rule 61G20-3, and is therefore not included in this evaluation.
 - This evaluation report does not evaluate the use of this product for use in the High Velocity Hurricane Zone code section. (Dade & Broward Counties)
- Quality Assurance:** The manufacturer has demonstrated compliance of roof panel products in accordance with the Florida Building Code and Rule 61G20-3.0005 (3) for manufacturing under a quality assurance program audited by an approved quality assurance entity through UL, LLC (FBC Organization #: QUA 9625).

**Components/Materials
(by Manufacturer):**

Roof Panel: Berridge "Zee-Lock"
Material: Steel
Thickness: 22 gauge (min.)
Panel Width: 16" (max.) Coverage
Rib Height: 2"
Yield Strength: 40 ksi min.
Steel Grade: 40
Corrosion Resistance: In compliance with FBC Section 1507.4.3:

- ASTM A792 coated, or
- ASTM A653 G90 galvanized steel

Roof Panel Clip: Berridge "Zee-Rib"
Type: One-Piece, continuous fixed clip
Material: Steel
Thickness: 24 Gauge
Yield Strength: 2"(tall) x 1-3/8"(wide) x continuous (w/panel length)
Dimensions: 40 ksi min.
Corrosion Resistance: Per FBC Section 1506.7

Fasteners:
Type: Low Profile Self-Drilling Self-Tapping Screw
Size : #14 – 13 x 9"
Corrosion Resistance: Per FBC Section 1506.6 and 1507.4.4
Standard: Per FBC Section 1506.6

Underlayment:
Material and application shall be in compliance with FBC Section 1507.1.1 and in accordance with applicable code sections and manufacturer's recommendations.

**Components& Materials:
(by Others)**

Insulation:
Type: Rigid Insulation Board
Thickness: 4" - 6" (max.)
Properties:
Density: 2.25 pcf (lbs/ft³) min.
Or Compressive Strength: 20 psi min.

Insulation Notes:

- Rigid Insulation shall meet minimum density OR compressive strength.
- Insulation shall comply with FBC Section 1508. When insulation is incorporated, fastener length shall conform to penetrate thru bottom of support a minimum of 3/4".

Installation:

Installation Method:

(Refer to "TABLE A" below and drawings at the end of this report.)

- Fastener Spacing Along Continuous Clip: **Refer to "TABLE A" Below** (along the length of the panel)
- Rib Interlock: **Refer to "TABLE A" Below**
Mechanically seamed 90° (SINGLE-LOCK) OR 180° (DOUBLE-LOCK)
- Assemblies with insulation include 3" steel disk per sheet.
- Minimum fastener penetration thru bottom of support, 3/4". (through bottom flute of steel deck)
- For panel construction at the end of panels, refer to manufacturer's instructions and any site-specific design.

TABLE "A"					
"Zee-Lock" (22 gauge Steel) Roof Panel attached to Steel Deck					
ALLOWABLE LOADS					
	Fastener Spacing	Fastener	Insulation	Panel Seam	Design Pressure
METHOD 1	16"	#14	4" – 6" (max.)	Single Lock	- 116 PSF
METHOD 2	16"	#14	4" – 6" (max.)	Double Lock	- 142 PSF
METHOD 3	8"	#14	4" – 6" (max.)	Double Lock	- 213.5 PSF

• Allowable design pressure(s) for allowable stress design (ASD).

Install the "Zee-Lock" roof panel assembly in compliance with the installation method listed in this report and applicable code sections of FBC 7th Edition (2020). The installation method described herein is in accordance with the scope of this evaluation report. Refer to manufacturer's installation instructions as a supplemental guide for attachment.

Referenced Data:

1. TAS 125-03 Uplift Test
By Force Engineering & Testing Inc. (FBC Organization ID# TST 5328)
Report # 49-0306T-10A-C, Dated 12/29/10
2. Quality Assurance
UL, LLC (FBC Organization #: QUA 9625)
3. TAS 125-03 Uplift Test (Per UL580-06 and UL 1897-12)
By Force Engineering & Testing Inc., Inc. (TST ID: 5328)
Report # 49-0104T-19A, Report Date: 7/24/19
4. Equivalency of Test Standard Certification
By James L. Buckner, P.E. @ CBUCK Engineering
(FBC Organization # ANE 1916)
5. Certification of Independence
By James L. Buckner, P.E. @ CBUCK Engineering
(FBC Organization # ANE 1916)
6. Engineering Analysis
By CBUCK Engineering

Installation Method
Berridge Manufacturing Company
“Zee-Lock” (22 gauge Steel) Roof Panel attached to Steel Deck

Drawings

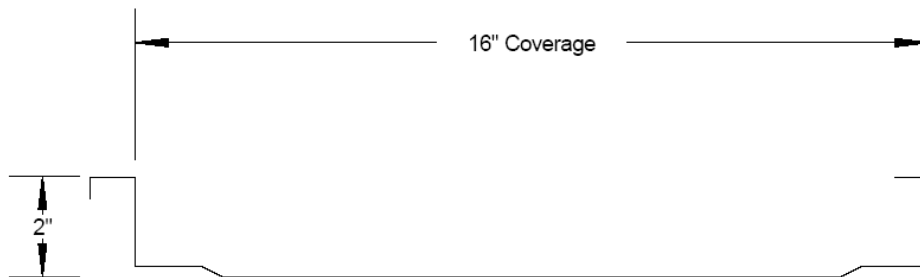

Typical Panel Profile

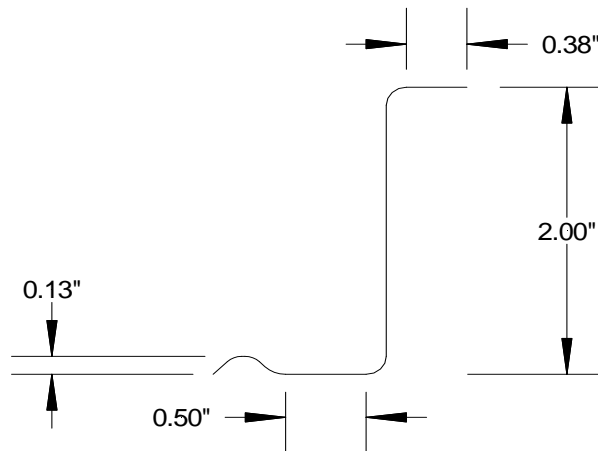

Continuous “Zee-Rib” Panel Clip
Profile Side View

Installation Method Berridge Manufacturing Company "Zee-Lock" (22 gauge Steel) Roof Panel attached to Steel Deck

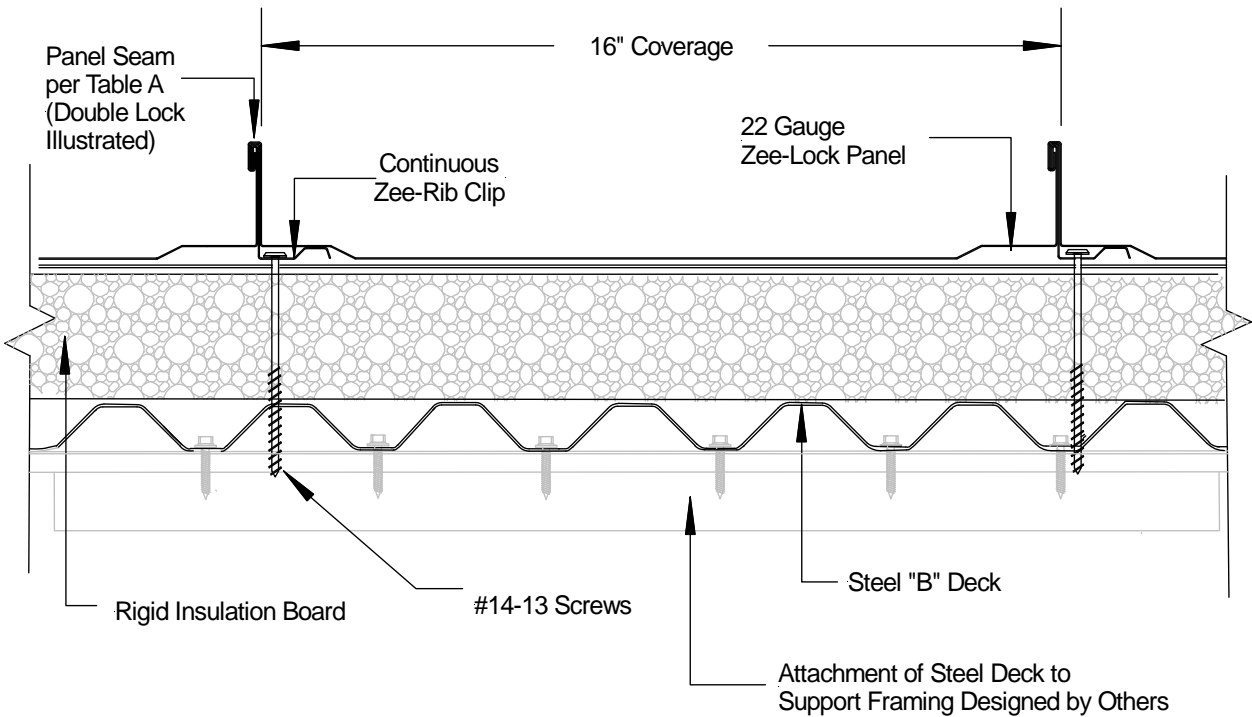

Typical Assembly Profile View
(Typical Fastening Pattern Across Width)

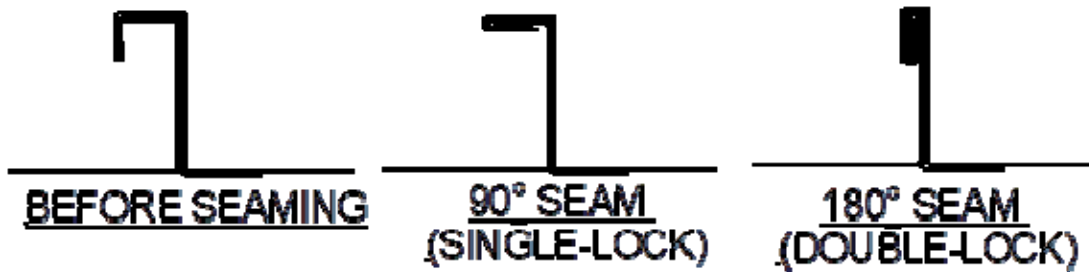

Typical Panel Seams

Installation Method Berridge Manufacturing Company "Zee-Lock" (22 gauge Steel) Roof Panel attached to Steel Deck

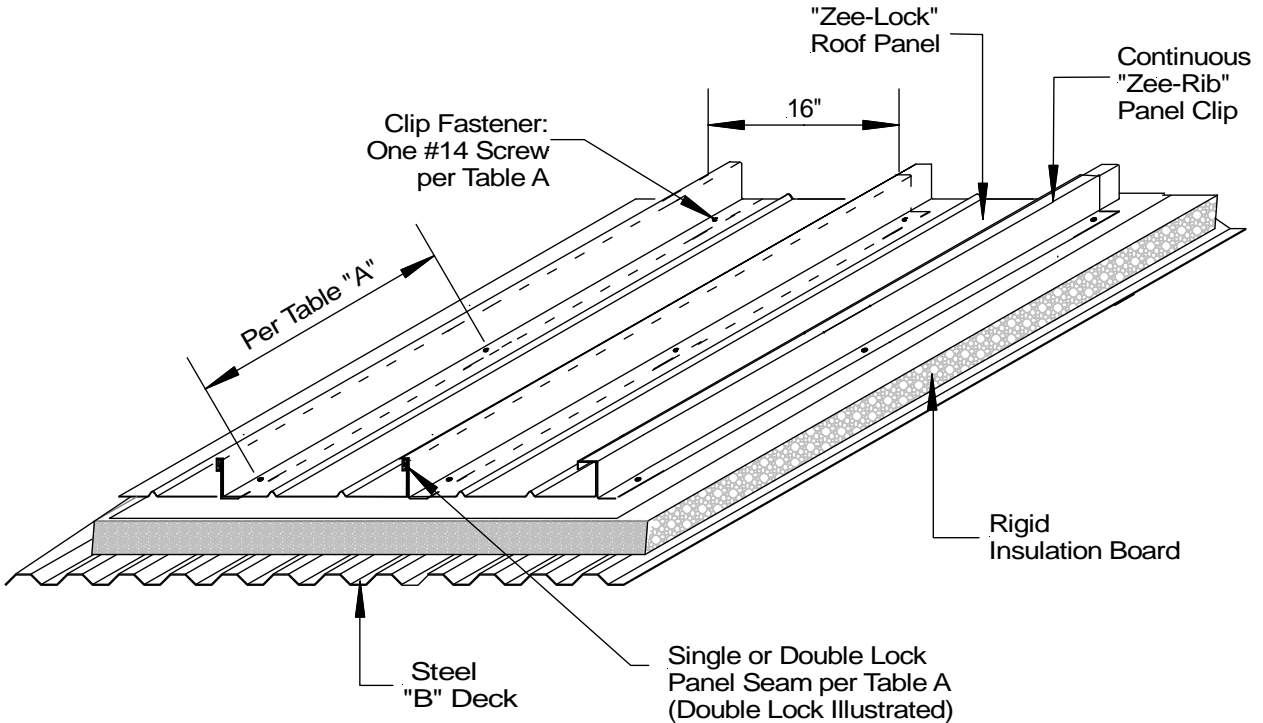

**Typical Roof Assembly
 Isometric View**

TABLE "A"					
ALLOWABLE LOADS					
	Fastener Spacing	Fastener	Insulation	Panel Seam	Design Pressure
METHOD 1	16"	#14	4" – 6" (max.)	Single Lock	- 116 PSF
METHOD 2	16"	#14	4" – 6" (max.)	Double Lock	- 142 PSF
METHOD 3	8"	#14	4" – 6" (max.)	Double Lock	- 213.5 PSF

• Allowable design pressure(s) for allowable stress design (ASD).

Installation Method Berridge Manufacturing Company "Zee-Lock" (22 gauge Steel) Roof Panel attached to Steel Deck

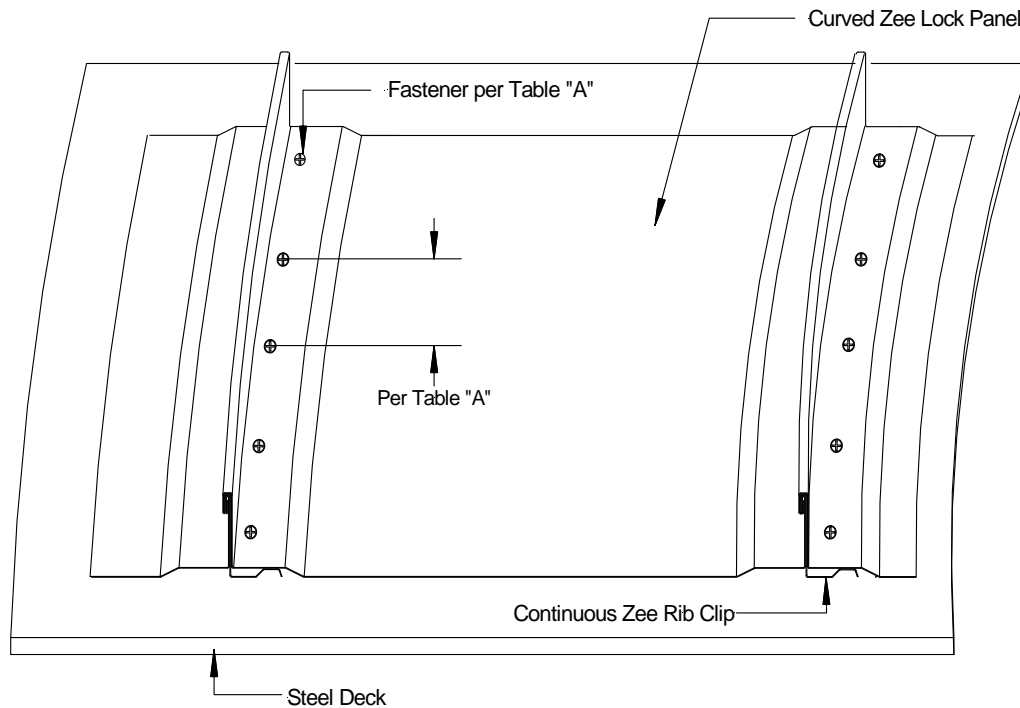

**Typical Curved Roof Assembly
 Isometric View**

TABLE "A"					
ALLOWABLE LOADS					
	Fastener Spacing	Fastener	Insulation	Panel Seam	Design Pressure
METHOD 1	16"	#14	4" – 6" (max.)	Single Lock	- 116 PSF
METHOD 2	16"	#14	4" – 6" (max.)	Double Lock	- 142 PSF
METHOD 3	8"	#14	4" – 6" (max.)	Double Lock	- 213.5 PSF

• Allowable design pressure(s) for allowable stress design (ASD).