



May 26, 2017

Attention: Mr. Richard S. Browdy  
Chairman, Florida Building Commission  
6944 St. Augustine Road, Suite D  
Jacksonville, Florida 32217

Subject: Modification to Proposed 2017 Florida Building Code - Alternate  
Lightning Protection Standard Reference

Reference: Proposed 2017 Florida Building Code

Dear Mr. Browdy,

We are writing to request the addition to recently modified lightning protection requirements that will be included in the 2017 Florida Building Code. The proposed lightning protection section will appear as follows:

Section 2703 Lightning Protection

2703.1 Lightning Protection. A lightning protection system shall be provided for all new buildings and additions in accordance with NFPA 780, Standard for the Installation of Lightning Protection Systems.

2703.2 Where additions are constructed to existing building, the existing building's lightning protection system, if connected to the new lightning protection system, shall be inspected and brought into compliance with current standards.

2703.3 Surge protection devices shall be installed for all normal and emergency electrical systems in accordance with NFPA 70, National Electrical Code.

Exceptions:

1. One- and two-family dwellings

2. Lightning protection shall not be required for any building or addition where shown unnecessary by evaluation using the Risk Assessment Guide in NFPA 780, Standard for the Installation of Lightning Protection Systems or an alternative method approved by the authority having jurisdiction.

The current wording of the proposed Section 2703.1 only includes a reference to NFPA 780, Standard for the Installation of Lightning Protection Systems and does

not include a reference to UL 96A, Installation Requirements for Lightning Requirements. NFPA 780 is a Standard which provides guidance to lightning protection designers. UL 96A provides additional design guidance but also defines inspection parameters to validate the installation of lightning protection components. Thus, the two standards are meant to go hand in hand and should be referenced in tandem. Therefore, we propose Sections 2703 to be modified as highlighted below:

Section 2703 Lightning Protection

2703.1 Lightning Protection. A lightning protection system shall be provided for all new buildings and additions in accordance with NFPA 780, Standard for the Installation of Lightning Protection Systems and UL 96A, Installation Requirements for Lightning Requirement .

2703.2 Where additions are constructed to existing building, the existing building's lightning protection system, if connected to the new lightning protection system, shall be inspected and brought into compliance with current standards.

2703.3 Surge protection devices shall be installed for all normal and emergency electrical systems in accordance with NFPA 70, National Electrical Code.

Exceptions:

1. One- and two-family dwellings

2. Lightning protection shall not be required for any building or addition where shown unnecessary by evaluation using the Risk Assessment Guide in NFPA 780, Standard for the Installation of Lightning Protection Systems or an alternative method approved by the authority having jurisdiction.

UL is a global safety-focused company with over 120 years of proven excellence in safety, science, technology, research and integrity. Our mission is to advance safety science through careful research and investigation, applying our efforts to prevent or reduce loss of life and property and to promote safe living and working environments for all people. UL has been a leader in ensuring electrical safety in buildings and products since its founding in 1894. UL standards, such as UL 96A, help ensure the safe installation and operation specialized products for the built environment and our standards are developed and updated through an ANSI consensus process.

In support of UL Standard 96A, UL has developed a Lightning Protection Application Guide, which is provided in Annex A. The Application Guide provides a detailed explanation of typical Lightning Protection Installations, details of inspection requirements defined by UL 96A, Installation Requirements for Lightning

Requirements and an explanation of ongoing validation. The subject UL Application Guide is publically available at [www.ul.com/codeauthorites](http://www.ul.com/codeauthorites).

Presently there are over 50 lightning protection component (i.e. Air Terminals, Fittings, Lightning Conductors, etc.) manufacturers that maintain UL Listings. Lightning Protection System Components, are Listed under UL Product Category, Lightning Conductors, Air Terminals and Fittings (UL Product Category Code OVTZ).

Additionally, there a 100's of Lighting Protection Systems that are currently installed using UL Listed Lightning Protection Components and covered under UL Product Category, Lightning Protection System Installations (UL Product Category Code OWAY). Both UL Product Categories are publically accessible at [www.ul.com/databse](http://www.ul.com/databse).

In conclusion, we ask the Florida Building Commission to revise the purposed 2017 Florida Building Code requirements to include a reference to UL 96A, Installation Requirements for Lightning Requirements. UL 96A and NFPA 780 used in tandem will adequately cover the installation of Lightning Protection Systems and provide the Authority Having Jurisdiction the necessary guidance and reference to approve safe code compliant Lightning Protection Installations.

Thank you,

*Jonathan Roberts*

Jonathan Roberts  
Lead Regulatory Engineer  
UL LLC  
E:Jonathan.roberts@ul.com



Alfredo M. Ramirez  
Regional Manager  
UL LLC  
E:Alfredo.m.ramirez@ul.com

CC: Mo Madani ([mo.madani@myfloridalicense.com](mailto:mo.madani@myfloridalicense.com))

## **Annex A – UL Lightning Protection Application Guide**



*Marking and Application Guide*

# **LIGHTNING PROTECTION**

Lightning Protection  
Marking and Application Guide

**JULY 2016**

## PREFACE

With the increased use of sensitive electronic equipment and greater awareness of structural protection, the need for certified lightning protection is increasing. Lightning protection systems installed by contractors, can be Certified/Listed by UL using the UL96A, Standard for Installation Requirements for Lightning Protection Systems, or NFPA 780, Standard for the Installation of Lightning Protection Systems. The installing contractors use UL Certified/Listed products evaluated to UL 96 Standard, Lightning Protection Components. Certified/Listed products, correct installations in accordance with the standards, combined with a skilled installer can assure that the system will become certified when completed and field evaluated by UL.

The equipment and systems used for lightning protection are required to comply with the National Electrical Code, NFPA 70 and installation requirements. NFPA 70 and NFPA 780 require compliance with different standards and installation requirements.

UL has developed this guide for use by code authorities, electric utilities, contractors, installers, users, system designers, and other interested parties to aid in understanding the basic components of lightning protection systems and the applicable codes and standards in order to facilitate a reasonably safe and code-compliant installation.

UL Marking and Application Guides are updated as necessary due to new product development, changes in the codes, or the need for clarification. To confirm the current status of any UL Marking Guide, please consult the Code Authorities page of the UL Web site at [www.ul.com/codeauthorities](http://www.ul.com/codeauthorities) or [www.ul.com/markingguides](http://www.ul.com/markingguides).

Your comments or suggestions are welcome and appreciated. They should be sent to:

Regulatory Services Department  
UL  
333 Pfingsten Road  
Northbrook, IL 60062  
[ulregulatoryservices@us.ul.com](mailto:ulregulatoryservices@us.ul.com)  
800-595-9844

UL Knowledge Services ([www.ulknowledgeservices.com](http://www.ulknowledgeservices.com)) provides workshops to learn the key elements of UL 96A and its practical application. Attendees learn how UL 96A and NFPA 780 relate to each other. Helpful calculation tools for determining a zone of protection are provided.



## TABLE OF CONTENTS

Title	Page
INTRODUCTION .....	02
1. Definitions .....	06
2. Structure Protection .....	10
a. Air Terminal Placement .....	10
b. Rolling Sphere Design .....	12
c. Protective angle .....	13
3. Heavy Duty Stacks .....	16
4. Components Selection .....	16
5. Basic Requirements for System Certification and .....	
UL Master Label Certification Program .....	18
6. Summary .....	19
APPENDIX A: UL Lightning Protection Product Categories .....	20
APPENDIX B: UL Lightning Protection Codes and Standards .....	21



## **INTRODUCTION**

### **USE OF THIS GUIDE**

This guide is intended to assist code authorities, designers, and installers to develop, and install a complete lightning protection system that can withstand the tremendous power of a lightning strike. Depending on the type, a strike can exceed 300,000 Amperes, over one gigavolt (one billion volts) and with temperatures as high as 36,000 Deg. F., or about three times as hot as the surface of the sun. This guide does not include information on protection of equipment inside a building.

The dissipation of a lightning strike requires correct system design, installation in accordance with UL 96A, NFPA 780 and all listed components correctly installed and connected to earth. And common bonded to the building electrical system in accordance with Article 230, 250, 280, 800 and 810, of the NEC. This installation guide covers definitions and installations used on virtually all types of structures designed and built today. The installation must be designed to protect the entire structure not just a small portion or section of the structure.

It should be understood that this application guide is not a substitute for the correct use of the UL and NFPA Installation Standards that are published and could be adopted by a jurisdiction. Its intent is to simplify and help the user better understand the concept of developing a correct protection scheme for a structure.

### **UL LISTED AND CLASSIFIED PRODUCTS AND MASTER LABEL CERTIFICATE**

System components that are described in this application guide are evaluated in accordance with UL 96, the Product Standard for Lightning Protection Components and are Certified/Listed by UL under an appropriate product category. A four-letter code (shown in parenthesis) following every category title in this guide is the UL product category code designation. A list of lightning protection equipment and related product categories evaluated by UL, along with the applicable standard(s), can be found in Appendix A.

Each UL product category code provides a direct link to the Guide Information for the product category. The Guide Information includes the scope of the products covered, information relating to limitations or special conditions applying to the product, the requirements used for the investigation of the products, installation and use information, and information on product markings and the UL Mark to be used on the product. Guide information is available on UL Product Spec at [www.ul.com/productspec](http://www.ul.com/productspec) and on UL's Online Certifications Directory at [www.ul.com/database](http://www.ul.com/database).

The product markings identified in this Guide do not include every possible marking that could be provided either on a product or in its installation or operation instructions. The purpose of this Guide is to provide you with an indication of the type of text and location of markings that address features that may be critical in determining if a product is certified and / or if it is installed correctly. Refer to the specific Guide Information for the product category for additional marking information.

The numbering for code sections used in this document may change as the specific code is updated. A list of model codes and standards applicable for each product can be found in Appendix B.



Additional information can be found at [www.ul.com](http://www.ul.com).

Lightning Protection System components are intended to be installed and used in accordance with UL 96A, the Standard for Installation Requirements for Lightning Protection Systems, . Following the installation of the lightning protection system it can be site inspected and a UL Master Label Certificate will be issued to compliant systems. The on-site inspection process provides assurance that the Lightning Protection System complies with the appropriate Standards. The system certification has a five-year life span. After five years, the system must be re-certified through a site inspection and a new certificate issued. This five-year re-inspection program takes into consideration any possible damage from a lightning strike, possible damage by maintenance personnel walking on components, building structural changes or possible remodeling.

### **INFORMATION ON CERTIFICATION, LISTING AND CLASSIFICATION**

Most codes and regulations require the certification of this equipment to applicable safety-related standards. They also may require this equipment to be certified to energy performance standards as well. Products that are certified to safety-related standards have been evaluated with regard to all reasonably foreseeable safety-related hazards, including fire, electrical shock and mechanical hazards. Such products are termed "UL Listed." Products that are certified to a limited range of hazards, or for use under specific conditions are termed "UL Classified". Alternatively, any of these products can be "UL Certified" and bear the UL Certification Mark.

It is important to distinguish the difference between "UL Listed" and "UL Classified" and the relation these terms have with the term "listed," as used in various codes. The term "listed" in the codes generally indicates that the product is required to be evaluated in accordance with the appropriate standard(s) by an independent third party certification organization such as UL. The term "listed" in the codes should not be confused with the term "UL Listed," as explained above. It is important to recognize that not all certification agencies make this distinction in their certification services.

### **INFORMATION ON UL MARKS**

There are several types of UL Marks that can be found on lightning protection related equipment. General information on each of these Marks is provided below. Each has its own specific meaning and significance. The only way to determine if a product has been certified by UL is to look for the UL Mark on the product itself.

The UL Mark on a product means that UL has tested and evaluated representative samples of that product and determined that they meet the requirements in the applicable standard(s). Under a variety of UL programs, certified products are periodically checked by UL at the manufacturing facility to determine that they continue to comply with the standard(s).

The UL Marks may only be used on, or in connection with products certified by UL, and under the terms of a written agreement between the manufacturer and UL.

### **UL CERTIFIED PRODUCTS**

Launched in mid-2013, the enhanced UL Certified Mark can be used on both UL Listed and Classified products and is intended to make it easier and simpler for stakeholders to understand the scope of UL's certifications of a specific product. The enhanced UL Certified Mark makes it possible to bundle multiple UL certifications for multiple geographies into a single Mark design. Today, this mark is used for products certified to U.S., Canadian, European and Japanese requirements. This Mark utilizes a unique identifier to enable stakeholders to search UL's Online

Certifications Directory at [www.ul.com/database](http://www.ul.com/database) to quickly to review detailed certification information.

All currently existing versions of UL's Listing and Classification Marks remain valid and should continue to be accepted as an indication of certification.

UL expects the transition to the enhanced Mark to happen over time, so you may not see it in the immediate future. For more information on this important development, please go to [www.ul.com/markshub](http://www.ul.com/markshub) > Resources. Access to the Marks Hub is free and open to all regulators, but registration to use it is required.



#### UL Listing Mark

This is one of the most common UL Marks. If a product carries this Mark, it means UL found that representative samples of this product met UL's *safety* requirements. These requirements are primarily based on UL's own published Standards for Safety, or other recognized third party standards. The UL Listed Mark includes the UL symbol, the word "Listed," the product or category name, and a control number assigned by UL.



### UL Classification Mark

This Mark appears on representative samples of products that UL has evaluated but only with respect to specific properties, a limited range of hazards, or suitability for use under limited or special conditions. The UL Classified Mark includes the UL symbol, the word “Classified,” a statement of the scope of evaluation, the product or category name, and a control number assigned by UL.



### FIELD EVALUATIONS

You may encounter situations in which you are unable to determine if a product has been listed by a third-party organization. Or in other situations you might encounter a product bearing a listing label that may have been modified in the field, and now you question whether or not the product still complies with the applicable standard. UL offers a field evaluation service that provides data to assist you in making your decision whether to accept the product and/or approve the installation. Anyone directly involved with a product – including manufacturers, owners, contractors, and regulatory authorities – can request a Field Evaluation. Detailed information for this program can be found on UL’s Web site at [www.ul.com/field](http://www.ul.com/field).



## 1. DEFINITIONS

**AIR TERMINAL** – A type of strike termination device intentionally installed for the purpose of intercepting lightning flashes. These items are sometimes referred to as lightning rods.

**BONDING** – An electrical connection between an electrically conductive object and a component of a lightning protection system with secondary conductor that is intended to significantly reduce potential differences created by lightning currents.

**BUILDINGS:**

- a) Ordinary Building – A building of common or conventional construction used for ordinary purposes, whether commercial, farm, industrial, institutional, or residential.
- b) Class I Ordinary Building – A building that is not more than 75 feet (22.9 m) high.
- c) Class II Ordinary Building – A building that is more than 75 feet (22.9 m) high or greater.
- d) Metal-Clad Building – A building with either sides or roof made of or covered with sheet metal.
- e) Metal-Framed Building – A building with electrically continuous framing of sufficient size and conductivity to be used as part of the lightning protection system.

**CHIMNEY** – A smoke or vent stack not meeting the requirements of a heavy-duty stack.

**CONDUCTOR** – The portion of a lightning protection system intended to transfer lightning discharge currents between strike termination devices and ground or to provide potential equalization between conductive bodies in/on the structure.

- a) Main Conductor – A conductor intended to conduct primary lightning currents that interconnects strike termination devices with grounding electrodes.
- b) Secondary Conductor – A conductor that connects metal bodies within the zone of protection to the lightning protection system to eliminate electrical potential that may create arcing.

**EARTH** – Finished grade level around a structure.

**FASTENER** – An attachment to secure a conductor to a structure.

**GROUND GRID** – A system of grounding electrodes consisting of interconnected bare cables buried in the earth to provide a common ground.

**GROUNDING ELECTRODE** – That portion of a lightning protection system extending into the earth, such as a ground rod, ground plate, or conductor, serving to bring the lightning protection system into electrical contact with the earth.

**GROUNDING** – Connected to earth, or to a conductive material that is connected to earth, so that electric charges are distributed freely to the earth.

**LIGHTNING PROTECTION SYSTEM** – A complete system of strike termination devices, conductors, grounding electrodes, interconnecting conductors, surge protective devices, connectors or fittings.

**LOOP CONDUCTOR** – A conductor:

- a) That encircles a structure; and
- b) That is used to interconnect grounding electrodes, main conductors, or other grounded bodies.

**METAL BODY:**

- a) Grounded (Non-Isolated) Metal Body – A metal body having a ground path independent of the lightning protection system.
- b) Isolated (Ungrounded) Metal Body – A metal body having no ground path.

**ROOF, FLAT OR GENTLY SLOPING** – A roof having a span of 40 feet (12.2 m) or less and a pitch of less than 1/8, or a roof having a span exceeding 40 feet (12.2 m) and a pitch less than 1/4. Roof pitch is determined by the method illustrated in Figure 5.1.

**Figure 5.1**  
**Determination of roof pitch**

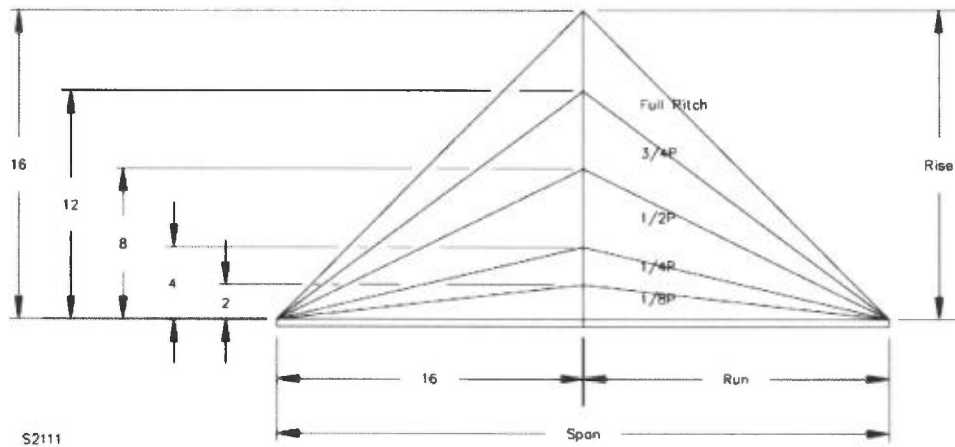

S2111

$$\text{Pitch (P)} = \text{Rise} / \text{Run}$$

Example: If Rise = 3 units, and Run = 12 units, Pitch =  $3/12 = 1/4$

**Figure 5.2**  
**Roof types**

(Top and end views of each roof type are shown)

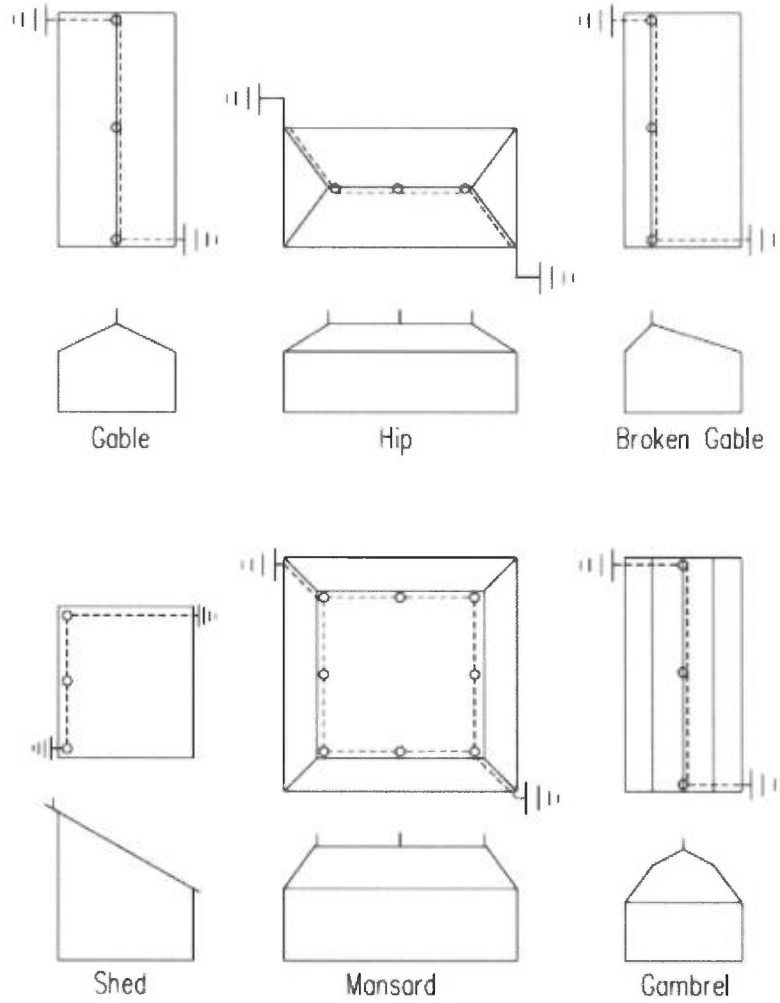

○ = Air Terminal

----- = Conductor

⊥ = Ground

S2112B

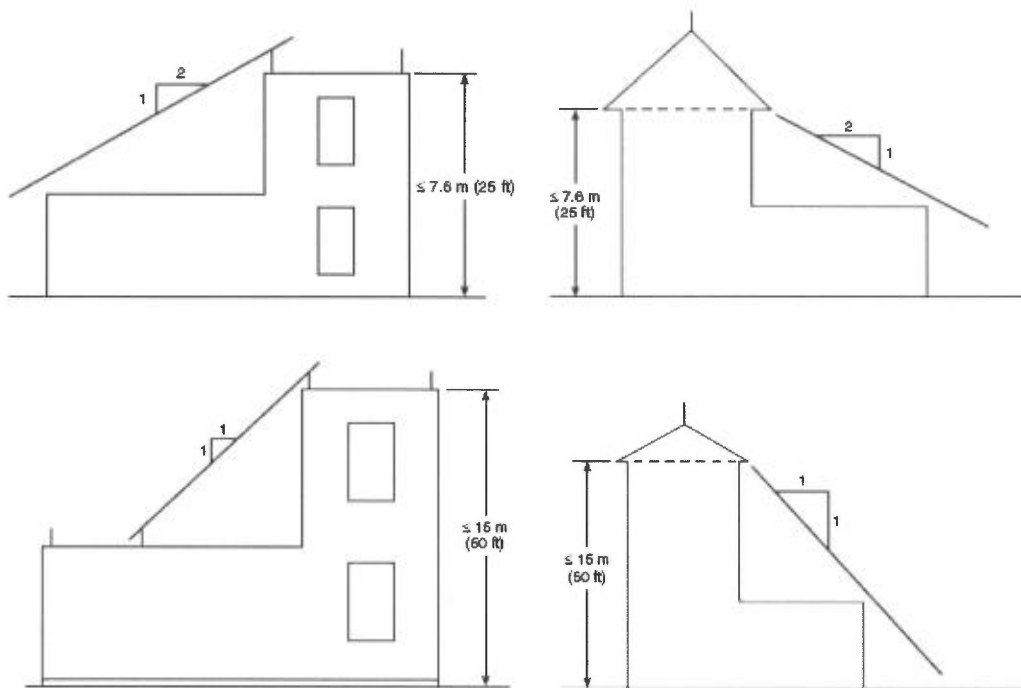

**SECONDARY ROOF AREA** – A secondary roof is less than 10 percent of the total roof area of the protected building and lower than adjacent roofs.

**STACK, HEAVY-DUTY** – A smoke or vent stack more than 75 feet (22.9 m) high, and in which the cross-sectional area of the flue is more than 500 square inches (0.3 m<sup>2</sup>).

**STRIKE TERMINATION DEVICE** – A metallic component of a lightning protection system that intercepts lightning flashes and connects them to a path to ground.

**STRIKING DISTANCE** – The distance over which final breakdown of the initial strike to ground or to a grounded object occurs.

**SURGE PROTECTIVE DEVICE (SPD)** – A device composed of at least one non-linear component and intended for limiting surge voltages on equipment by diverting or limiting surge current and is capable of repeating these functions as specified.

**ZONE OF PROTECTION** – The space adjacent to a grounded air terminal or mast or overhead ground wire that is substantially immune to direct strokes of lightning.



## 2. STRUCTURE PROTECTION

Determining the correct methodology for designing a system of protection is critical to its efficiency and functionality. An average size structure, with a simple roof type, one roof elevation, no uneven vertical changes, and the protection techniques can be rather straightforward and easy to design.

However, if the building structure becomes complex with changes in roof elevations such as a multi-story section, defined shapes such as dormer projections, or tall objects such as stacks, it will require different considerations for design to afford proper protection of the entire structure.

There are three basic methodologies for determining a protection design scheme. Each of the methods listed below is important, and can be used to develop an effective basic design.

The protection schemes shown here are considered Class I; those are buildings less than 75 feet in height.

For Class II structures (those exceeding 75 feet in height or structures such as stacks, steeples etc.) the protection shall include those for Class I but with Class II Air Terminals, cable connectors and splices shall be bolted or welded and rated Class II.

Cable and cable connectors for Class II shall be rated as such and conductor cable shall be rated Class II and be continuous from air terminal to ground and interconnected with the balance of the system.

a. **Air Terminal Placement** using the standard grid placement scheme.

When establishing a zone of protection the air terminal tip is located at not less than 10 inches above the protected object if the interval spacing is not more than 20 feet between air terminals. If a 24-inch air terminal is used, the air terminal spacing may be increased to 25 feet

When the roof exceeds 50 feet in length or width or both directions the spacing can be increased up to 50 feet between terminals on flat or gently sloping roofs. Pending roof design, air terminals may be permitted to be in a pattern not exceeding 50 feet apart in the center part of the roof plan. The perimeter edge spacing can be up to 25 feet between terminals when 24-inch air terminals are used.

When the roof is pitched with eaves height of 50 feet or less above grade and having no structural projections such as roof dormers or other projections, it requires protection only be mounted to the ridge of the projection roofline. Air terminals can be mounted on the ridge at spacing not greater than 25 feet. If other projections or are present such as a dormer, irregular roof lines or lower or higher elevations that area may need air terminal placement based on its physical size and shape. Air terminals 10 inches in height and spaced not greater than 20 feet apart are permitted, interval spacing may be increased to 25 feet when 24-inch terminals are installed.

The figures below (fig. 8.1 & 8.2) will illustrate the typical roof protection scheme for most installations with flat roof structures that would be found on warehouse, strip malls and many commercial office structures. Air terminal spacing can be either 20 or

25 feet pending on terminal height. Perimeter and down conductors, with connections to ground rods are also shown.

Figure 8.1  
Flat or gently sloping roof

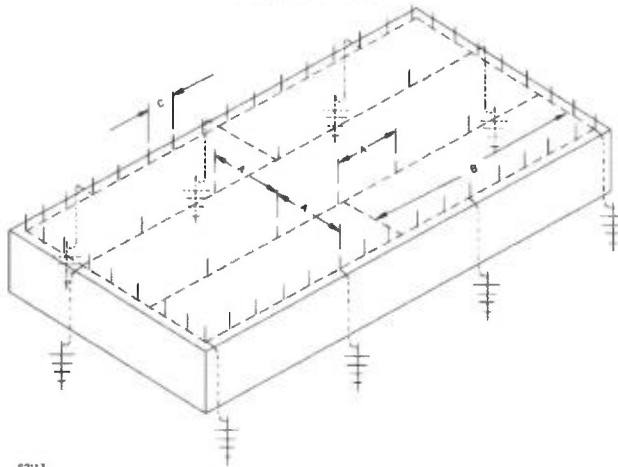

S2113

Figure 8.2  
Air terminal locations

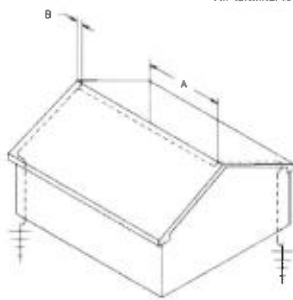

A= 50 ft.  
B= 150 ft.  
C= 20 or 25 ft  
pending air terminal  
Height and not more  
than 2 ft from roof  
edge.

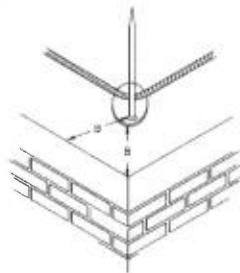

S2114

Figure 8.3  
Air terminals

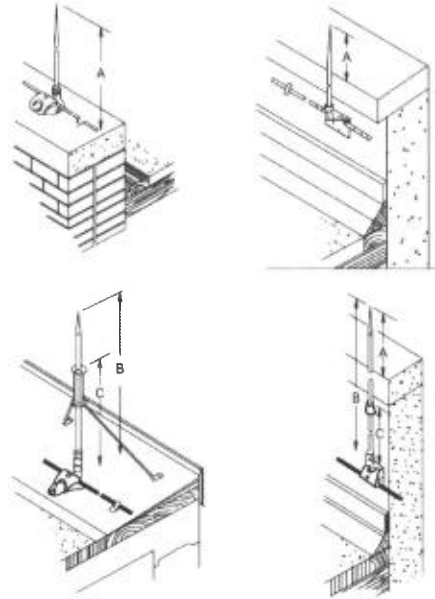

A= 10 inches minimum height  
B= 24 inches or more in height  
C= support shall be located at  
not less than one half the height  
of the terminal

321104

A = Air terminal minimum height. See 8.2.2.1.

B = Air terminal total height. See 8.1.6.

C = Air terminal support height. See 5.1.6.

#### b. **Rolling Sphere Design.**

The rolling ball or more correctly the rolling sphere method uses an imaginary spherical shaped ball with a 150-foot radius that rolls over the building structure touching only the tips of the air terminals mounted on the roof. This dimension is based on the fact that the lightning strike distance near the surface of the earth is about 150 ft. or less. The sphere is tangent to earth and will contact three or more correctly spaced air terminals when rolled over any portion of the roof structure.

When using this imaginary sphere and rolling up over and down the other side of the building, it will only touch the roof mounted air terminals, never the building structural roof surfaces. When using the spherical shape to determine the zone of protection for the building structure all possible placements of the sphere on the structure shall be considered for terminal placement.

A protected building that exceeds the height of the lower building structure will protect the lower structure when it lies within the zone of protection of the rolling sphere. Remember that the protective sphere has a 150 ft. radius or is really a 300 foot diameter round ball.

A protected building that is more than a 150 feet high will provide protection for lower elevation roof areas of adjacent, or connected structures, when the lower structure

roof is protected by the arc of the sphere that is tangent to the side of the protected

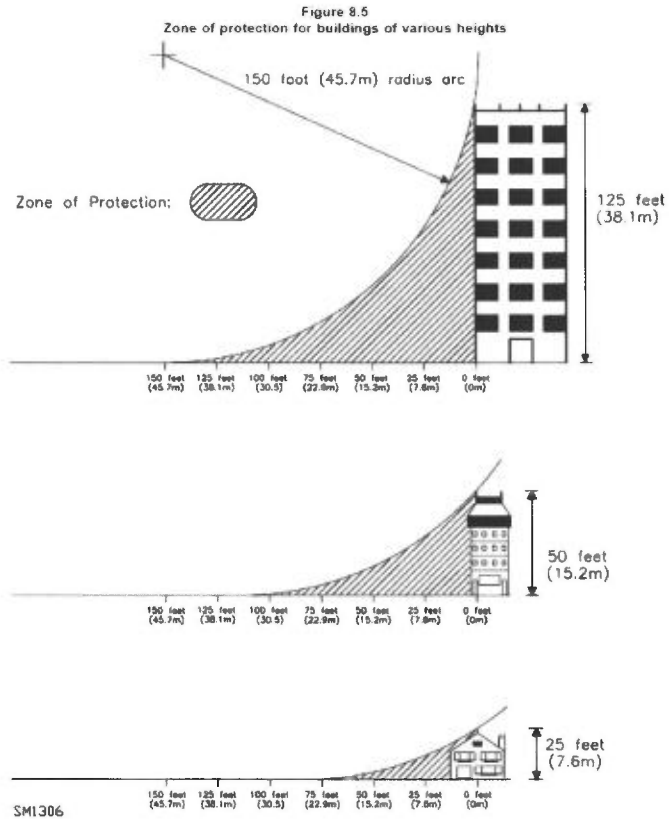

building, and to the earth.

### c. Protective angle

The protective angle method is not depicted diagrammatically in UL 96A but is based on a ratio of upper building height and size to lower building area height and size with location and placement of air terminals. These methods do not apply to structures over 50 ft. in height. Methods A, B should be utilized.

If not more than 25 feet to the lower eaves, a 2:1 ratio (2 horizontal feet of building coverage for each vertical foot in elevation) can protect the lower portion of a building or out to the first air terminal location on a large roof structure. If not more than 50 feet to the eaves or to the perimeter air terminal location on a higher flat roof, the lower roof is protected by the higher roof in a 1:1 ratio (1 foot horizontal coverage for each vertical foot from the upper structure). This ratio would also cover the larger flat roof to the first air terminal based on the height ratio. In the diagrams below you can see how this ratio is applied.

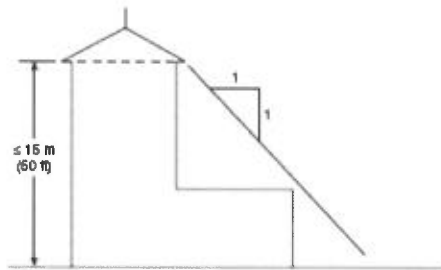
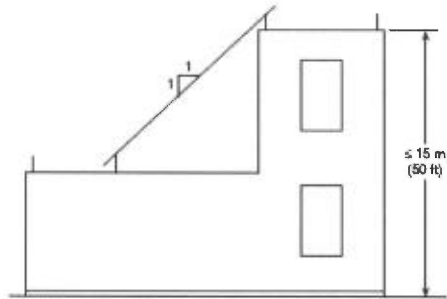
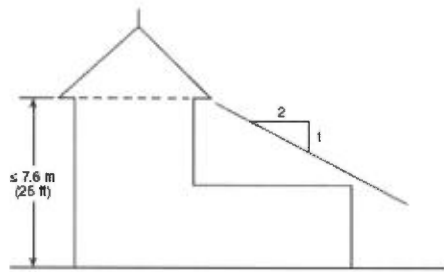
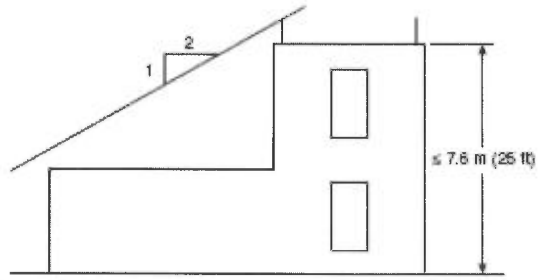

## Heavy Duty Stacks

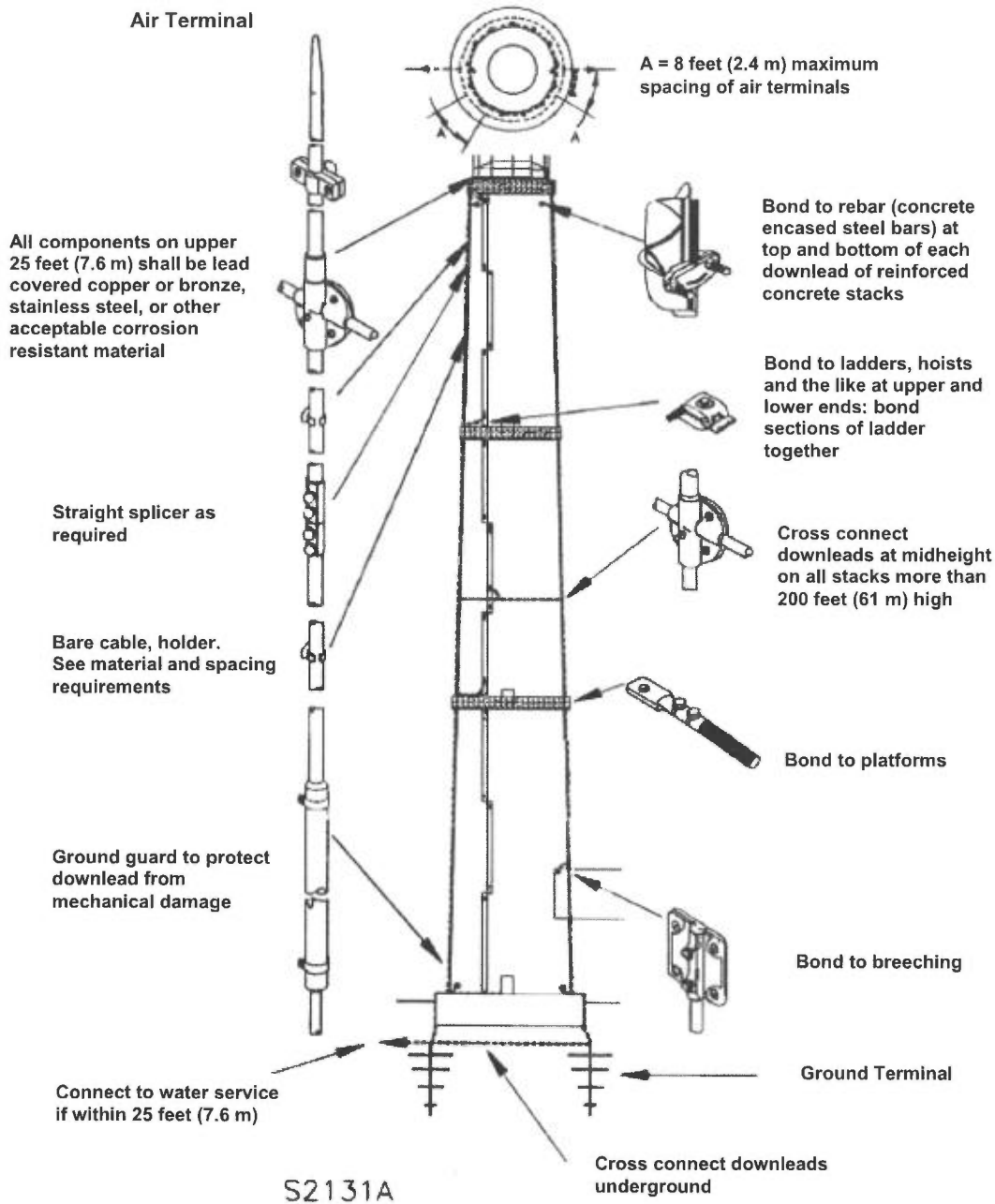

### 3. Heavy-Duty Stacks

Stacks above 75ft in height require some special consideration in both design and material used for the system. All components shall be Class II and class II modified. The components in the upper 25 feet shall be copper, copper alloy, bronze or stainless steel. The top 25 feet can be a high corrosion zone and extra protection of a min of 1/16 in coating of lead is required for terminals, mounting brackets and conductors. Aluminum components are prohibited in this installation.

Class II air terminals on stacks shall be solid copper, copper alloy, stainless steel, titanium or monel metal. The installation shall be evenly distributed around the top of a round stack at intervals not to exceed 8 feet. If the stack is square, the location shall be not more than 2 feet from corners and spaced not more than 8 feet apart.

Each Class II air terminal shall be not less than 18 inches in height and not more than 30 inches in height. The diameter shall be not less than 5/8 inch in diameter. All terminals shall be connected together and there shall be at least 2 down conductors on opposite sides of the stack. Reinforcing steel in concrete stacks shall be electrically continuous and shall be bonded to the lightning protection system at its upper and lower ends at down-lead locations.

### 4. Components Selection

A protection system and its components are really simplistic when you step back and look at the overall system. What is required is a means to catch a lightning strike at some point on the structure, and then conduct it to an electrode buried in the earth so it can be dissipated.

Along the route to earth, terminals, conductors and grounding electrodes minimize damage to the structure and contents within it. However simple as it may appear, there are some complexities along the way. In accordance with NFPA 780, if an LPS component product is listed, labeled per UL 96 than that product shall be selected and installed. The use of listed products gives greater assurance that when correctly installed in accordance with 96A or NFPA 780 that the entire lightning protection system can be "Site inspected" and receive the UL Master Label Certificate. All components used in an LPS shall be of the following: copper, copper alloy, or electrical grade aluminum unless otherwise specified in the UL 96A Standard. Copper components shall not be installed on or in contact with surfaces of aluminum or external galvanized steel surfaces.

Any aluminum or aluminum alloy product shall not come into direct contact with earth, and any bimetallic fitting shall not be installed within 18 inches above earth level. Aluminum products shall not be embedded in concrete or masonry, in direct contact with a surface coated with alkaline paint, installed in wet locations such as inside of eaves or downspouts.

**Air Terminals:** shall be not less than 10 inches long, less than 3/8-inch in diameter and may be manufactured in separate parts if longer than 10 inches. The terminal shall be provided with an integral base support, or shall have not less than five full threads of engagement with a separate attachment base mounted to the structure. If the terminal has internal threads the wall thickness shall be not less than 1/16 inch at the base of the threads. Ornaments or decorations are permitted on air terminals, but shall not exceed 20 square inches in any plane. Air Terminals longer than 24 inches shall have bracing at half its height and listed for the purpose

**Base Supports:** The air terminal bases are permitted to be stamped or cast construction. If stamped, the thickness shall be 0.097 for aluminum and 0.061 for copper material. If cast either copper or aluminum shall be at least 3/32 inches thick. A base support must incorporate a



connector fitting for connection of the lightning conductor. The conductor contact area must be at least 1-1/2 inches on all sides of the cable.

**Air Terminal Braces:** When air terminals exceed 24 inches in height, they shall be braced or supported at least one-half of the terminal height in accordance with section 8.1.6 of UL 96A. The brace shall be at least ¼ inch rod, constructed from aluminum, copper/copper alloy, stainless steel, or hot dipped galvanized if made of steel and shall be flattened on the end for attachment to the structure with at least a 10-24 bolt or screw.

**Conductors:** Lightning conductors do not fall into the basic wire size categories, as most field electricians know them.

**Class I- main conductors:** Stranded copper conductors shall be at least 57,400 circular mils at 187 lbs per 1000 ft. Aluminum conductors shall be at least 98,600 cir.mils at 95 lbs per 1000 ft.

**Secondary** or bonding conductors the minimum size shall be 26,240 cir. mils for copper and 41,100 cir. mils for aluminum

**Class II- main conductors;** shall be not less than 115,000 cir. mils for copper conductor at 375 lbs per 1000 ft and, 192,000 cir. mils. for aluminum conductors at 190 lbs per 1000 ft. Secondary or bonding conductors the minimum size shall be 26,240 cir. mils for copper and 41,100 cir. mils for aluminum.

**Grounding Electrodes:** Air Terminals, main and secondary conductors plus all other ancillary parts are for the sole purpose of conducting a lightning stroke to earth and dissipating it through the use of various grounding electrode methods.

The grounding electrode shall be a rod of not less than ½ inch in diameter, and 8 feet in length and be of copper-clad steel, solid copper, or stainless steel. The rod shall extend vertically not less than 10 feet into the earth and below the frost line where possible.

Concrete encased shall only be used in new construction. It shall be the same diameter as the main-size conductor. It shall be 20 feet in length and be encased in at least 2 inches of concrete. Or Steel rebar shall also be permitted as a grounding electrode. At least 20 feet of (#4 or ½ in dia.) steel reinforcing bar shall be used. Overlapping at least 20-rod diameters shall be maintained if more than one piece is spliced in the footing, using tie wire or welding.

A main-sized conductor can also be buried from each down conductor in the form of a radial. A radial conductor must be at least 12 feet in length and buried at least 18 in depth.

A ground ring shall be permitted if at least 18 inches under the earth and equal in size to the main-size conductor.

Ground plate(s) shall be permitted if 2 sq. feet or more in size and 0.032 in thick or more and buried not less than 18 inches under the soil.

Where there is shallow topsoil, a combination of the methods above shall be permitted to provide an effective means for dissipating a lightning stroke.

**Common Grounding and Bonding:** The lightning protection system grounding system shall be bonded and connected to the grounding electrode system for the electrical service, communication system ground, any antennae system grounds, as well as underground metallic piping systems with main size lightning protection cable and connectors see exception in 10.4.2 for the utilization of ground in accordance with Articles 250, 620,800, and 810.

These systems shall include the water service, well casings located within 25 feet of the structure, gas piping, underground conduits, underground liquefied petroleum gas piping etc. The connection to any utility gas line shall be on the customer's side of the meter. The bonding conductor shall be sized the same as the main down conductor and main system conductor.

## **5. Basic Requirements for System Certification and the UL Master Label Certificate Program**

Once the system is completed, Underwriters Laboratories Field Staff can perform an on-site inspection. The system inspection begins with an overall visual inspection for neat and professional installation of the following but not limited to:

- Air terminal layout and placement position with at least 2 directional paths to ground based in structure elevation, roof style, and projections as specified within the Zone of Protection.
- Air terminals tips shall be a minimum of 10 inches in height above the structure spaced not more than 20 feet apart for perimeter protection
- When terminals greater than 24 inches in height are used, they shall be supported at a point at least half the height the rod and be spaced more than 20 but not less than 25 feet apart for perimeter protection
- Any object elevated above the normal roof height and with a surface thinner than 3/16 inch shall be protected, i.e.: exhaust fan housings, camera masts, etc.
- All lightning protection system components shall be listed, except hardware screws, bolts etc.
- Main size conductors shall be used for bonding the lightning protection system to other systems, including, but not limited to: metallic water systems, steam or hot water heating systems, electric services, telephone systems, antenna grounds, other large grounded metallic masses. See section 10 of UL96A for details..
- The grounding terminal rod shall be at least 8 ft in length and not less than 1/2 in. dia., buried not less than 10 ft plates, concrete encased, rings and trenched systems are permitted as well.
- Copper components are not mounted on aluminum or external galvanized surfaces.
- Cable bend radius at corners or over the building sidewall with 90 deg minimums 8 in radiuses.
- Attachment of cable secured to air terminals, and building shall be secured along the cable run and attachments shall not be more than 3 ft apart.
- Aluminum components shall not be installed in direct contact of copper roof material or below any run off from copper surfaces.
- Aluminum components shall not be in direct contact with earth

- Aluminum down conductors shall be connected to copper conductors using bimetallic fittings within 18 inches of earth.
- Stacks above 75ft in height require Class II components.

## 6. Summary

When we look at a Lightning Protection System in its most elementary form, it is quite simple. An air terminal(s) to attract and catch a lightning strike, a low resistance conducting cable that connects the air terminal to the earth using a conducting electrode and provide a pathway to dissipate the high energy into the earth. This system provides protection for the structure.

While the overall concept may appear to be simplistic in what it takes to get a lightning strike grounded into the earth, there has been a great amount of science and theoretical investigation developed over the last two plus centuries. Today's modern products, such as air terminals, mounting and support hardware, main and secondary conductors conducting the path to earth along with grounding electrodes have undergone testing and evaluation to achieve product listing and compliance with the Standards for installation. The physical science has been studied and modern theories have evolved to help give a structure better protection by maximizing air terminal placement on roof surfaces.

The UL Lightning Protection Master Label Certificate assures that the system has been installed and inspected to the UL 96A Standard. This certification has a 5-year lifespan and can demonstrate that the building has an extra margin for safety for the structure.

## APPENDIX A

### UL LIGHTNING PROTECTION CATEGORIES

UL does list this type of equipment to address the safety issues associated with lightning strikes. Below is a list of product categories that UL currently lists to address these types of products, as well as related product categories. Each product category is tabulated with a UL Category Code. You can view the UL Guide Information for the category and any Listings or Classifications under that Product Category in the UL Online Certifications Directory database at [www.ul.com/database](http://www.ul.com/database) and enter the category code at the category code search field.

Category Code	Category Name	Standard Used
KDER	Grounding and Bonding Equipment	UL 467
<b>OVGR</b>	<b>Lightning Protection</b>	
OVTZ	Lightning Conductors, Air Terminals and Fittings	UL 96
OWAY	Lightning Protection Systems Installations	UL 96A
	<b>Surge Arresters and Surge Protective Devices</b>	
VZCA	Surge Protective Devices	UL 1449
OWIW	Surge Protective Devices Classified for Use in Specified Equipment	UL 1449
VZQK	Surge Arresters Over 1000 Volts	IEEE C62.1 and IEEE C62.11
VZQO	Surge Protectors & Isolators for Use on Cathodically-protected Systems for Use in Hazardous Locations	Hazardous Location standards
XUPD	Surge-protective Device/Panelboard Extension Modules Classified for Use with Specified Equipment	UL 1449 and UL 67
DIMV	Circuit Breakers & Surge-protective Devices	UL 1449 and UL 489
<b>QVGK</b>	<b>Protectors(Communications)</b>	
QVGQ	Isolated Loop Circuit Protectors	UL 497B
QGVV	Primary Protectors for Communications Circuits	UL 497
QVKC	Primary Protectors for Coaxial Communications Circuits	UL 497C
QVLA	Protectors for Antenna Lead-in Conductors	UL Subject 497E
QVRG	Secondary Protectors for Communications Circuits	UL 497A

## APPENDIX B: LIGHTNING PROTECTION CODES AND STANDARDS

Lightning protection equipment must be installed in accordance with model codes and installation standards. These codes require these products to be listed and labeled in accordance with applicable product standards.

UL standards are typically identified as Standards for Safety and cover reasonably foreseeable risks associated with a product. Limitations applicable to the products covered by the standard are delineated in the Scope section of the standard. UL standards are intended to:

- Identify requirements for evaluation of products and provide consistency in the application of these requirements.
- Provide guidance for development of products by manufacturers.
- Provide requirements compatible with nationally recognized installation codes

An UL Outline of Investigation is a document that contains the construction, performance, and marking criteria used by UL to investigate a product when the product is not covered by the scope of an existing UL Standard for Safety. Outlines are not consensus documents and do not require review by an UL Standards Technical Panel (STP) or other external group.

IEEE C62.1	Standard for Gapped Silicon-Carbide Surge Arresters for AC Power Circuits
ANSI/IEEE C62.11	Standard for Metal-Oxide Surge Arresters for AC Power Circuits (>1 kV)
NFPA 70 (NEC)	National Electrical Code
NFPA 780	Standard for the Installation of Lightning Protection Systems
UL 67	Panelboards
UL 96	Standard for Lightning Protection Components
UL 96A	Standard for Installation Requirements for Lightning Protection Systems
UL 467	Grounding and Bonding Equipment
UL 489	Molded-Case Circuit Breakers, Molded-Case Switches and Circuit-Breaker Enclosures
UL 497	Protectors for Paired-Conductor Communications Circuits
UL 497A	Secondary Protectors for Communications Circuits
UL 497B	Protectors for Data Communications and Fire Alarm Circuits
UL 497C	Protectors for Coaxial Communications Circuits
UL Subject 497E	Outline for Protectors for Antenna Lead-In Conductors
ANSI/UL 1449	Surge Protective Devices