

**Gold Coast School of Construction
DBPR Sponsor # 0000983**

**The Practitioner's Guide to the Florida Building Code:
Accessibility Code and Fair Housing Act**

2 Continuing Education hours of Florida Accessibility Code. Construction Industry Licensing Board(0006689); 2 Continuing Education Credit Hours as Technical (T) Electrical Contractor's Licensing Board (0006596); 2 Continuing Education Credit Hours for Dade County Contractors (020); 2 Continuing Education Credit Hours, Intermediate, for the Board of Architecture and Interior Design (AR.01.925); Building Inspector's Board (0006622 - 2 hours Accessibility)

Application to Building Code Commission:

This course has already been approved for continuing education by the various boards as listed above. This application to the Building Code Commission is for the purpose of elevating it to "Advanced" module status, which would mean that it was qualified as an advanced module, and already approved by the various boards.

Gold Coast School of Construction
DBPR Sponsor # 0000983

**The Practitioner's Guide to the Florida Building Code:
Accessibility Code and Fair Housing Act**

2 Continuing Education hours of Florida Accessibility Code. Construction Industry Licensing Board(0006689); 2 Continuing Education Credit Hours as Technical (T) Electrical Contractor's Licensing Board (0006596) ; 2 Continuing Education Credit Hours for Dade County Contractors (020); 2 Continuing Education Credit Hours, Intermediate, for the Board of Architecture and Interior Design (AR.01.925); Building Inspector's Board (0006622 - 2 hours Accessibility)

Course Description : This 2 hour presentation is designed to help the practicing construction professional apply the new Florida Uniform Building Code in her or her day to day practice. It amplifies and clarifies the 4 hour core technical requirement which is now part of the Continuing Education package of the construction professional

Course Objectives :

The objective of the course is assist the construction professional apply the new Florida Building Code. Specifically, at the end of the course students will be able to:

- 1. Identify and Describe key technical components of the Florida Accessibility Code (Chapter 11 of the Florida Building Code)**
- 2. Identify and Describe the 7 technical requirements of the Fair Housing Standards Act (Chapter 11b of the Florida Building Code)**

Course Format :

Classroom : Presentation methods include lecture, overheads, handouts, workshop exercises and selected readings. Methods are selected to maximize student participation and involvement with the course material. Note: materials may be updated as new rules are promulgated.

Verification of Course Objectives :

The course instructor will use class discussions and question and answer periods to confirm that the course objectives have been obtained by students. The instructor will also evaluate student's performance on various exercises and assignments.

Instructors

Each instructor (see attached list and resumes) are evaluated to ensure that they have the background necessary to present the materials in a competent and lively fashion. In addition to basic requirements, Gold Coast Instructors must also complete a "Train the Trainer's " Workshop and have at least 2 years direct or indirect experience working with the topic to be presented

Gold Coast School of Construction

DBPR Sponsor # 0000983

“ The Presidential Series (tm)”

**The Practitioner’s Guide to the Florida Building Code:
Accessibility Code and Fair Housing Act**

2 Continuing Education hours of Florida Accessibility Code Construction Industry Licensing Board(Sponsor # 04P0064); 2 Continuing Education Credit Hours as Technical (T) Electrical Contractor’s Licensing Board (Sponsor # ECLB 99-0088) ; 2 Continuing Education Credit Hours for Dade County Contractors (Sponsor # D-022); 2 Continuing Education Credit Hours, Intermediate, for the Board of Architecture and Interior Design (Previous Course Approvals AR 01.703, AR 08.704)

Course Outline :

| Segment : | Title and Objective, Description | Time |
|--|--|----------------------|
| 11. Florida Accessibility Code Chapter 11 | | |
| | Background and Overview | 00:00 - 00:05 |
| | 11.1 Minimum requirements (11-4.1) | 00:05 - 00:10 |
| | 11.2 Accessible Route (11-4.3) | 00:10 - 00:15 |
| | 11.3 Parking and Passenger Loading Zones (11-4.6) | 00:15 - 00:20 |
| | 11.4 Ramps (11-4.8) | 00:20 - 00:25 |
| | 11.5 Stairs (11-4.9) | 00:25 - 00:30 |
| | 11.6 Elevators (11-4.10) | 00:30 - 00:35 |
| | 11.7 Doors (11-4.13) | 00:35 - 00:40 |
| | 11.8 Entrances (11-4.14) | 00:40 - 00:45 |
| | 11.9 Water Closets (11-4.17) | 00:45 - 00:50 |
| | Break | 00:50 - 01:00 |
| | 11.12 Toilet Rooms (11-4.22) | 01:00 - 01:05 |
| | 11.13 Handrails, Grab Bars and Tub/Shower Seats (11-4.26) | 01:05 - 01:10 |
| | 11.14 Controls and Operating Mechanisms (11-4.27) | 01:10 - 01:15 |
| | 11.15 Alarms (11-4.28) | 01:15 - 01:20 |
| | 11.16 Detectable Warnings (11-4.29) | 01:20 - 01:25 |
| | 11.17 Restaurants and Cafeterias (11-5) | 01:25 - 01:30 |
| | 11.17 Business and Mercantile (11-7) | 01:30 - 01:35 |
| 11 A Fair Housing Act (Chapter 11 Part B) | | |
| | 11A.1 The seven technical requirements | 01:35 - 01:40 |
| | 11A.2 Useable Kitchens and Baths | 01:40 - 01:45 |
| | 11A.3 Common Errors | 01:45 - 01:50 |
| | Summary and Check Out | 01:50 - 01:00 |

Sponsor # 0000983 2 Hours Accessibility & Fair Housing Course Approval Numbers

(In Class):

CILB 0006689; ECLB 0006596(T);Architects AR.01.925;

Inspectors 0006622; Dade 020;

(Internet)

CILB0006690;ECLB0006597(T);Architects

AR.01.925;Inpsectors 0006733; Dade 021

Welcome to the Course !

Register for the first time

Already Registered, continue classes

10/18/2005

1

The Presidential Series : Core Curriculum, Part B
Continuing Education for Contractors, Inspectors and Design
Professionals – 1 hour Business Practices, 1 hour Workplace Safety,
1 Hour Worker's Compensation – Sponsor # 0000983

Welcome to the Course !

Read Me First

Print out the PDF File "Print Me"

Start the First Segment

10/18/2005

2

Workplace Safety

" The grandest of all laws is the law of progressive development : under it, in the wide sweep of things, men grow wiser as they grow older, and societies better. "

Bovee



10/18/2005

3

Florida Accessibility Code

◆ Chapter 11, Florida Building Code

◆ Part A Florida Accessibility Code

◆ Part B Fair Housing Act Guidelines



The information and recommendations contained herein have been compiled from sources believed to be reliable and to represent the best current opinion on the subject. No warranty, guarantee or representation is made by Morrow and Associates or Gulf Coast School of Construction, Inc. as to the absolute correctness or sufficiency of any representation contained herein and no responsibility or liability for same may be assumed.

10/18/2005

4

Goals

- ◆ You will be better able to apply the technical requirements of the Florida Accessibility Code and the Fair Housing Act



10/18/2005

5

What Is the Accessibility Code ?

- ◆ The Americans with disabilities act was signed into law by the Federal government in 1990. It required accessibility accommodations under ANSI guidelines
- ◆ In 1993, Florida adopted the Florida Americans with Disability Implementation act, which in 1997 was amended to provide for the Florida Accessibility Code which was intended to improve consistency between the two laws. In Jan. 2002, The Florida Building Code establishes as part of the building code the Florida Accessibility Code (Chapter 11 part A) and the Fair Housing Standards Act (Chapter 11 part B).



10/18/2005

6

What does this mean

- ◆ Greater emphasis on Accessibility issues
- ◆ Minimum design criteria
- ◆ Increased vigilance required for technical construction details
- ◆ The Florida Accessibility Code prescribes broad rules of design and minimum spacing
- ◆ The Fair Housing Act Integrates and further defines these rules as they relate to the issue of discrimination in housing

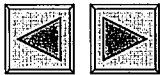

10/18/2005

7

Practitioner's Guide

- ◆ Look at exhibit "Practitioner's Guide"
- ◆ Chapter 11 gives an outline of both the Florida Accessibility Code and the Fair Housing standards act
- ◆ For Example, Notice 1 – A, B & C. These differentiate between New construction, additions and alterations.



10/18/2005

8

From the Practitioner's Guide :

Case Study :

A contractor seeks a permit for a 1 story commercial storefront development.

Which applies ?

Does the Accessibility Code apply ?

Yes

No

Does the Fair Housing act apply ?

Yes

No



10/18/2005

9

- ❖ The Florida Accessibility Code, part A of Chapter 11 would apply. Since this is new construction, this applies fully. In an existing property, a differentiation would be made between an addition and an alteration. In both cases the law would apply, but with an alteration, there are limitations (2)

- ❖ The Fair Housing Act, would not normally apply



10/18/2005

10

Minimum Requirements

- ❖ As a general rule, of thumb, the law places a priority on accessible routes, egress, and accessible facilities.

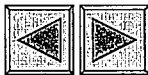

10/18/2005

11

- ❖ As a practical issue this means :

- ✓ Easy access to and from the building
- ✓ Accessible access once inside the building
- ✓ Bathrooms that can accommodate a wheelchair
- ✓ Common areas that can accommodate all

What are some Key Definitions ?

- Accessible Route: A continuous unobstructed path connecting all accessible elements and spaces of a building or facility. Interior accessible routes may include corridors, floors, ramps, elevators, lifts, and clear floor space at fixtures. Exterior accessible routes may include parking access aisles, curb ramps, crosswalks and vehicular ways, walks, ramps and lifts.

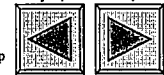

Source: OSHA "Standards Cited for SIC Major Group 15; All sizes; Federal" 1999

10/18/2005

12

Alteration

- ◆ ...a change to a building or facility...that affects or could affect the usability of the building or facility... Alterations include, but are not limited to, remodeling, renovation, rehabilitation, reconstruction, historic restoration, changes or rearrangement of the structural parts or elements, and changes or rearrangement of the structural parts or elements and changes or rearrangement in the plan configuration of walls and full height partitions....



10/18/2005

13

Area of Rescue Assistance

- An area, which has direct access to an exit, where people who are unable to use stairs may remain temporarily in safety to await further instructions or assistance during emergency evacuation.
- COMMON USE : those interior and exterior rooms, spaces, or elements that are made available for the use of a restricted group of people

See Section
11-3
Building
Code



10/18/2005

14

Minimum Requirements

- ◆ -At least 50% of all public entrances must be accessible
- Parking spaces – minimum required per table 11-4.1.2
- All doors part of an accessible route must be accessible
- All doors required by egress must be accessible
- Accessible entrance must be provided to each tenancy in a facility

See 11.4.1
Of the code



10/18/2005

15

Parking and an accessible route 11-4.1 - 3

- ◆ Minimum width of accessible route 36" except at doors
- ◆ Curb egress ramps minimum 44"
- ◆ Accessible ramp with a slope greater than 1:20 is a ramp (see 11.4.8)
- ◆ Parking spaces:
 - ◆ Shortest safe, 44" accessible route
 - ◆ 5' wide parking isles
 - ◆ Parallel spaces even with surface slopes
 - ◆ Min. 114" vertical clearance
 - ◆ Blue paint, Sign



10/18/2005

16

Typical Parking Lot Problems

- ◆ Location of Spaces ?
- ◆ Safe Route ?

In a nutshell:

A person in a wheel chair must be able to park, get out of vehicle, get safely on to an accessible path and enter the building



10/18/2005

17

Ramps (11-4.8)

- ◆ Accessible ramp with a slope greater than 1:20 is a ramp
- ◆ Max. slope 1:12
- ◆ Max. rise for any run 30"
- ◆ Exceptions if space limitations on existing buildings(see 11-4.1.6a)
- ◆ 36" clear width
- ◆ 44" if egress
- ◆ Landings on ramps 60" clear, bottoms 72" if ramp changes direction at landing, 60" x 60" min
- ◆ Handrails required if ramp run has a rise greater than 6" or horizontal projection greater than 72" on both sides but not on curb ramps or adjacent to seating in assembly areas. Clear space to wall 1 1/2"

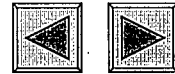

10/18/2005

18

& Stairs (11-4.9)

Handrails

- ◆ Uniform treads and risers, 11" min. width riser to riser
- ◆ Underside of nosing not abrupt, curvature at leading edge no greater than 1/2", Risers sloped or underside of nosing min. 60 degree angle from horizontal. Nosing project no more than 1 1/2"
- ◆ Continuous along both sides of stairs; if not, must extend 12" min. beyond top riser and at least 12" and with of one tread beyond bottom riser. Uninterrupted gripping surfaces; Top handrail between 34" - 44"; rounded or returned smoothly to floor

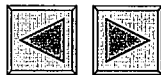

10/18/2005

19

Elevators 11-4.10

- ◆ Must be on accessible route
- ◆ Freight elevators only if only elevator
- ◆ Floor to landing 1/2"
- ◆ Call buttons centered at 42"
- ◆ All must have raised and Braille floor designations on both jambs. 60" Centerline
- ◆ Automatic door opening if obstructed
- ◆ ASME A17.1-1990
- ◆ Minimum delay time 3 seconds
- ◆ 5 footcandles min. illumination
- ◆ Control buttons 3/4" at smallest dimension
- ◆ All control buttons, see figure 23a, 3/4" minimum, raised or flush



10/18/2005

20

Doors 11-4.10

- ✦ Turnstiles not used in occupancies under 100 persons
- ✦ If doorways have two independently operated door leaves, then at least one leaf shall meet 11-4.13.5 - 6
- ✦ Doorways min. clear opening 32"
- ✦ Minimum space between two doors is 48" plus swing
- ✦ Thresholds not exceed 3/4" exterior sliding; 1/2" all other

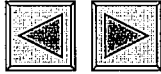

10/18/2005

21

Door Hardware 11-4.13.9

- ✦ Easy to grasp shape one hand operation
- ✦ Max. 48" high
- ✦ If closer, sweep period 3 seconds
- ✦ Door opening force:
 - ✦ Fire doors, per administrative authority
 - ✦ Exterior hinged doors 8.5 lbf
 - ✦ Interior hinged doors 5 lbf
 - ✦ Sliding/folding 5 lbf
 - ✦ Automatic doors - comply ANSI/BHMA A156.10-1985

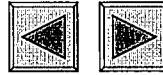

10/18/2005

22

What's Wrong with this Picture ?

- ✦ Door Size
- ✦ Entryway Size
- ✦ Threshold Size

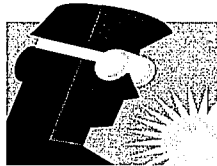

Insert Picture 2 - non compliant door



10/18/2005

23

- ✦ Entrances required to be accessible by 11-4.12 shall be part of an accessible route ...shall be connected by an accessible route to public transportation stops, to accessible parking, to public streets or sidewalks. Also connected to all accessible spaces or elements within the building

- ✦ Service entrance not sole accessible entrance unless only entrance to a building



10/18/2005

24

◆ Water Closets 11-4.16

See figure 28.

Identify the :

1. Clear Floor Space
2. Height
3. Grab Bar height
4. Flush controls
 - a. side
 - b. height

Identify the :

1. Clear Floor Space
2. Height 17 - 19"
3. 36"
4. Flush controls
 - a. wide
 - b. max. 44"



10/18/2005

25

Toilet Rooms 11-4.17

- ◆ Accessible & on accessible route
- ◆ Doors shall not swing into clear floor space



10/18/2005

26

Exception

- ◆ "All new single family houses, duplexes, triplexes, condominiums and townhouses shall provide at least one bathroom located with maximum possible privacy, where bathrooms are provided on habitable grade levels, with a door that has a 29" clear opening. However, if only a toilet room is provided at grade level, such toilet rooms shall have a clear opening of not less than 29"

10/18/2005

27

News Flash – Facts in a Nutshell

- ◆ Clear floor space of fixtures and controls, the accessible route and the turning space may overlap
- ◆ If toilet stalls provided, at least one shall be standard per 11-4.17
- ◆ If more than 6 at least one stall complies with Figure 30(d) outward winging self closing door and parallel grab bars
- ◆ Water stalls comply with 11-4.16



10/18/2005

28

Handrails, Grab bars and Tub/Shower seats 11-4.26

- ◆ Forward or side way approach accounted for in placement of controls
- ◆ Height within at least one of reach ranges in 11-4.2.4 & 6; Electrical and communication no less than 15" above floor
- ◆ Requirements don't apply for special equipment not normally used by occupants
- ◆ Controls one hand operation



10/18/2005

29

What do you Think ?

- ◆ A new 4 story office building provides for an accessible toilet room which is not part of the accessible route through the building
- ◆ Is this an appropriate practice ?
 - YES
 - NO

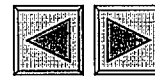

10/18/2005

30

Alarms 11-4.28

- ◆ At minimum, visual signal appliances provided in each of:
 - restrooms
 - general usage areas
 - meeting rooms /
 - hallways
 - lobbies
 - Any other common use

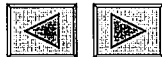

10/18/2005

31

- ◆ Audible, if provided, under 120, at least 5 dba louder than prevailing level in room or space; for 60 seconds
- ◆ Visual alarm signal integrated into building alarm system
- ◆ If single station audible alarms are provided, than single station visual signals shall be provided



10/18/2005

32

Review Questions

- ◆ The minimum door clear space for a typical interior door in a common areas is
 - ◆ 29"
 - ◆ 32"
 - ◆ 34"
- ◆ Which of the following is false about an accessible route leads through an egress hallway ?
 - ◆ The egress hallway can be narrower than the accessible route
 - ◆ The egress hallway can count towards an accessible route
 - ◆ This only affects the subcontractor's employees
 - ◆ This affects everybody on the jobsite

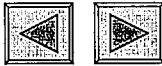

10/18/2005

33

Detectable Warnings 11-4.29

- ◆ Walking surfaces - ANSI A117.1 1986
 - textures such as exposed concrete, raised strips, grooves, figure 40(a) & (b)

Detectable Warnings on Doors to hazardous Areas and Stairs : reserved, more details to come



10/18/2005

34

Detectable Warnings :

- ◆ 36" wide continuous where walks cross or adjoin a vehicular way not separated by curbs, rails, or other elements
- ◆ Reflecting pools - at edges
- ◆ Standardization - reserved, more to come



10/18/2005

35

Restaurants and Cafeterias 11-5 :

- ◆ Fixed tables, 5% (not less than one accessible)
- ◆ In smoking and Non smoking areas, accessible tables proportioned
- ◆ Counters and bars, 60" minimum accessible
- ◆ All fixed tables have 36" min. isles

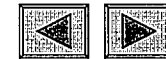

10/18/2005

36

Dining Areas :

- ◆ All areas, in new construction, must be accessible; In alterations accessibility to raised or sunken areas or to all parts of outdoor seating areas not required
- ◆ Vertical accessibility still required, whether elevator required or not

10/18/2005



37

Business and Mercantile 11-17:

- ◆ Sales and service counters, teller windows, information counters - at least 36" long no more than 36" high on accessible route
- ◆ Equivalent facilitation at hotel registration
- ◆ Check out Aisles see table 11-7.3 unless under 500 sq. ft.
- ◆ Alterations, 1 accessible under 5000 sq. ft., over 5000 at least one until equivalent

10/18/2005



38

Fair Housing Guidelines

- ◆ This segment addresses the 7 technical requirements of the Fair Housing Act
- ◆ At the end of this segment you will be able to describe these seven technical requirements

10/18/2005

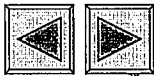

39

3. Fair Housing Accessibility Guidelines (Part B, Chapter 11, HUD)

- ◆ Now incorporated into code
- ◆ Is a discrimination, not a strictly a building code

10/18/2005

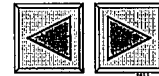

40

1. Definitions

- 1. Accessible: When used in context of public and common use areas of a building containing covered multifamily dwellings means that the public or common use areas of the building can be approached, entered, and used by individuals with physical handicaps. The phrase: "readily accessible to and usable by" is synonymous with accessible. See ANSI A117.1
- 2. Accessible route: a continuous unobstructed path connecting accessible elements and spaces in a building or within a site that can be negotiated by a person with a severe disability using a wheelchair, and that is also safe for and usable by people with other disabilities. Interior accessible routes may include corridors, floors, ramps, elevators and lifts. Exterior accessible routes may include parking access aisles, curb ramps, walks, ramps and lifts. See ANSI A117.1-1986; or part 5 of guidelines

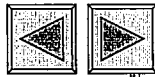

10/18/2005

3. Adaptable dwelling units: include features of adaptable design as specified in 24 CFR 100.205(c)(2)-(3)

4. Public entrance on an accessible route: an accessible entrance to a building that is connected by an accessible route to public transportation stops, to parking or passenger loading zones, or to public streets or sidewalks, if available.

5. Covered multifamily dwellings: building consisting of 4 or more dwelling units. Dwelling units within a single structure separated by firewalls do not constitute separate buildings

6. Ground floor: a floor of a building with a building entrance on an accessible route. A building may have one or more ground floors. Where the first floor containing a dwelling units in a building is above grade, all units on that floor must be served by a building entrance on an accessible route. This floor will be considered to be a ground floor.

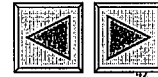

10/18/2005

2. Guidelines (7 Technical Guidelines) (Section 5)

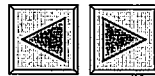

10/18/2005

1. Separate unit entrances: each served by accessible route

- 1. (100.205a) Covered multifamily dwellings shall be designed and constructed to have at least one entrance on an accessible route, unless it is impractical to do so because of terrain or unusual characteristics of the site
- 2. Multiple entrances: only one entrance required, but in the case of separate exterior entrances or clusters with each cluster sharing a different exterior entrance as determined by analysis

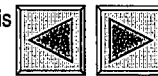

10/18/2005

2. (100.205c1) Accessible and usable public and common use areas

see "Basic Components for Accessible and Usable Public and Common Use Areas or Facilities"

On accessible routes, ANSI 4.13

10/18/2005

45

3.100.205c2) Usable doors

- ◆ Within individual dwellings, 32" clear with door at 90 degree angle see figure 1

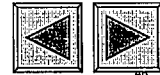

10/18/2005

46

4. (100.205c3j) Accessible route into and through the covered dwelling unit.

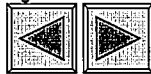

- ◆ 1. 36" min. clear width; Single story, elevation changes between 1/4 and 1/2" beveled; 1:2 slope max.
- ◆ 2. Except for design features(which cannot be on an accessible or egress path, loft, sunken room, changes in level over 12" are ramped or alternate means.
- ◆ A. In single family units with lofts, all spaces other than loft are on an accessible route
- ◆ B. Design features do not interrupt accessible route

10/18/2005

47

5.(100.205c3ii) Light switches, electrical outlets, thermostats and other environmental controls in accessible locations

- ◆ 1. Operable parts of the controls no higher than 48"; no lower than 15"
- ◆ 2. If reach over an obstruction between 20 and 25 inches in depth, the maximum height is reduced to 44 inches for forward approach, or 46 inches for side approach. (For example a kitchen base cabinet is no more than 24 inches in depth) Obstructions should not extend more than 25 inches.
- ◆ NOTE: controls that do not satisfy these specifications are acceptable provided that comparable controls or outlets are provided within the same area and are accessible

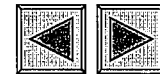

10/18/2005

48

6. (100.205c3) Reinforced walls for grab bars to allow later installation of grab bars around the toilet, tub, shower, stall and shower seat.

See figures 3, 4, 5. Where the toilet is not placed adjacent to a side wall, the bathroom would comply if provision was made for installation of floor mounted, fold away or similar alternative grab bars. Where the power room (a room with a toilet and sink) is the only toilet facility located on an accessible level of a multistory dwelling unit , it must comply with this requirement for reinforced walls for grab bars..... Reinforcement for grab bars may be provided in a variety of ways (for example by plywood or wood blocking) so long as the necessary reinforcement is placed so as to permit later installation of appropriate grab bars.

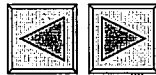

10/18/2005

7. (100.205c3iv) Usable kitchens and bathrooms:



10/18/2005

50

1. Usable Kitchens:

- A. Clear floor space 30" x 48" for a parallel approach to both range (or cook top) and sink and either a forward or a parallel approach is provided at oven, dishwasher, refrigerator/freezer or trash compactor (see figure 6)
- B. Clearance between counters and all opposing base cabinets, counter tops, appliances, or walls is at least 40"

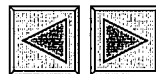

10/18/2005

C. In U shaped kitchens with sink or range (or cook top)

- at the base of the U, a 60 inch turning radius is provided to allow parallel approach, or base cabinets are removable at that location to allow knee space for a forward approach

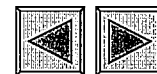

10/18/2005

Usable Bathrooms either :All bathrooms in unit comply with next option(B),
 or At least one bathroom complies with next option (B) and all other bathrooms must
 be on an accessible route with usable entry doors in accordance with requirements 3
 and 4. Where the power room (a room with a toilet and sink) is the only toilet facility
 located on an accessible level of a multistory dwelling unit , it must comply with this
 requirement for reinforced walls for grab bars.(100.205c3iv)

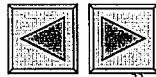

10/18/2005

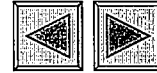

- A. Bathrooms that have reinforced walls for grab bars would meet section 100.205c3iv) if:
 - 1. Sufficient maneuvering space is provided within the bathroom for a person using a wheelchair or other mobility aid to enter and close the door, use the fixtures, reopen the door and exit. Doors may wing into the clear floor space provided at any fixture if the maneuvering space is provided. Maneuvering spaces may include any knee space or toe space available below bathroom fixtures
 - 2. clear floor spaces is provided at fixtures per figures 7a-d
 - 3. If the shower stall is the only bathing facility provided in the covered dwelling unit, the shower stall measures at least 36" x 36"

10/18/2005

54

B Bathrooms that have reinforced walls for grab bars

- 1. Where door swings in, there is a clear space,
 - (2' 6" x 4' 0") within the room to position a wheelchair or other mobility aid clear of the path of the door as it is closed and to permit use of fixtures. This clear space can include any knee space and toe space
 - 2. Where door swings out, clear space provided to use fixtures and reopen door

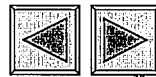

10/18/2005

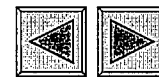

- 3. When both tub and shower fixtures are provided in the bathroom, at least one is made accessible. When two or more lavatories in a bathroom are provided, at least one is made accessible.
- 4. Toilets are located within bathrooms that permits a grab bar to be installed on one side of the fixtures. When adjacent, the center line of the fixture is a minimum of 1' 6" from obstacle. The other side is a min. of 1' 3" from finished surface of adjoining walls, vanities or from edge of a lavatory

10/18/2005

56

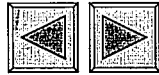

- 5. Vanities and lavatories are installed with the centerline of the fixture a minimum of 1' 3" horizontally from an adjoining wall or fixture. The top of the fixture rim is a max. 2'10" above finished floor. If knee space is provided below the vanity, the bottom of the apron is at least 2' 3" above the floor. If provided, full knee space (for front approach) is at least 1' 5" deep.
- 6. Bathtubs and tub/showers located in the bathroom provide a clear access aisle adjacent to the lavatory that is at least 2'6" wide and extends for a length of 4' 0" measured from the foot of the bathtub (figure 8)

10/18/2005

57

- 7. Stall showers may be on any size or configuration. A minimum clear floor space 2' 6" by 4'0" should be available outside the stall. If shower stall is the only bathing facility...and measures nominal 36" x 36", the shower stall must have reinforcing to allow for installation of an optional wall hung bench seat

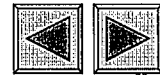

10/18/2005

Common Mistakes

- ◆ Parking not convenient
- ✓ Spaces in wrong locations
- ✓ Requires crossing lot to get to route
- ◆ Accessible routes to not lead throughout building to all common areas
- ✓ Common areas in Multifamily, multistory buildings not accessible
- ✓ If building has elevator, accessible route throughout building



10/18/2005

59

Did You know ...

- ◆ Local building official does not have authority to change requirements
- ◆ Fair housing act is a discrimination, not a building code issue



10/18/2005

60

Review: The 7 technical requirements?

- ◆ Entrance on accessible route
- ◆ Usable public and common areas
- ◆ Usable doors
- ◆ Accessible route into and through unit
- ◆ Usable Controls
- ◆ Reinforced walls, grab bars
- ◆ Usable kitchen and baths

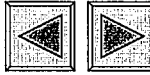

10/18/2005

61

How to use the tabs

- Special exhibit has left and right hand column
- Left hand column represents pages upon which to place tabs,
- Right hand section gives rationale
- Start at top of 1st page, place tab, come down a notch and place next tab on next applicable page.

Florida Dept. of
Community Affairs
1-850-487-1824

Links:
MyFlorida
DCA
HUD



10/18/2005

62

Does he/she Pass the Test ?

- ◆ An access corridor is accessible through the service entrance of the building. If this is a covered building, will this meet the first technical requirement ?

No, accessible must not be through service area unless this is only entrance to building



10/18/2005

63

Chapter 11, Florida Building Code

1 ADA / ANSI

- 1. Background
- 2. ANSI - Federal Standards
 - a. Maximum slope 1:12; maximum rise for run not exceed 2'6"
 - b. Total Parking (Table 1104.3-172)
 - c. Passenger loading min. 60"
 - d. Accessible Route (1103-171)
 - e. Alarm Systems (1109 - 175)

2. Florida Accessibility Code (FLAAC)

- 1. Minimum Requirements and Definitions 11-4.1
 - a. New Construction
 - b. Additions 11. 4.1.5
 - c. Alterations 11. 4.1.5
 - 1. Up to 20% rule
 - 2. "Undue Hardship"
 - d. Egress
 - e. Accessible Route
- 2. Min. One Accessible Route 11.4.2.1(1)
- 3. Parking Table 4.2.1(5)
- 4. Telephones Provided 11.4.1.3(17)(a)
- 5. New Construction 11.4.1.3
- 6. Doors 32" clear span 11. 4.1.3(7)
- 7. Technically Infeasible 11.4.1.6(j)
- 8. Parking and passenger loading zones (11.4.6)
- 9. Ramps (11-4.8)
- 10 Stairs (11.4.9)
- 11. Elevators (11.4.10)
- 12. Doors (11.4.13)
- 13. Entrances (11.4.14)
- 14. Clear Floor or Ground Space for Wheelchairs 11. 4.2.4
- 15. Accessible route/slope 11. 4.3.7
- 16. Area of Rescue Assistance 11. 4.3.11.2
- 17. Parking and Passenger Loading zones 11.4.6.1
- 18. Curb ramps 11.4.7.1
- 19. Ramps 11.4.8.1
- 20. Thresholds at Doorways 11.4.13.8
- 21. Water Closets 11.4.16
- 22. Toilet Stalls 11. 4.17
- 23. Bathtubs (11.4.20)
- 24. Toilet rooms (11.4.22)
- 25. Handrails, Grab bars and Tub/Shower Seats (11.4.26)
- 26. Controls and Operating Mechanisms (11.4.27)
- 27. Clear Floor Space 11. 4.23.3
- 28. Alarms 11.4.28
- 29 Detectable Warnings (11.4.29)
- 30. Restaurants and Cafeterias (11.6)
- 31 Business and Mercantile (11-7)
- 32. 19. Diagrams, exhibits 11.51
- 33. Florida Administrative code Chapter 9B-7 Waiver procedures . . 9b-7.003

3. Fair Housing Accessibility Guidelines (Part B, Chapter 11, HUD)

1. Definitions

1. Accessible : When used in context of public and common use areas of a building containing covered multifamily dwellings means that the public or common use areas of the building can be approached, entered, and used by individuals with physical handicaps. The phrase: "readily accessible to and usable by" is synonymous with accessible. See ANSI A117.1

2. Accessible route : a continuous unobstructed path connecting accessible elements and spaces in a building or within a site that can be negotiated by a person with a severe disability using a wheelchair, and that is also safe for and usable by people with other disabilities. Interior accessible routes may include corridors, floors, ramps, elevators and lifts. Exterior accessible routes may include parking access aisles, curb ramps, walks, ramps and lifts. See ANSI A117.1-1986; or part 5 of guidelines

3. Adaptable dwelling units : include features of adaptable design as specified in 24 CFR 100.205(c)(2)-(3)

4. Public entrance on an accessible route: an accessible entrance to a building that is connected by an accessible route to public transportation stops, to parking or passenger loading zones, or to public streets or sidewalks, if available.

5. Covered multifamily dwellings: building consisting of 4 or more dwelling units. Dwelling units within a single structure separated by firewalls do not constitute separate buildings

6. Ground floor : a floor of a building with a building entrance on an accessible route. A building may have one or more ground floors. Where the first floor containing a dwelling units in a building is above grade, all units on that floor must be served by a building entrance on an accessible route. This floor will be considered to be a ground floor.

2. Guidelines (7 Technical Guidelines) (Section 5)

1. (100.205a) Covered multifamily dwellings shall be designed and constructed to have at least one entrance on an accessible route, unless it is impractical to do so because of terrain or unusual characteristics of the site

1. Separate unit entrances: each served by accessible route

2. Multiple entrances: only one entrance required, but in the case of separate exterior entrances or clusters with each cluster sharing a different exterior entrance as determined by analysis of site

2. (100.205c1) Accessible and usable public and common use areas see "Basic Components for Accessible and Usable Public and Common Use Areas or Facilities"

3.100.205c2) Usable doors

1. On accessible routes, ANSI 4.13

2. Within individual dwellings, 32" clear with door at 90

- angle see figure 1
4. (100.205c3j) Accessible route into and through the covered dwelling unit.
 1. 36" min. clear width; Single story, elevation changes between 1/4 and 1/2" beveled; 1:2 slope max.
 2. Except for design features(which cannot be on an accessible or egress path, loft, sunken room, changes in level over 12" are ramped or alternate means.
 - A. In single family units with lofts, all spaces other than loft are on an accessible route
 - B. Design features do not interrupt accessible route
 3. In multistory buildings with elevators, the story of the unit is served by elevator
 - A. Primary entry to unit
 - B. Complies with 2-7 with respect to the rooms located on the entry/accessible floor
 - C. Contains a bathroom or powder room which complies with Requirement 7. Note: Multistory dwelling units in non-elevator buildings are not covered dwelling units because , in such cases, there is no ground floor unit
 4. Except as proved in 5 & ^ thresholds at exterior doors, including sliding door tracks, are no higher than 3/4 inch. Thresholds and changes in level at these locations are beveled slope, 2:1 max.
 5. Exterior deck, patio, or balcony surfaces are no more than 1/2 " below the floor level of the interior; unless constructed of impervious material such as concrete. In this case, no more than 4"
 6. Entry door with direct exterior access, outside landing surfaces constructed of impervious materials are no more than 1/2 inch below the floor level of the interior. The finished surface of the area that is located immediately outside the entry may be sloped, up to 1/8" per ft. (12") for drainage.
 - 5.(100.205c3ii) Light switches, electrical outlets, thermostats and other environmental controls in accessible locations
 1. Operable parts of the controls no higher than 48"; no lower than 15"
 2. If reach over an obstruction between 20 and 25 inches in depth, the maximum height is reduced to 44 inches for forward approach, or 46 inches for side approach. (For example a kitchen base cabinet is no more than 24 inches in depth) Obstructions should not extend more than 25 inches.
NOTE: controls that do not satisfy these specifications are acceptable provided that comparable controls or outlets are provided within the same area and are accessible
 6. (100.205c3) Reinforced walls for grab bars to allow later installation of grab bars around the toilet, tub, shower, stall and shower seat. See figures 3, 4, 5. Where the toilet is not placed adjacent to a side wall, the bathroom would comply if provision was made for installation of floor mounted, fold away or similar alternative grab bars. Where the power room (a room with a toilet and sink) is the only toilet facility located on an accessible level of a multistory

dwelling unit , it must comply with this requirement for reinforced walls for grab bars..... Reinforcement for grab bars may be provided in a variety of ways (for example by plywood or wood blocking) so long as the necessary reinforcement is placed so as to permit later installation of appropriate grab bars.

7. (100.205c3iv) Usable kitchens and bathrooms:

1. Usable Kitchens:

A. Clear floor space 30" x 48" for a parallel approach to both range (or cook top) and sink and either a forward or a parallel approach is provided at oven, dishwasher, refrigerator/freezer or trash compactor (see figure 6)

B. Clearance between counters and all opposing base cabinets, counter tops, appliances, or walls is at least 40"

C. In U shaped kitchens with sink or range (or cook top) at the base of the U, a 60 inch turning radius is provided to allow parallel approach, or base cabinets are removable at that location to allow knee space for a forward approach

2. Usable Bathrooms either :All bathrooms in unit comply with next option(B), or At least one bathroom complies with next option (B) and all other bathrooms must be on an accessible route with usable entry doors in accordance with requirements 3 and 4. Where the power room (a room with a toilet and sink) is the only toilet facility located on an accessible level of a multistory dwelling unit , it must comply with this requirement for reinforced walls for grab bars.(100.205c3iv)

A. Bathrooms that have reinforced walls for grab bars would meet section 100.205c3iv) if:

1. Sufficient maneuvering space is provided within the bathroom for a person using a wheelchair or other mobility aid to enter and close the door, use the fixtures, reopen the door and exit. Doors may swing into the clear floor space provided at any fixture if the maneuvering space is provided. Maneuvering spaces may include any knee space or toe space available below bathroom fixtures

2. clear floor spaces is provided at fixtures per figures 7a-d

3. If the shower stall is the only bathing facility provided in the covered dwelling unit, the shower stall measures at least 36" x 36"

B Bathrooms that have reinforced walls for grab bars

1. Where door swings in, there is a clear space,

(2' 6" x 4' 0") within the room to position a wheelchair or other mobility aid clear of the path of the door as it is closed and to permit use of fixtures. This clear space can include

any knee space and toe space

2. Where door swings out, clear space provided

to use fixtures and reopen door

3. When both tub and shower fixtures are provided in the bathroom, at least one is made accessible. When two or more lavatories in a bathroom are provided, at least one is made accessible.

4. Toilets are located within bathrooms that permits a grab bar to be installed on one side of the fixtures. When adjacent, the center line of the fixture is a minimum of 1' 6" from obstacle. The other side is a min. of 1' 3" from finished surface of adjoining walls, vanities or from edge of a lavatory

5. Vanities and lavatories are installed with the centerline of the fixture a minimum of 1' 3" horizontally from an adjoining wall or fixture. The top of the fixture rim is a max. 2'10" above finished floor. If knee space is provided below the vanity, the bottom of the apron is at least 2' 3" above the floor. If provided, full knee

space (for front approach) is at least 1' 5" deep.

6. Bathtubs and tub/showers located in the bathroom provide a clear access aisle adjacent to the lavatory that is at least 2'6" wide and extends for a length of 4' 0" measured from the foot of the bathtub (figure 8)

7. Stall showers may be on any size or configuration. A minimum clear floor space 2' 6" by 4'0" should be available outside the stall. If shower stall is the only bathing facility...and measures nominal 36" x 36", the shower stall must have reinforcing to allow for installation of an optional wall hung bench seat

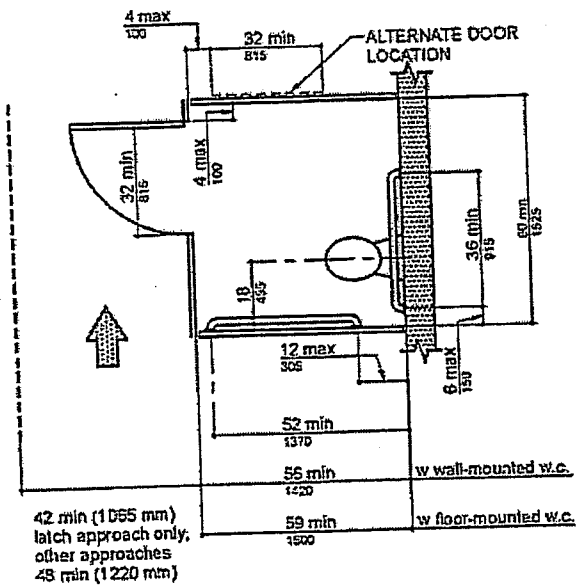

(a)
Standard Stall

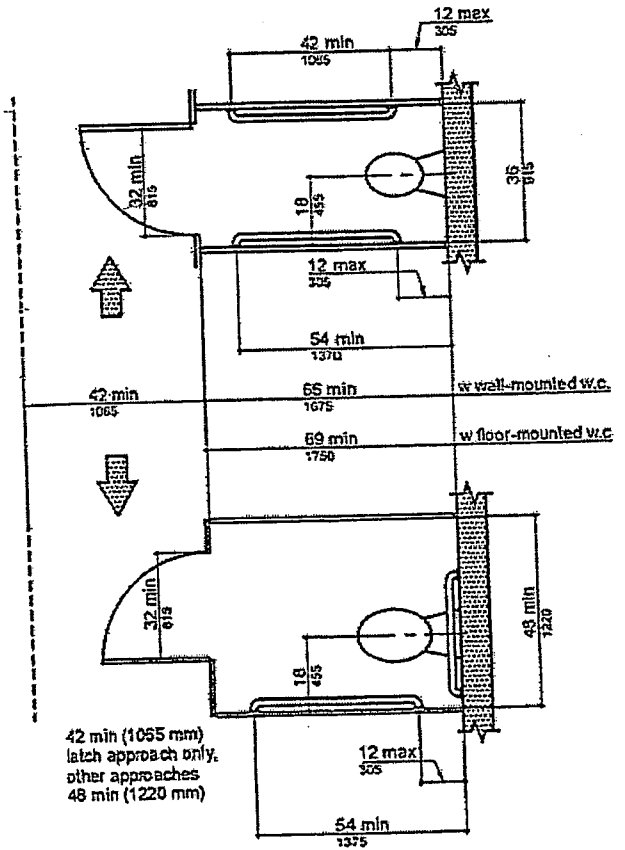

(b)
Alternate Stalls

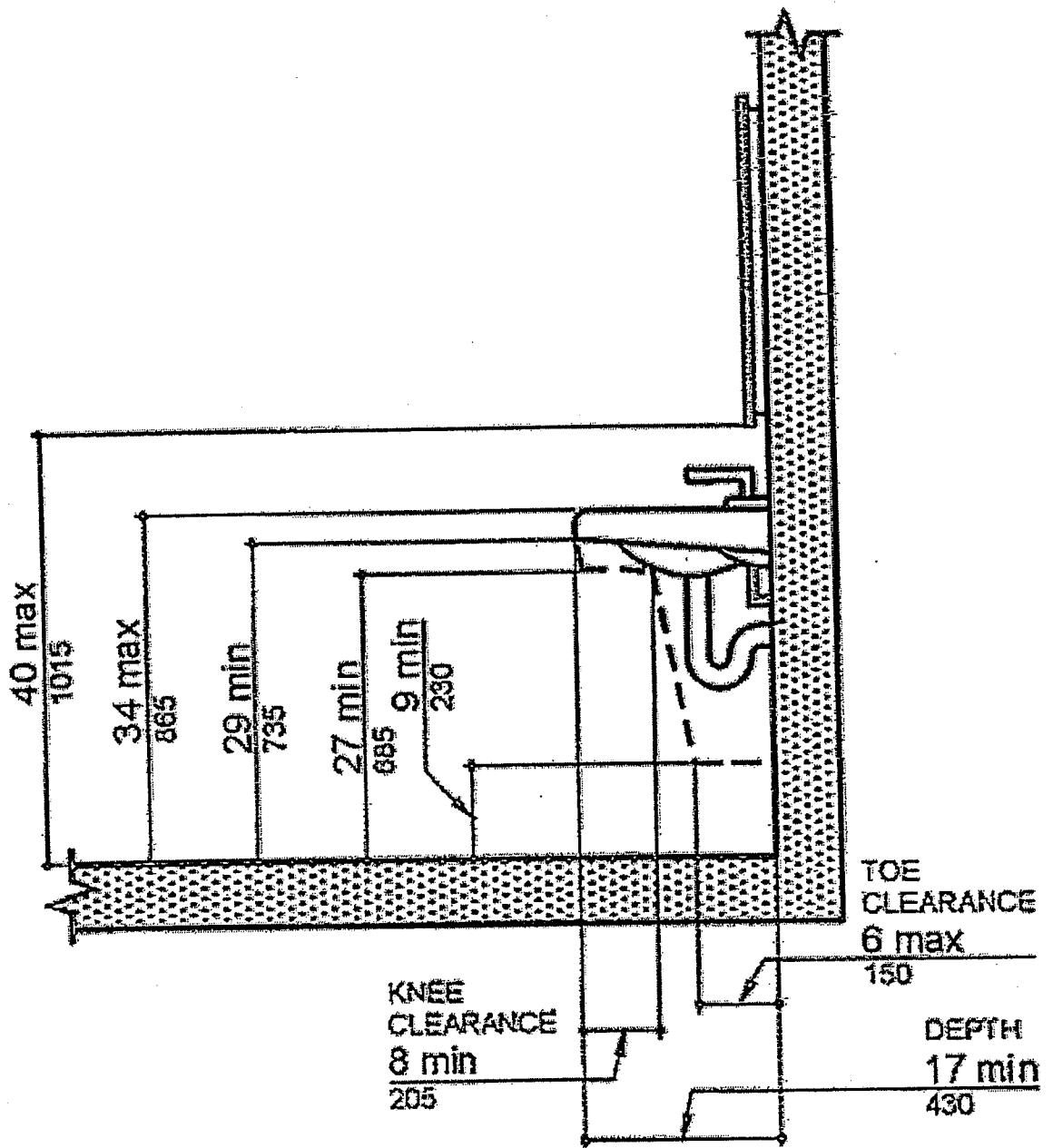

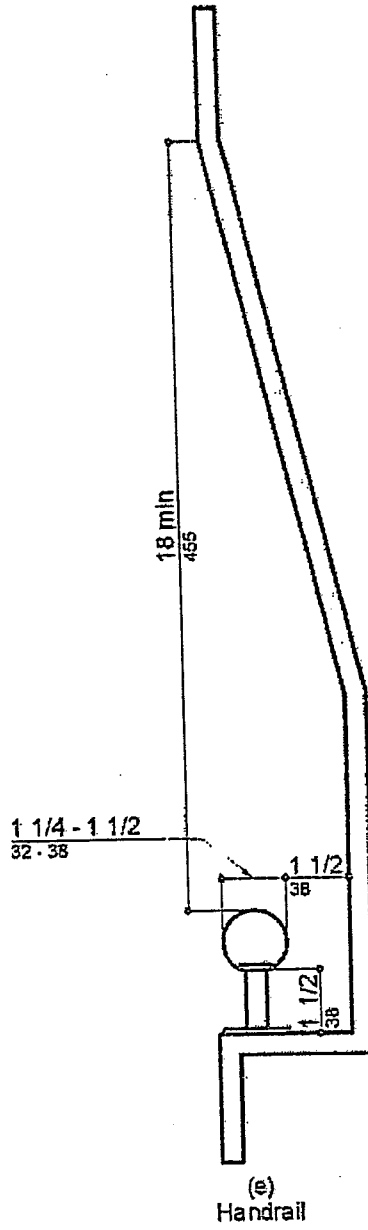
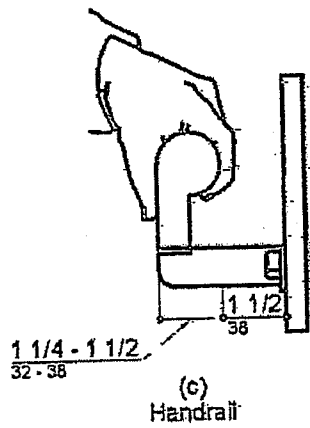

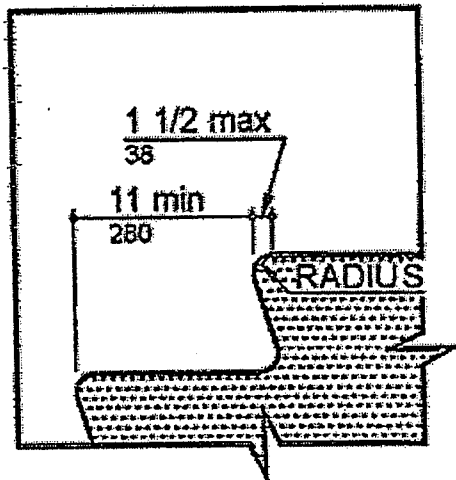

(a)
Flush Riser

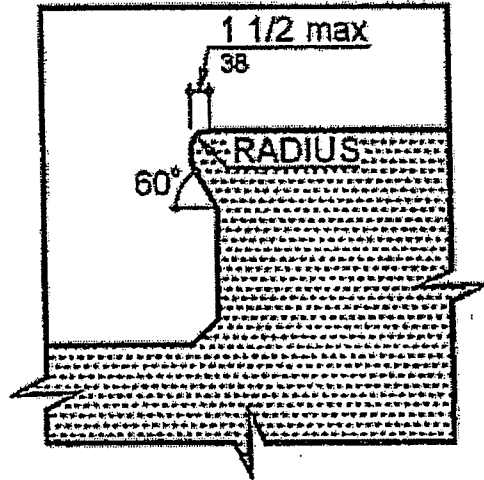

(b)
Angled Nosing

FIGURE 18
USABLE TREAD WIDTH AND EXAMPLES OF ACCEPTABLE NOSINGS

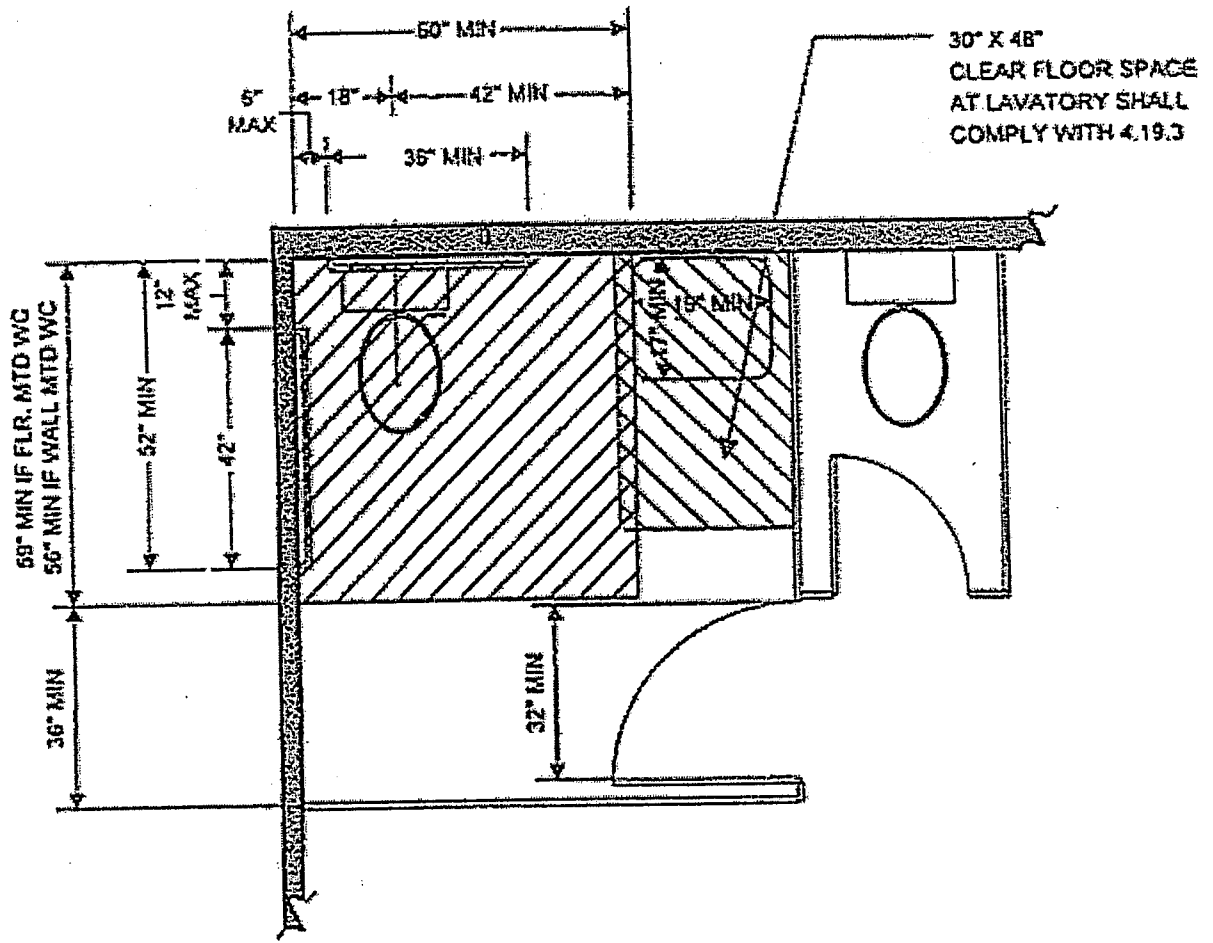
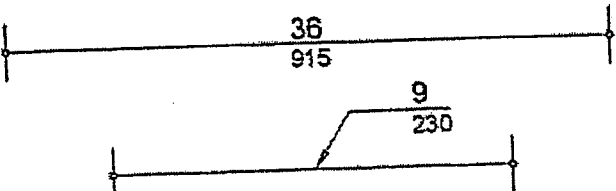
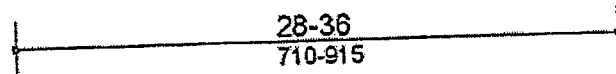



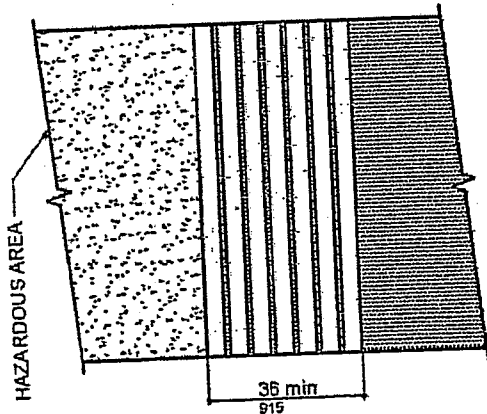
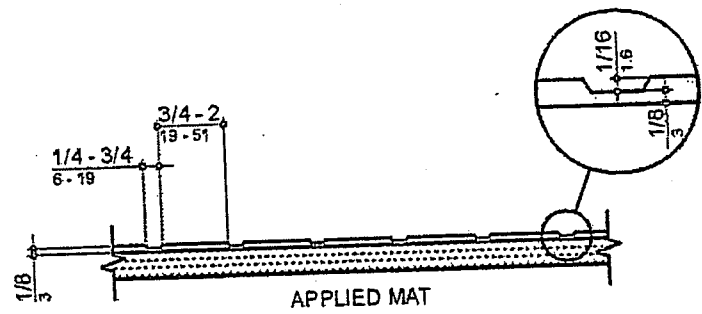
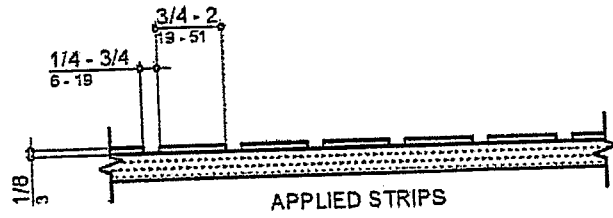

Table 1
Graphic Conventions

| Convention | Description |
|---|--|
|  | <p>Typical dimension line showing U.S. customary units (in inches) above the line and SI units (in millimeters) below.</p> <p>Dimensions for short distances indicated on arrow.</p> |
|  | <p>Dimensions line for showing range of dimension</p> |
|  | <p>Direction of approach</p> |
| <p>max</p> | <p>Maximum</p> |
| <p>min</p> | <p>Minimum</p> |
|  | <p>Boundary of clear floor area</p> |
|  | <p>CL Centerline</p> |



(a) Plan of Detectable Warning Surface



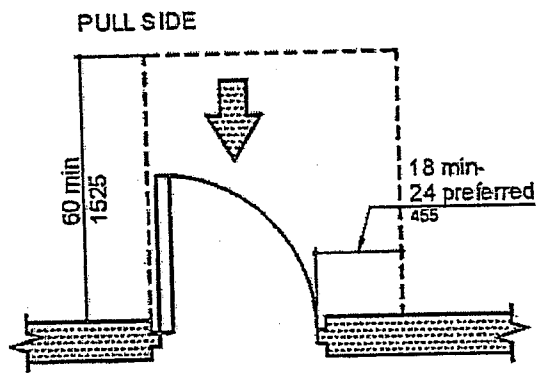

(a)
Front Approaches - Swinging Doors

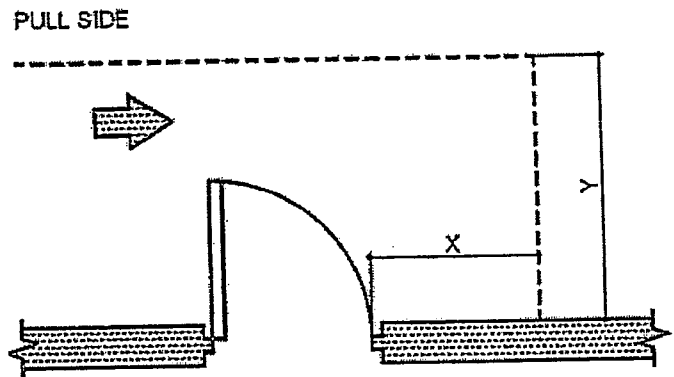

NOTE: X=36 in. (915 mm) minimum
 if Y = 60 in. (1525 mm); X=42 in. (1065 mm)
 minimum if Y=54 in. (1370 mm)

(b)
Hinge-side Approaches - Swinging Doors

NOTE: All doors in alcoves shall comply with
 the clearances for front approaches.

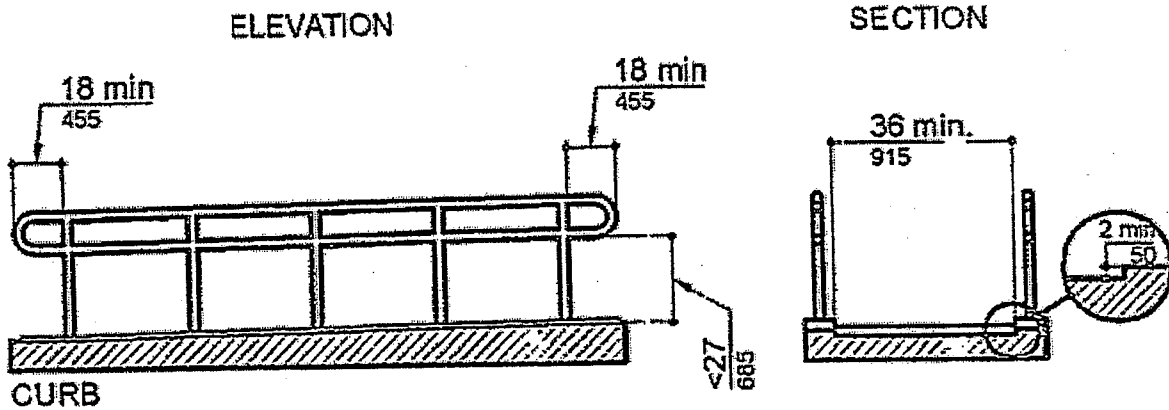
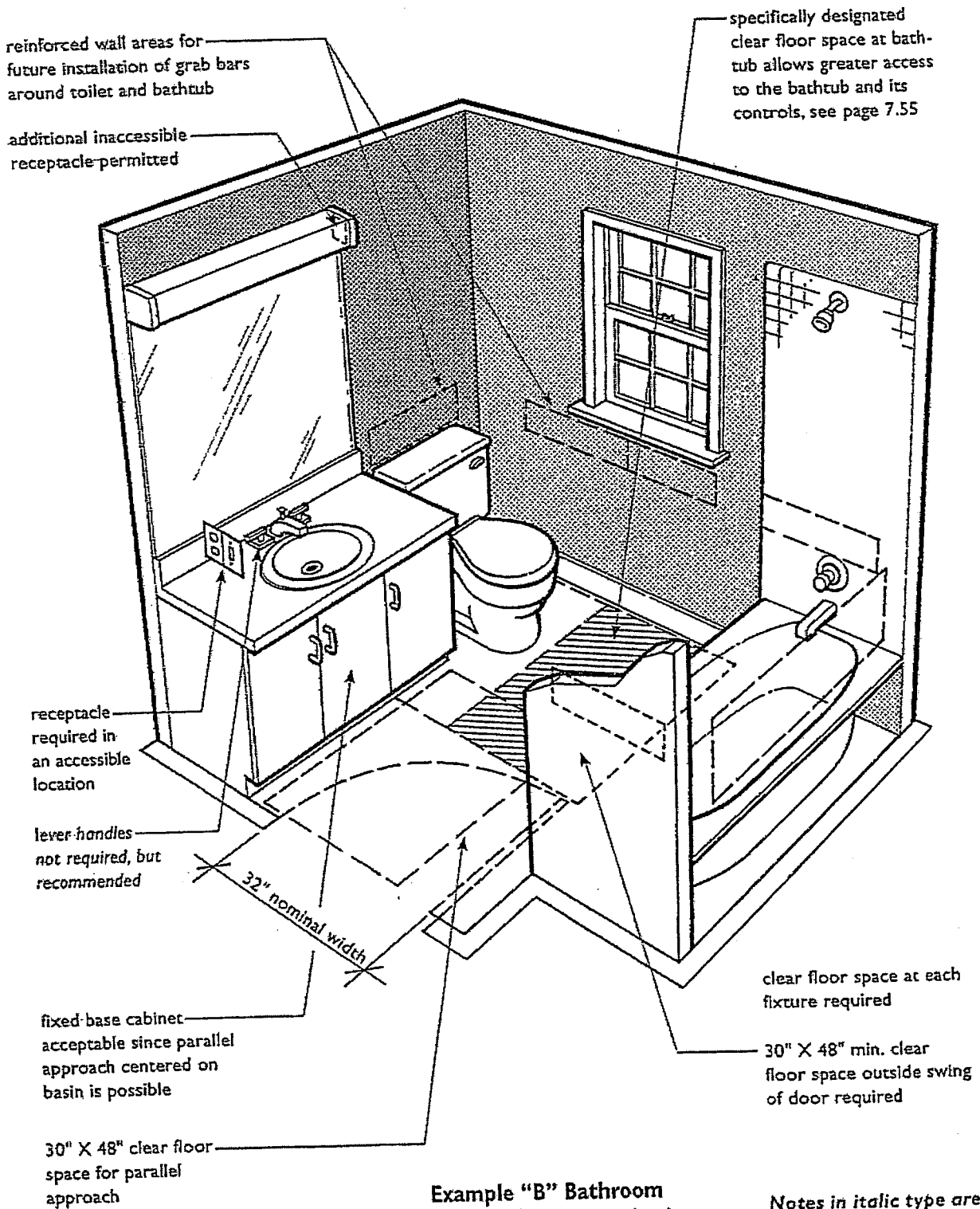

FIGURE 17
EXAMPLES OF EDGE PROTECTION AND HANDRAIL EXTENSIONS

USABLE KITCHENS AND BATHROOMS ■ PART B: USABLE BATHROOMS



Example "B" Bathroom
Greater Access to Bathtub
6'-10" X 7'-9"
 (Similar to Plan on Page 7.67)

Notes in italic type are recommendations only and are not required by the Guidelines.

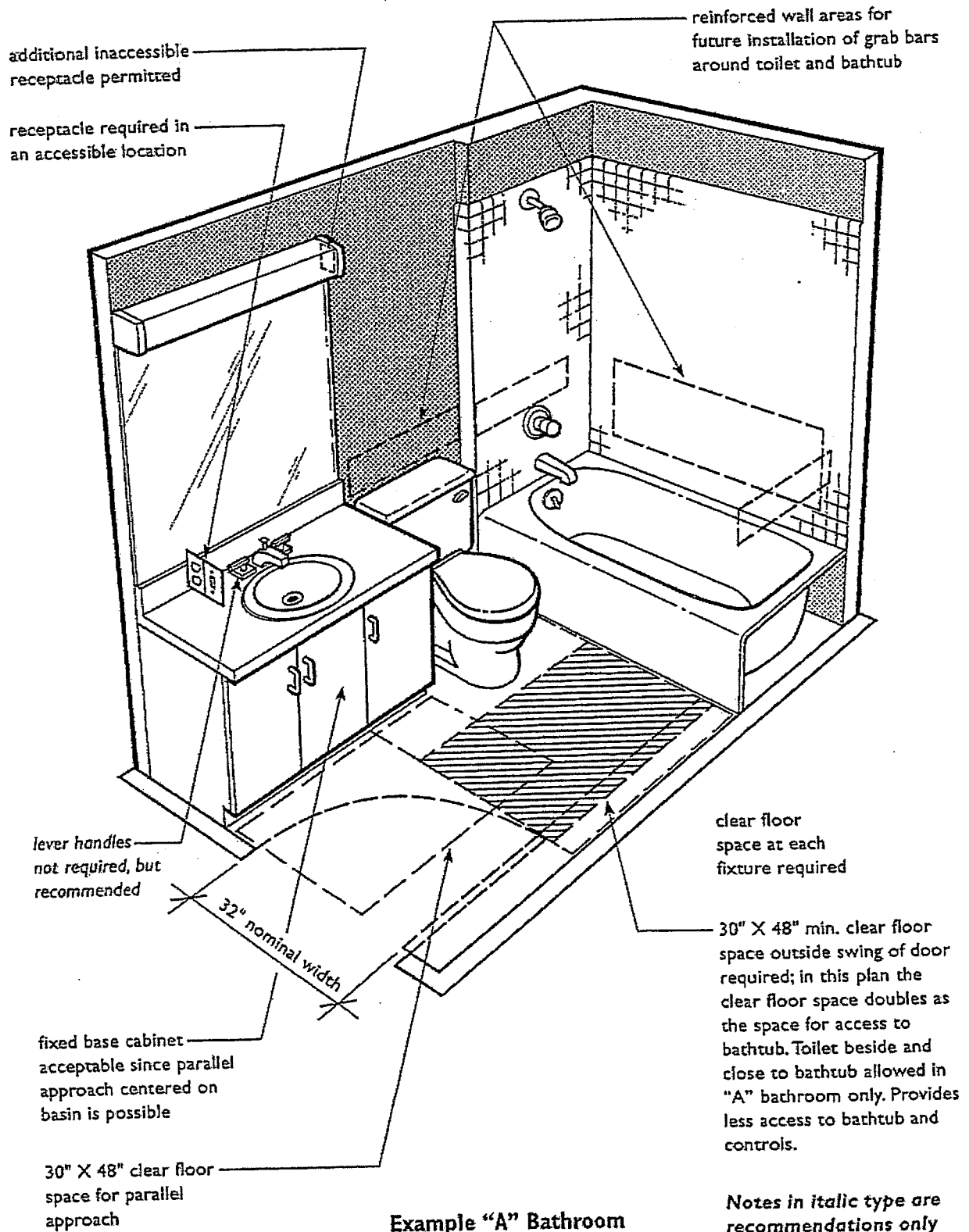

Example "A" Bathroom
 9'-4" X 5'-2"
 (See plan page 7.66)

Notes in italic type are recommendations only and are not required by the Guidelines.

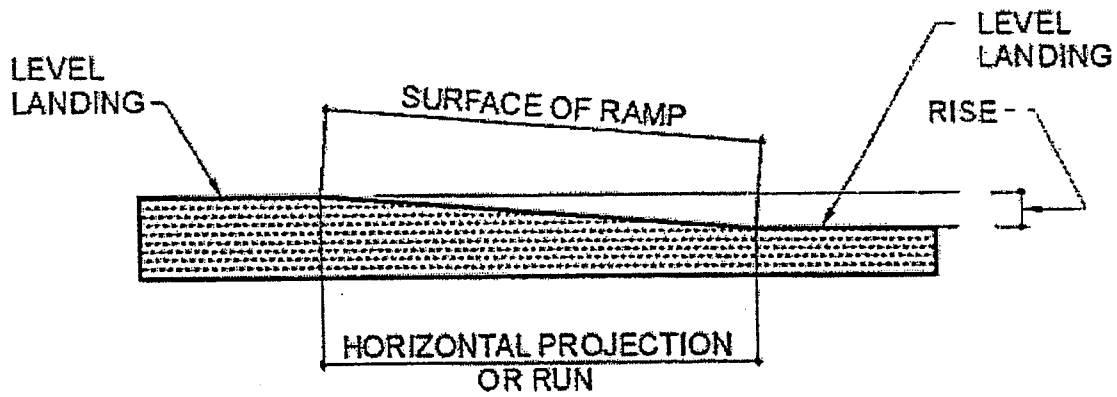

| Slope | Maximum Rise | | Maximum Horizontal Projection | |
|----------------|--------------|-----|-------------------------------|----|
| | in. | mm | ft | m |
| 1:12 to < 1:16 | 30 | 760 | 30 | 9 |
| 1:16 to < 1:20 | 30 | 760 | 40 | 12 |

FIGURE 16
COMPONENTS OF A SINGLE RAMP RUN AND SAMPLE RAMP DIMENSIONS

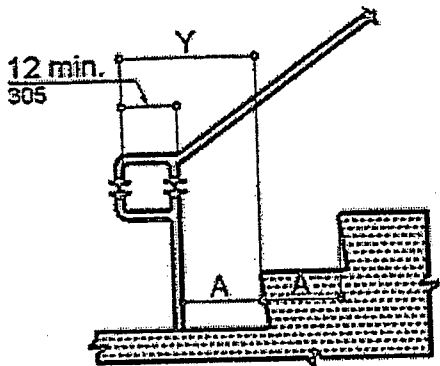

(c)
Extension at
Bottom of Run

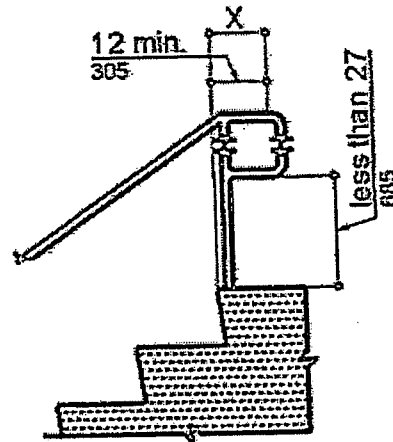

(d)
Extension at
Top of Run

NOTE: X IS THE 12 IN. MINIMUM HANDRAIL EXTENSION
REQUIRED AT EACH TOP RISER

Y IS THE MINIMUM HANDRAIL EXTENSION OF 12 IN.
PLUS THE WIDTH OF ONE TREAD THAT IS
REQUIRED AT EACH BOTTOM RISER.