

# SYSTEM #1

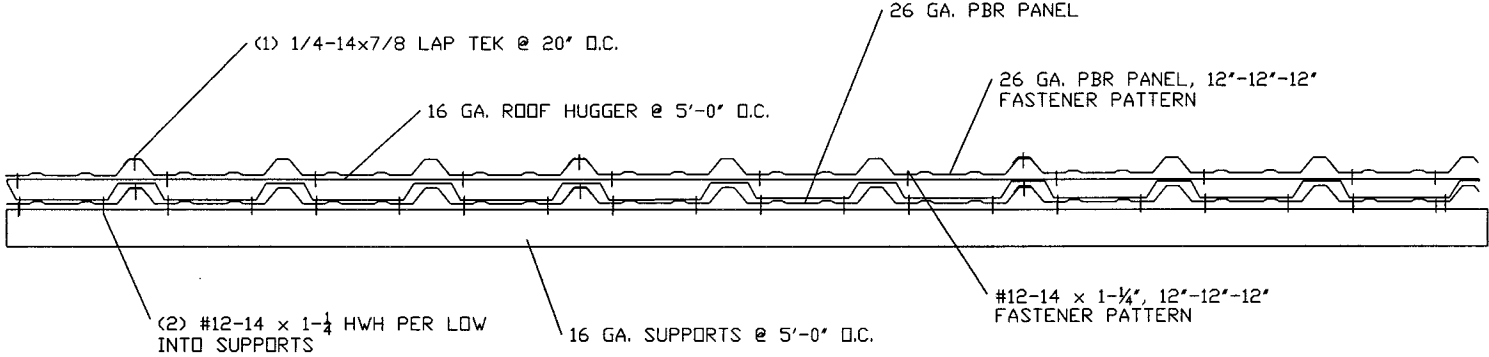

# SYSTEM #2

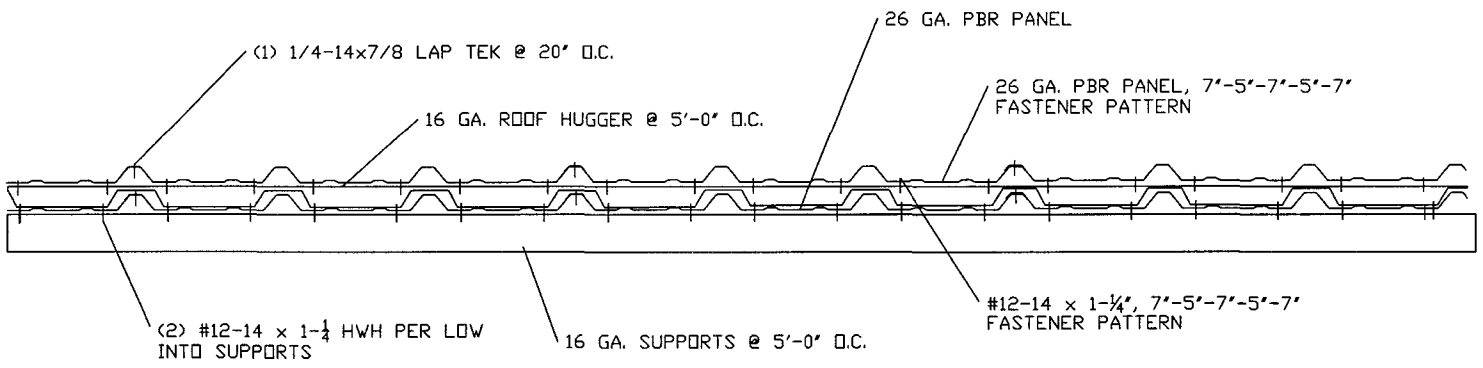

SYSTEM #3  
HATS @ 24" O.C.  
SECTION A-A @ SUPPORT

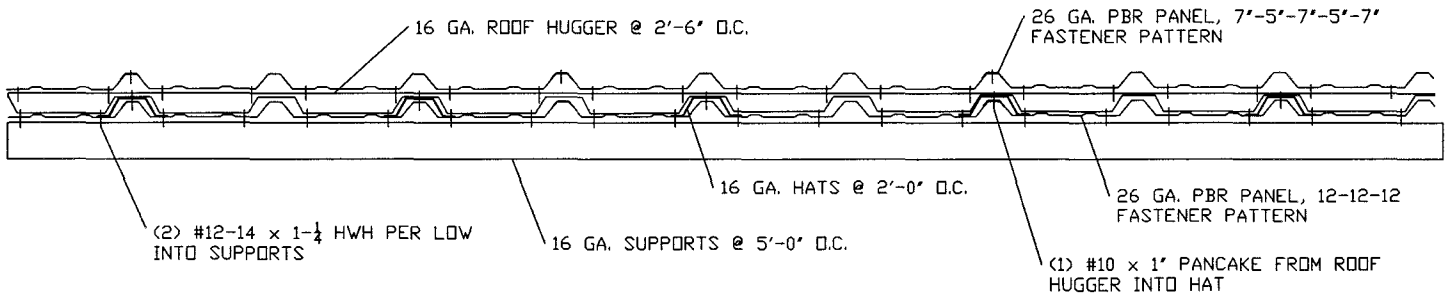

SECTION B-B @ MIDSPAN

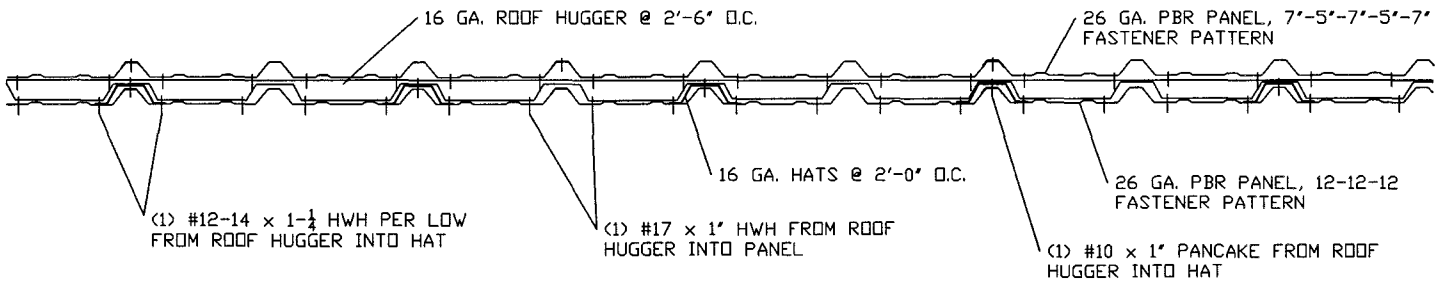

# SYSTEM #4

## HATS @ 12" O.C.

### SECTION A-A @ SUPPORT

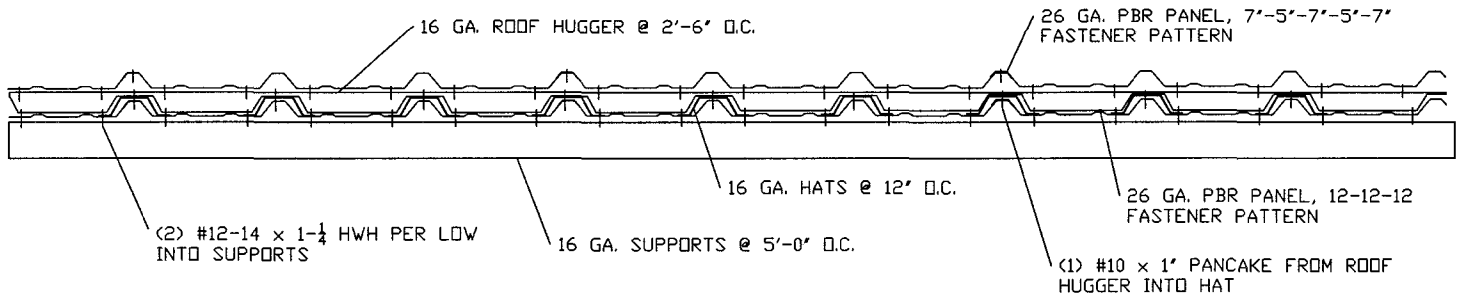

### SECTION B-B @ MIDSPAN

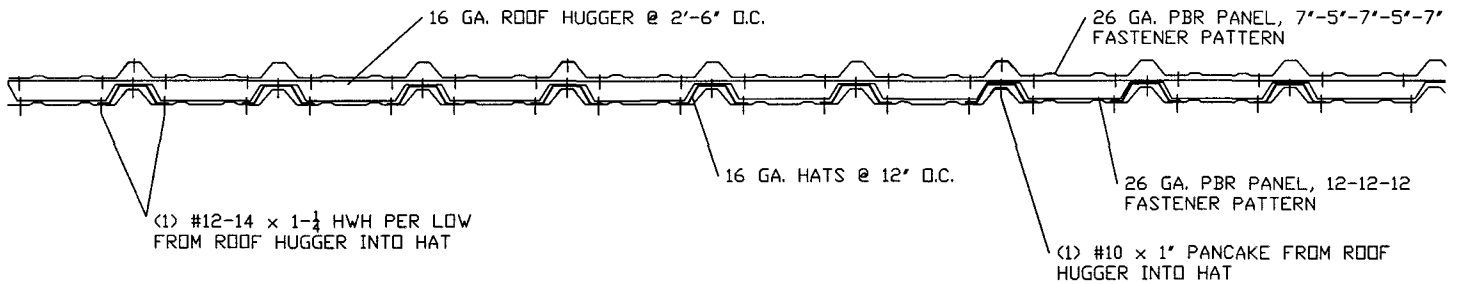

"TYPICAL"  
"PBR" PANEL

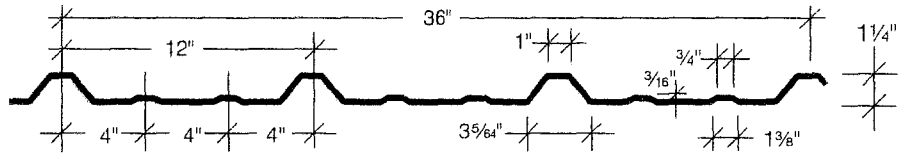

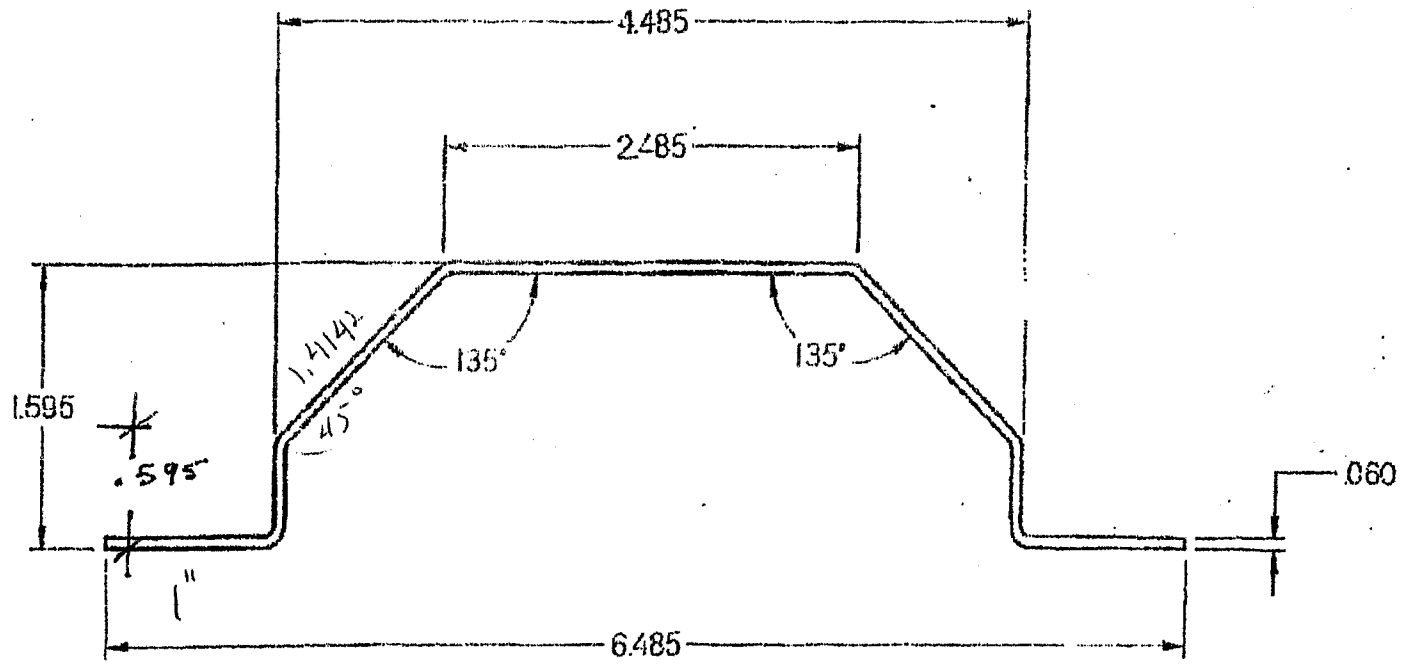

**TOLERANCES**  
 Unless otherwise specified dimensions are in inches.  
 Fractional ± 1/54 Holes +.001 +.002 Angles ± 3°  
 Decimals .X ± .060 .XX ± .030 .XXX ± .015



1402 West Kennedy Boulevard, Tampa, FL 33616  
 Phone (813) 251-2445 Fax (813) 254-7399  
 On the Web - <http://www.tampamet.com>

Job No	Error: No reference	Stored	DATAJOB53
Cost	Error: No reference	PO No	
Dwg No	Error: No reference	Date	10/16/2006
Title	Error: No reference	Created	10/16/2006 Sheet 3 of 6
Drawn	Error: No reference	Checked	
		Rev. Error No	1

# Our Patented Design is Simple, Strong - Effective!

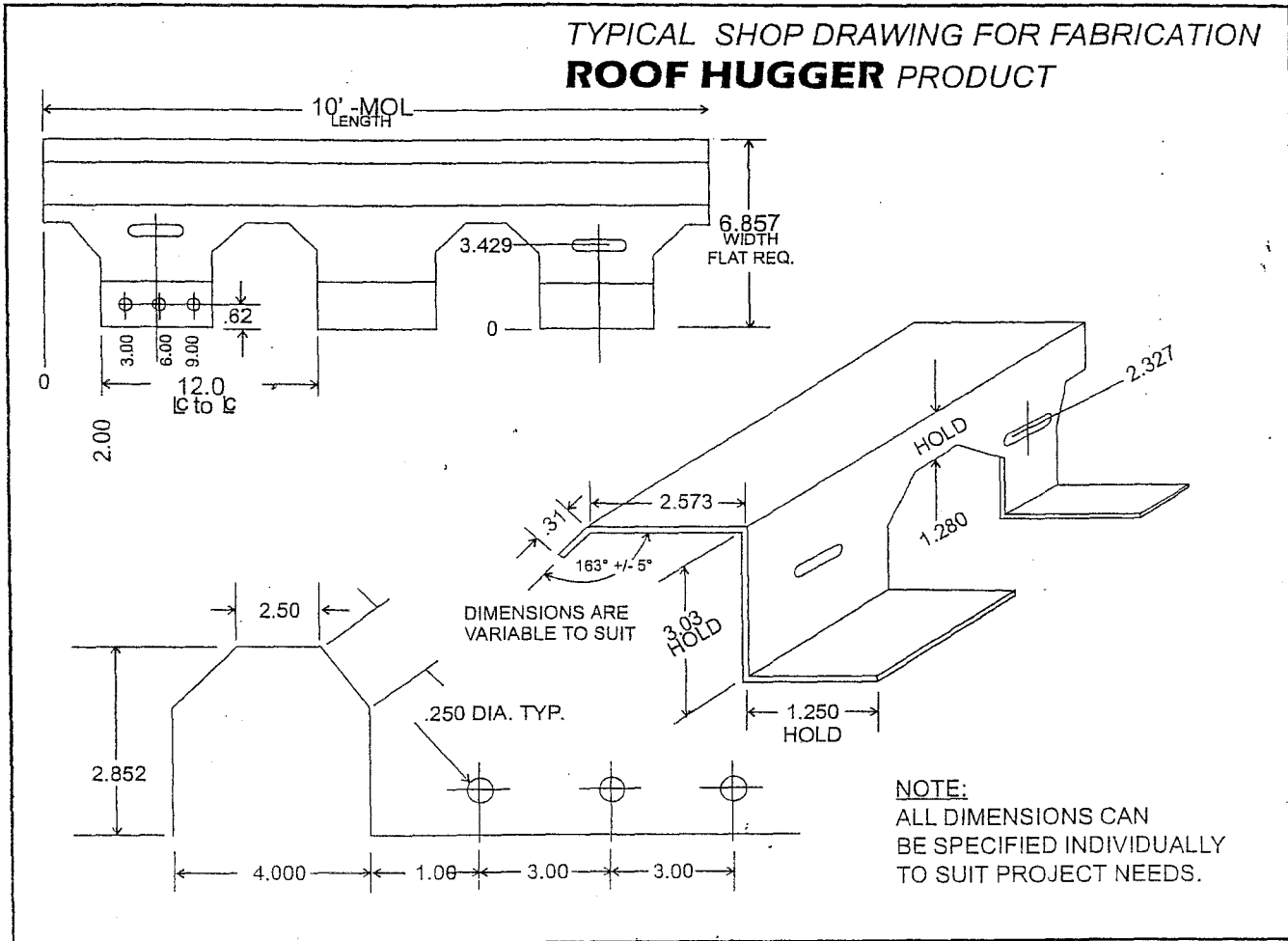

## A Partial Sampling of Available Hugger Profiles

Vertical Standing Seam 12" - 24"

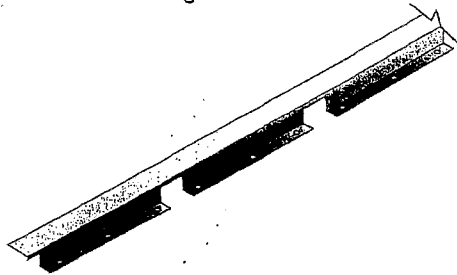

6" - 10" o.c. Special Cutout

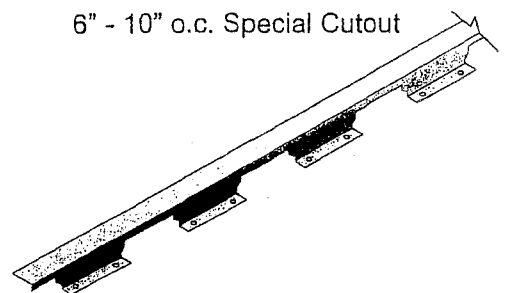

2.67" - 4.2" Corrugated

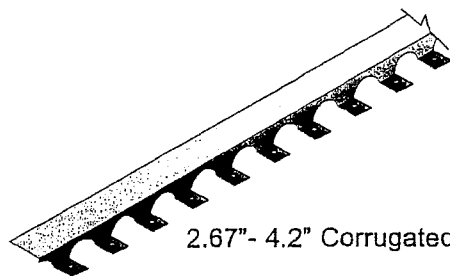

All profiles produced in +/- 10' lengths.

Hugger with Major and  
Minor-Rib Cutout

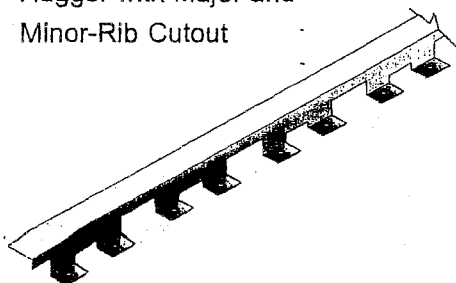

12" o.c. - 1'-1" R-Panel

