

FILED
Department of Business and Professional Regulation
Deputy Agency Clerk
CLERK Brandon Nichols
Date **6/18/2013**
File #

DS 2013-048

**PETITION FOR DECLARATORY STATEMENT
BEFORE THE FLORIDA DEPARTMENT BUILDING COMMISSION**

IN THE MATTER OF:

James Stolz, Affected Party/Petitioner **CASE No:** _____

Petitioner / Affected Party:

James Stolz
4897 Quail Valley Road
Tallahassee, Florida 32309
(850) 567-2797
jimstolz@centurylink.net

Statutes, and or Code Sections in which the Declaratory Statement is Sought:

Florida Building Code 2010
Occupancy Classification, Section 310 and
Section 7 Fire Separation Area Distance requirements, AND
FBC Residential 2010, occupancy classification misapplication and
Section R302 Fire Separation Area Distance requirements.

Attorney Involved: None

Summary of Issue: An Engineer of Record has submitted plans for a ten unit three bedroom multifamily student Campus Block FSU apartment complex all on a single lot in Tallahassee. The applicant has made claim that these ten three story units are residential units that contain three bedrooms and a study hall with each of those rooms equipped with a privacy door, a private bath and a walk in closet. November 30, 2012, the Development Review Committee Site Plan Fire Review stated that the project was not exempt from *Florida Law F.S. 533.895(2)*. December 19, 2012, the applicant stated that three bedroom three story units are an exception under the Florida Code that does not require fire sprinklers as required by *Florida Law F.S. 533.895(2)*.

The applicant then made claim that the ten units are a combination of single and two family residential units and residential dwelling units therefore they do not require sprinklers nor certification by an Architect under FS 481. The applicant then submitted

individual construction plans for four two family units and two single family units located on a single parcel under the Florida Residential Code Review with a master site plan showing all ten units on the single parcel. Under the Florida Residential Code, a Fire Review was no longer required for Campus Block. After the residential building permits were issued, the applicant then requested that the DRC approve Campus Block for ten multifamily apartment units at four bedrooms each unit. Ten multifamily units on one single lot does not meet the any Florida Building Code definition to be classified as single family residential and two family residential units. Permits lawfully should have been classified under the R-2 Apartment occupancy category of the Florida Building Code. Florida Department Board of Professional Regulation has investigated and issued their findings and have been attached.

March 1, 2013 Campus Block building permits were requested and issued under the *FBC 2010 Residential Code*, not the *Florida Building Code 2010 Section 310 Residential Group R, R-2* occupancy in which includes; *more than two dwelling units where occupants are primarily permanent in nature, including apartments*. Residential building permits were issued for all ten units of the apartment complex as four two family units and two single family residential three bedroom with study hall light frame wood truss vented soffit units all situated on a single lot under the Florida Residential Code without any required Fire Review nor any Architect (FS 481) signed and sealed construction documents.

Foundations have been poured and the multifamily units are separated by a horizontal distance of five feet. The Fire Separation Distance between units with the siding added is four feet ten inches. April 8, 2013 the Campus Block re-application has received a site plan approval modification to increase the ten - three bedroom units to ten - four bedroom multifamily apartments. The floor plans remained the same, the study hall was relabeled as the fourth bedroom. Each four bedroom unit has a bedroom on the third floor with a secondary means of egress window and there are multiple habitable space windows on the common walls in the Fire Separation Area between the units with a FBC defined two feet five inches Fire Separation Distance.

The Florida Residential Code states that a minimum of a three foot separation to the property line is required for a six foot separation between units on dwellings if units were on individual lots. As per the applicant, this parcel has a publicly recorded under a *unity of title* instrument and is a single lot with 10 multifamily apartment units.

As per *Florida Building Code Table 705.8* or for that matter, as per *FBC Residential Fire Section R302*, the *Maximum area of exterior wall openings based on fire separation and degree of opening protection*, any distance of less than 3 feet separation, any allowable opening area in any degree of opening protection is NOT PERMITTED.

Light frame type V B construction with wood trusses, vented one foot soffit roof projections, exterior mounted gas fuel fired 199,000 BTUH water heaters and unprotected openings exist in these Fire Separation Areas. Regardless of which Code is used, any allowable opening area in any degree of opening protection in these Fire Separation Areas is NOT ALLOWED. Further:

FBC R Table R302.1 Fire Resistance Rating Requirements for exterior bearing walls (without any openings), based on a fire separation distance of less than three feet require that the exterior wall have a one hour fire rating. The Campus Block exterior walls are not fire rated.

FBC R302.6 The Campus Block Apartments exterior bearing walls in the Code defined fire separation areas are two foot five inch Fire Separation Distance and the garage exterior walls are not properly fire rated.

I am the adjacent property owner and any attic fire in the adjacent thirty-six foot tall apartments could cause a collapse of burning debris on my occupied single level unit twenty two feet away without any advanced warning. The Building Official has been made aware of the Code discrepancies and the issues are posted in the public record under the City of Tallahassee, three bedroom Residential Building Permits TBB 130329, TBB 130330, TBB 130331, TBB 130332, TBB 130333, and TBB 130334.

The EOR has subsequently requested and received a modified site plan DRC approval, TSP130009, for ten-four bedroom units on a single lot. Secondary means of egress windows do exist in the FBC defined Fire Separation Areas distance between units. The Residential Building Permits remain issued as individual three bedroom residential single family and duplex units and the owner has yet to submit the *permit required signed and notarized owner's affidavit of occupancy* mandated by permit for each issued building permits TBB 130329, TBB 130330, TBB 130331, TBB 130332, TBB 130333, and TBB 130334. Fire sprinklers permits were recently added for all ten units but, the residential building permits remain open as three bedrooms per unit and the four bedroom construction continues. Laws may be in Material Violation and as an open building permit, a material violation appeal is not applicable.

Questions: Is the Campus Block FSU Redevelopment, a 10 unit 40 unrelated person student apartment complex on a single parcel in Tallahassee, Florida exempt from the *Fire Separation Distance* openings protection and other requirements of the 2010 Florida Building Code or the 2010 FBC Residential Code?

Is the issuing of a Certification of Occupancy without correcting known Code violations a Material Violation of the Florida Building Code and Florida Law?

Project: Campus Block FSU ten Multifamily Apartments, Tallahassee, Florida (www.campusblockfsu.com) on one single parcel permitted under City of Tallahassee **BUILDING PERMITS: TBB 130330, TBB 130332 and TBB 130331, TBB 130329, TBB 130333, AND TBB 130334.**

Campus Block FSU Owner/Developer:
Patrick Chisholm, 2460 Forest Club Drive Orlando Florida 32804

City of Tallahassee Building Official:
Glen Dodson, 300 S Adams Street Tallahassee Florida 32301

Office of the City Attorney:
Hetal Desai, Attorney, 300 S Adams Street Tallahassee Florida 32301

Campus Block FSU Engineer of Record:
Edward H Bass III, PE, Moore Bass Consulting Inc.
805 N Gadsden Street Tallahassee Florida 32303

Florida Board of Professional Regulation, Architecture and Interior Design
C/O Ms. MH Allen
Smith Thompson Shaw Minacci & Colon, PA
3520 Thomasville Road 4th Floor Tallahassee, Florida 32309

Florida Board of Professional Regulation, Hotel and Restaurants
C/O Rick Akin
1940 N Monroe Street Tallahassee, Florida

Respectfully submitted this date by the Petitioner and affected party;

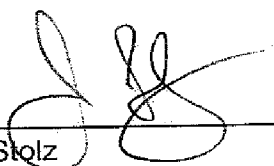

James Stolz

6-15-2013
Date

Attachments: Copy of EOR Site Plan, Issued Residential Permits as independent single family and duplex units
Florida Board of Professional Regulation, Architecture and Interior Design - Findings
Florida Board of Professional Regulation, Hotel and Restaurants - Findings
Appendix: Appendix of History and Background of the Question with City of Tallahassee Public Record Files attached as Exhibits

Webmail**jimstolz@centurylink.net**

Complaint - Unlicensed Activity

From : DHR Inspections, Tier N
<TierN.DHRInspections@myfloridalicense.com>

Tue, Jun 04, 2013 07:01 PM

Subject : Complaint - Unlicensed Activity

To : 'jimstolz@centurylink.net'
<jimstolz@centurylink.net>

Good afternoon – your complaint regarding unlicensed apartments 1864 West and Campus Block FSU was forwarded to the Division of Hotels and Restaurants for review and response.

An inspection was conducted on June 3, 2013 with the following results:

- 1864 West is under a 60 day warning to obtain a non-transient apartment license for 11 units
- Campus Block FSU is under construction and will be monitored for license application when construction is completed and they begin renting the units

I hope this information is helpful to you.

Thank you – Rick Akin.

Belle Vue Way

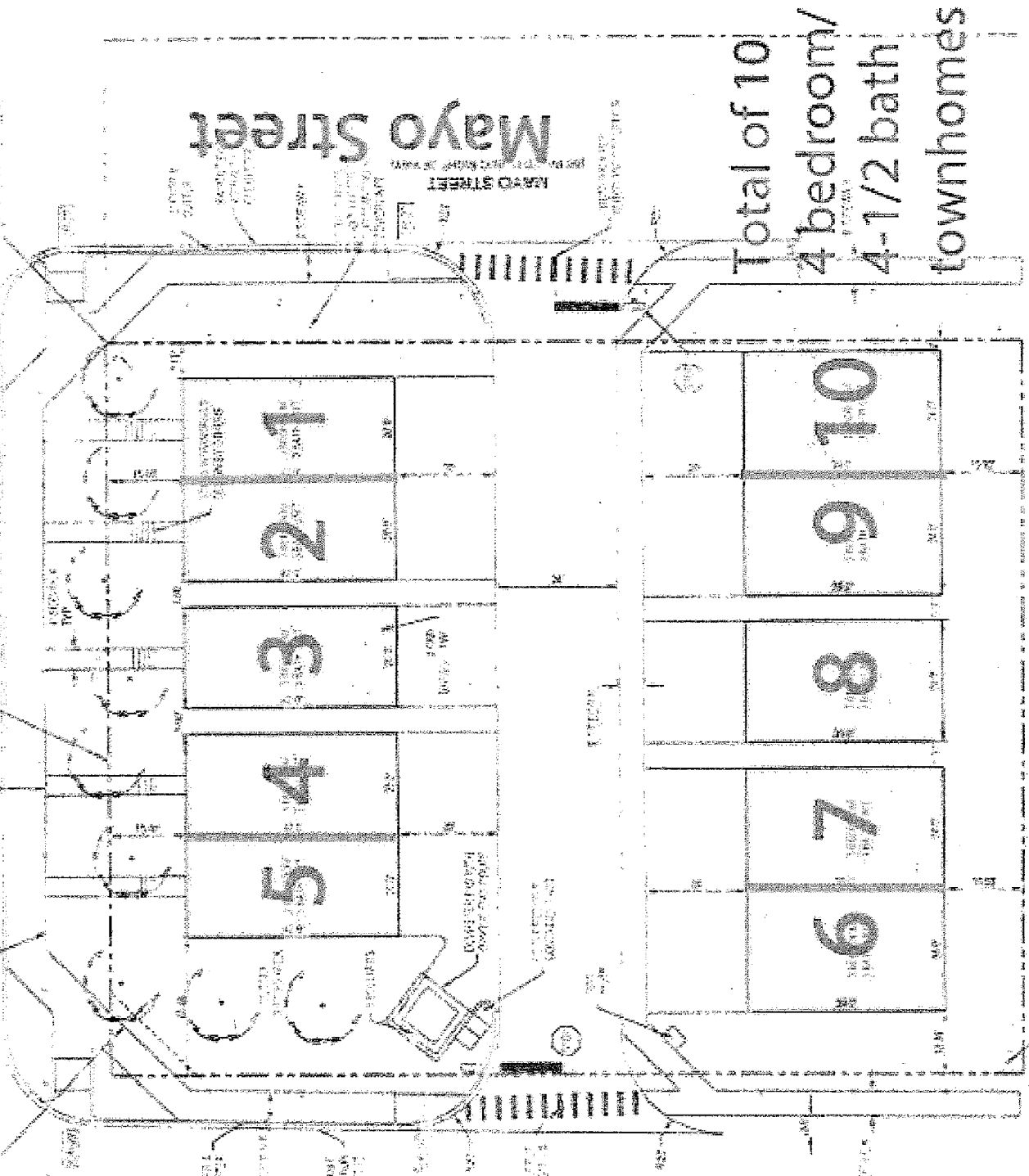

Total of 10
4 bedroom/
4-1/2 bath
townhomes

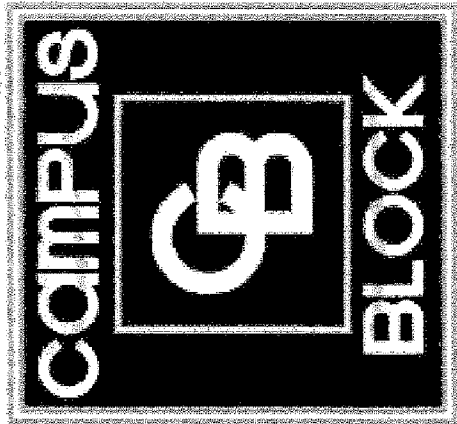

Murat Street

Mayo Street



Source: www.campusblockfsu.com, construction updates

Campus Block Apartments, ten units on one single parcel permitted as single family residential light frame construction, eight bedrooms on right Units #6 and #7 shown, four bedroom single Unit # 8 shown on left with 4 foot 10 inch separation between Units #7 and #8 with framed secondary egress window on the third floor shown.

Leased as 3 bedroom units with move in scheduled for August 15, 2013.

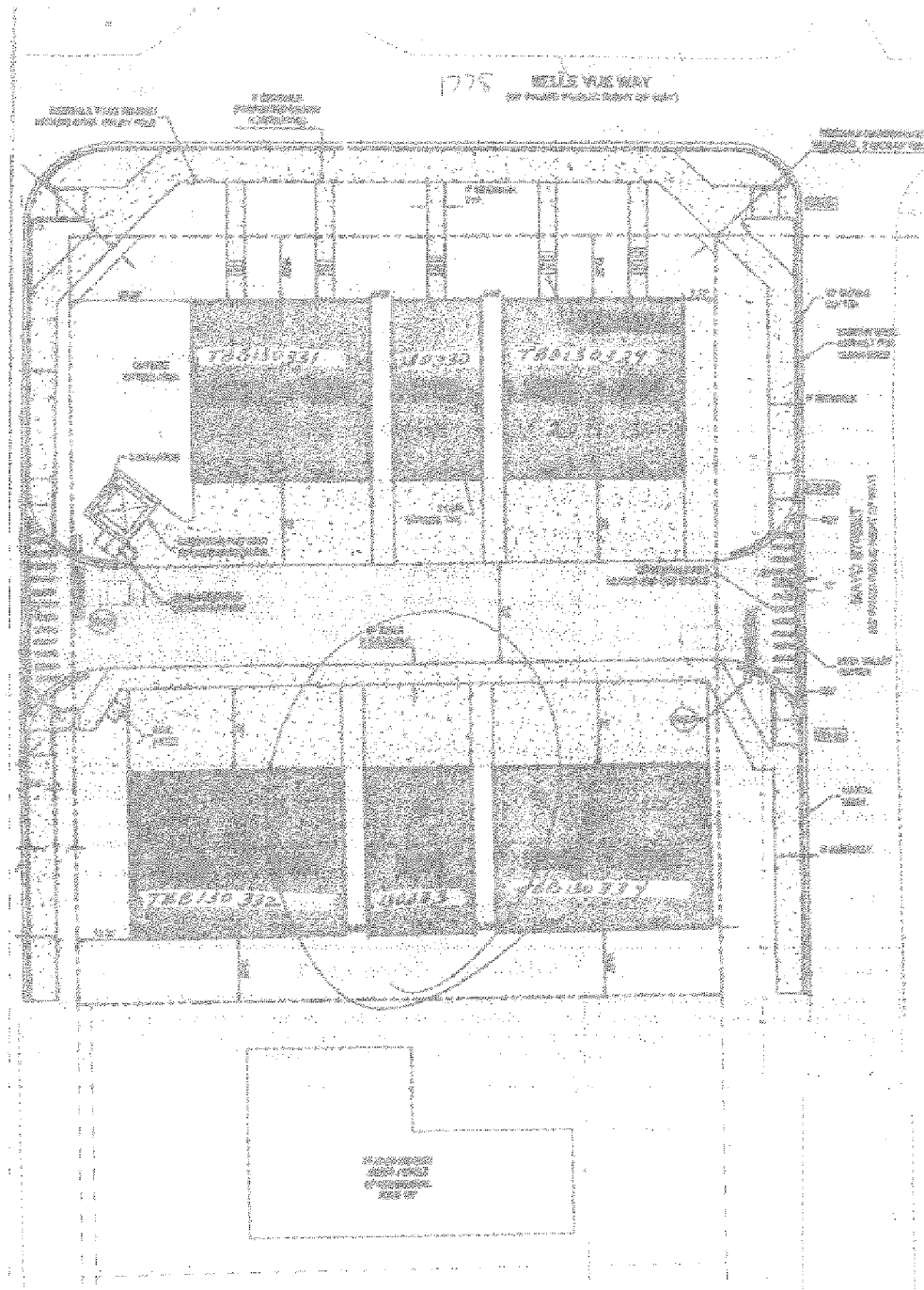

Source: COT Campus Block permitted EOR one parcel site plan TSP120026 and TSP13009 with assigned Residential Building Permit Numbers apportioned to each apartment unit.



COMBINATION RESIDENTIAL BUILDING, ENVIRONMENTAL, & DRIVEWAY CONNECTION PERMIT APPLICATION

HOLD C.O. by: _____

TBB #: 130333

***APPLICANT NOTICE: CHECKLIST ON PAGE 2 OR 3 MUST BE COMPLETED OR ATTACH THE APPROPRIATE CHECKLIST IF PERMIT IS FOR POOL, POOL RELINER, OR RETAINING WALL

Location: 300 1776 Belle View Way Mayo St Zip: 32304

Subdivision Name: _____ Lot _____ Blk _____ Unit Phase _____

Parcel I.D. No. (Tax Folio No.): 21 -- 35 -- 2022 -- 000 -- 0001-0

Property Owner: Campus Block FSU L.L.C. Telephone #: (407) 923-8366

Mailing Address: 2460 Forest Club Dr., Orlando, FL 32804

Contractor License No.: cgc 1505282 Telephone #: (850) 591-1897 Email: robkasper@comcast.net

Contractor & Firm Name: Old Farm Development L.L.C. Fax #: (850) 576-9177

Contractor Mailing Address: po box 20438 Tallahassee, FL 32316

Architect/Engineer: Jd Graham, Oasis Designs Fax #: _____

A/E Mailing Address: 5992 Ansell Ferrel Rd. Tallahassee, FL 32308

Sediment & Erosion Contact Name: Stege Contracting DEP #: 11229 Telephone #: (850) 544-2502

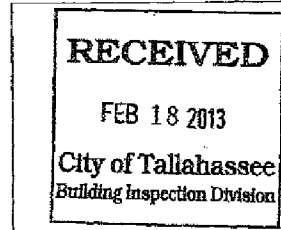

DESCRIPTION OF IMPROVEMENT	BUILDING CLASSIFICATION	TOTAL COST OF IMPROVEMENT:
01 <input checked="" type="checkbox"/> New	01 <input checked="" type="checkbox"/> One Family Detached	\$ 150000.00
02 <input type="checkbox"/> Addition	02 <input checked="" type="checkbox"/> Duplex	
03 <input type="checkbox"/> Alteration / Repair	12 <input type="checkbox"/> One Family Attached (___ # of attached units)	PRIVATE PROVIDER TO BE USED:
09 <input type="checkbox"/> Foundation Only	<input type="checkbox"/> Other _____	FL Statute 553.791 <input type="checkbox"/> Yes <input checked="" type="checkbox"/> No
10 <input type="checkbox"/> Pool / Pool Reliner		HAZARDOUS MATERIAL:
11 <input type="checkbox"/> Retaining Wall (separate permits required for Retaining Wall and Pool)		<input type="checkbox"/> Yes <input checked="" type="checkbox"/> No

THIS PERMIT IS FOR A <u>NEW</u> MASTER PLAN <input type="checkbox"/>	NUMBER of NEW DRIVEWAY CONNECTIONS: _____
THIS PERMIT HAS AN <u>EXISTING</u> MASTER PLAN <input type="checkbox"/>	
Permit #: _____	WATER & SEWER ACCOUNT & TAPS (MUST be completed for NEW construction)
Address: _____	Use Master Utility Account number (1 bill for multiple addresses) <input type="checkbox"/>
	OR Create A New Utility Account number (separate bill for each address) <input checked="" type="checkbox"/>
	Ship work orders at issuance of permit (water is needed within 2 weeks) <input checked="" type="checkbox"/>
	OR Delay shipping of work orders until: (provide date) _____

Scope of Work: SINGLE FAMILY

By signing below, the contractor acknowledges that products used in the construction of this building, requiring approval per FL Statutes 553.842 must have the required approval prior to installation in this building. Issuance of this building permit does not constitute approval of any product. Products that require approval per FS 553.842 are (1) panel walls, (2) exterior doors, (3) roofing products, (4) skylights, (5) windows, (6) shutters, (7) structural components, and (8) products comprising a building's envelope introduced as a result of new technology.

Contractor's Signature: [Signature] Print Name: Robert Kasper Date: _____

Source: COT Campus Block Apartments TBB130333 Residential Permit file

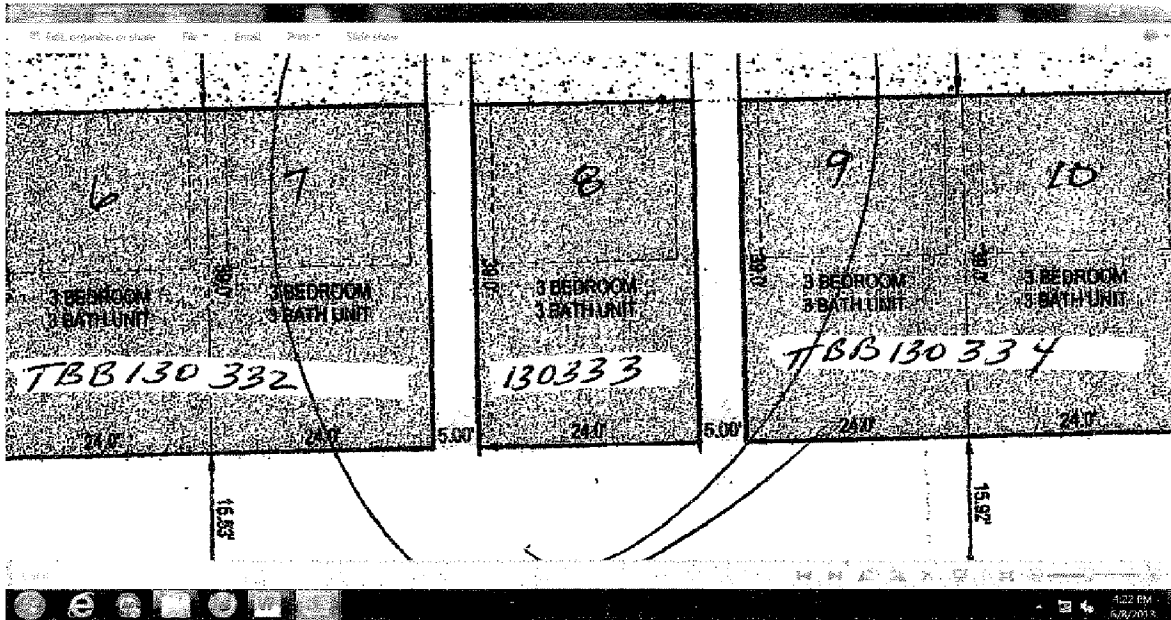

Source: COT Campus Block permitted EOR site plan TSP120026 and TSP13009 with assigned Residential Building Permit Numbers apportioned to each unit.

Note: five foot separation between foundations, add lap board siding and there is a four foot ten inch separation between walls. One half of that distance is two feet five inches. FBC Table 705.8 the *Maximum area of exterior wall openings based on fire separation and degree of opening protection*, any distance of less than 3 feet separation, any allowable opening area in any degree of opening protection is NOT PERMITTED. A secondary egress window exists on the third floor midway in the 39' unit length and is documented in Exhibit P, construction plans.



COMBINATION RESIDENTIAL BUILDING, ENVIRONMENTAL, & DRIVEWAY CONNECTION PERMIT APPLICATION

HOLD C.O. by: _____

TBB #: 130334

***APPLICANT NOTICE: CHECKLIST ON PAGE 2 OR 3 MUST BE COMPLETED OR ATTACH THE APPROPRIATE CHECKLIST IF PERMIT IS FOR POOL, POOL RELINER, OR RETAINING WALL

Location: 300 ~~1775 Belle Vista Dr~~ 192107 Zip: 32304

Subdivision Name: _____ Lot _____ Blk _____ Unit Phase _____

Parcel I.D. No. (Tax Folio No.): 21 - 35 - 22 000 - 0001-0

Property Owner: Campus Block FSO LLC Telephone #: 407 923 2764

Mailing Address: 2460 West Oak Dr. Orlando FL 32804

Contractor License No.: CC1505280 Telephone #: 850 511-1277 Email: rjokapv@comcast.net

Contractor & Firm Name: Old Firm Development LLC Fax #: 850 576-9177

Contractor Mailing Address: PO Box 20438 Tall. FL 32316

Architect/Engineer: JD BRAMAN, Oasis Designs Fax #: _____

A/E Mailing Address: 5712 Angell Road PD Tall. FL 32308

Sediment & Erosion Contact Name: STEVE CONNOR DEP #: 11229 Telephone #: 850 644-2502

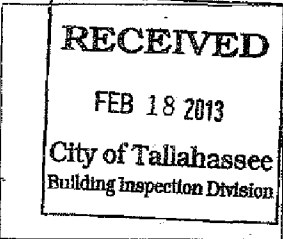

DESCRIPTION OF IMPROVEMENT	BUILDING CLASSIFICATION	TOTAL COST OF IMPROVEMENT:
01 <input checked="" type="checkbox"/> New	01 <input type="checkbox"/> One Family Detached	\$ 150,000.-
02 <input type="checkbox"/> Addition	02 <input checked="" type="checkbox"/> Duplex	
03 <input type="checkbox"/> Alteration / Repair	12 <input type="checkbox"/> One Family Attached (___ # of attached units)	PRIVATE PROVIDER TO BE USED:
09 <input type="checkbox"/> Foundation Only	___ <input type="checkbox"/> Other	FL Statute 553.791 <input type="checkbox"/> Yes <input checked="" type="checkbox"/> No
10 <input type="checkbox"/> Pool / Pool Reliner		HAZARDOUS MATERIAL:
11 <input type="checkbox"/> Retaining Wall (separate permits required for Retaining Wall and Pool)		<input type="checkbox"/> Yes <input checked="" type="checkbox"/> No

THIS PERMIT IS FOR A NEW MASTER PLAN

THIS PERMIT HAS AN EXISTING MASTER PLAN

Permit #: _____

Address: _____

NUMBER of NEW DRIVEWAY CONNECTIONS: _____

WATER & SEWER ACCOUNT & TAPS (MUST be completed for NEW construction)

Use Master Utility Account number (1 bill for multiple addresses)

OR Create A New Utility Account number (separate bill for each address)

Ship work orders at issuance of permit (water is needed within 2 weeks)

OR Delay shipping of work orders until: (provide date) _____

Scope of Work: Duplex

By signing below, the contractor acknowledges that products used in the construction of this building, requiring approval per FL Statutes 553.842 must have the required approval prior to installation in this building. Issuance of this building permit does not constitute approval of any product. Products that require approval per FS 553.842 are (1) panel walls, (2) exterior doors, (3) roofing products, (4) skylights, (5) windows, (6) shutters, (7) structural components, and (8) products comprising a building's envelope introduced as a result of new technology.

Contractor's Signature: [Signature] Print Name: Ronny Kegan Date: 2-12-13

Source: COT Campus Block Apartments TBB130334 Residential Permit file

APPENDIX

History and Background of the Question: RE: CITY OF TALLAHASSEE PUBLIC RECORD OF SITE PLAN TSP120026 and SITE PLAN TSP130009 and SINGLE FAMILY (TBB 130330, TBB 130333) AND TWO FAMILY RESIDENTIAL BUILDING PERMITS (TBB 130329, TBB 130331, TBB 130332, AND TBB 130334).

The following inquiries relate to the above referenced Public Record Submittals of the proposed Campus Block Redevelopment scheme to add a 10 unit 40 unrelated person student apartment complex on a single 0.58 acre lot in Tallahassee, Florida. All exhibits and inquiries exist in the City of Tallahassee Public Records Files.

It appears;

1. The Engineer of Record's (EOR's) November 8, 2012, TSP120026 (Development Site Plan Review) Narrative requests the review of the redevelopment's occupant load based upon the applicant's submitted load for (10) three bedroom, three bath multi-family units on two existing lots that are to be unified as one parcel (*EXHIBIT A*). *Parcels 21-35-22-000-0010 and 21-35-22-000-0020* were recorded in the Leon County Clerk of the Court Office as a single parcel using the Unity in Title legal instrument (*EXHIBIT B*).
2. November 21, 2012 *Preliminary Certificate of Concurrency*, TCM120046 issued to Campus Block for; *Land Use of (10) Residential – Apartments on Parcels 21-35-22-000-0010 and 21-35-22-000-0020* (*EXHIBIT C*).
3. November 30, 2012, TSP120046 review comments for Campus Block (10) multi-family apartment units for *Parcels 21-35-22-000-0010 and 21-35-22-000-0020* posted on the City of Tallahassee public record website (*EXHIBIT D*).
4. November 30, 2012, Development Review Committee (DRC) Fire Review comments state the Campus Block buildings do not meet the exceptions stated in *Florida Law F.S. 533.895(2)*. Fire Sprinklers must be installed in each apartment unit (*EXHIBIT D*).
5. November 30, 2012 DRC Fire Review comments require the applicant to submit assembly occupant load calculations in order to determine fire sprinkler requirements *Florida Fire Protection Code 2010 Edition, NFPA 101 12.3.5 Florida Edition* (*EXHIBIT D*).
6. December 10, 2012, Campus Block DRC committee TSP120046 site plan review was continued for further review.
7. December 19, 2012, EOR's DRC review response states that the sprinkler system is not required for the three bedroom and study hall units proposed under TSP120046 (*EXHIBIT E*).

8. December 20, 2012, the applicant's website advertises that Campus Block Redevelopment is a 10 unit, 40 bedroom, 45 bathroom apartment complex (*EXHIBIT F*).
9. The EOR stated in public record to the DRC that the Campus Block website (www.campusblockfsu.com) was in error and that the Campus Block Redevelopment remains a 10 dwelling unit, 30 bedroom and 30 bathroom redevelopment (*EXHIBIT E*).
10. Campus Block is a multi-family redevelopment, not a single family or two family dwelling development on individual parcels. Campus Block Redevelopment is clearly larger than two dwelling units on one parcel. Campus Block apartment redevelopment is a single parcel lot that will house 40 independent persons that are not members of the same family group under joint occupancy and that are under single management for the (10) 4 bedroom apartment units (*EXHIBIT F*).
11. Campus Block *Florida Building Code (FBC)* occupancy clearly must be designated as *FBC 2010 Section 310 Residential Group R, R-2 Apartment containing more than two dwelling units* classification.
12. On January 28, 2013, *TSP120026* DRC hearing, the Campus Block *Site Plan* had been approved for 10 multi-family dwelling units (30 beds) at a density of 16.94 units per acre (*EXHIBIT G*).
13. On February 1, 2013 *TCM120046*, Certificate of Concurrency was issued to Campus Block for a *Land Use of 10 Residential – Apartments on Parcels 21-35-22-000-0010 and 21-35-22-000-0020* (Unity of Title by owner to one parcel).
14. February 26, 2013, Campus Block's Building Permits were submitted as single and two family dwellings with the required Zoning approval being signed off by a planner (*EXHIBIT H*).
15. February 26, 2013, Campus Block's Building Permits with the required review of Environmental was signed off by a planner, a non-engineer for Professional Engineer Jimmy Lee (Cindy Smith for JL).
16. February 27, 2013, Campus Block's Building Permits required review of Building was signed off as individual one and two family residential permits.
17. Required review of Fire, is not signed off (*EXHIBIT H*).
18. Use of *FBC 2010 Residential* code application does not require a *Fire Review*.
19. *FBC 2010 Residential* Code is defined for single family building and two family building unit built on an individual parcel or site.
20. February 27, 2013, the EOR requested a Major Modification of DRC approval for 10 multi-family apartment redevelopment with a proposed new occupancy load of 4 bedrooms and 4.5 baths per unit or 40 persons on one parcel (*EXHIBIT I*).
21. Campus Block advertisements appear to be offering furnished individual bedroom leases, not a single four bedroom dwelling unit lease.

22. March 1, 2013 Campus Block building permits fees are paid for building permits for 3 bedroom, 3 bath units using *FBC 2010 Residential* single family and two family dwelling units permit applications (*EXHIBIT J*).
23. *FBC 2010 Residential* is the Code for single family and two family dwelling units and not three or more multifamily apartments located on a single parcel.
24. Campus Block Apartments were relabeled as single family and two family building unit with a "townhouse style" by City staff (*EXHIBIT K*).
25. March 1, 2013 Campus Block building permits were requested under the *FBC 2010 Residential*, not the *FBC 2010 Section 310 Residential Group R, R-2* code occupancy in which specifically includes; *more than two dwelling units where occupants are primarily permanent in nature, including apartments*.
26. An Architect, as defined by the *FBC*, has not signed and sealed the Campus Block apartment construction plans submitted for building permits.
27. Campus Block is light frame truss type construction over three units, not a townhouse development as defined by either the *FBC, FFPC or FS481*.
28. A second fire review was never conducted for the above referenced Campus Block under the requested *FBC Residential* building permits.
29. Campus Block has clearly requested and recorded a Unity of Title for Belle Vue Manor parcels *21-35-22-000-0010 and 21-35-22-000-0020* to form a single 0.58 acre lot, the basis for approval of TSP120046 (*EXHIBIT B*).
30. *Townhouse* is defined by the *FBC* as having property lines separating each unit.
31. Campus Block *Parcels 21-35-22-000-0010 and 21-35-22-000-0020* have not received any subdivision approval, nor has any recording of any subdivision Plat taken place before the referenced Campus Block building permits were issued. Campus Block Apartments are 10 dwelling units on a single lot.
32. Campus Block is one single parcel, any claim to use zero lot line separations between units to avoid the required fire separation requirements does not apply, *FBC Fire Separation Distance* code requirement applies.
33. The March 1, 2013 Campus Block building permit applications were based the applicant submitting (6) separate permits, (2) single family and (4) two family building residential code based permits for the same single parcel under *TBB 130330, TBB 130332, and TBB 130329, TBB 130331, TBB 130333, AND TBB 130334*.
34. The March 1, 2013 Campus Block submitted building permit plans did not include individual site plans for each permit requested. A ten unit site plan on a single parcel was submitted (*EXHIBIT L*).
35. Campus Block's submitted residential building permit applications list the project occupancy as three bedroom units (*EXHIBIT H*).
36. Campus Block's building permit applications on file fail to include the required signed and owner's notarized, *Affidavit of Occupancy (EXHIBIT M)*.

37. Campus Block's building permit applications were submitted by the applicant using *FBC 2010 Residential* code permit application, not the *FBC 2010 Edition* building code review permit application (*EXHIBIT H*).
38. Fire sprinklers were not included in the submitted building permit application.
39. Campus Block's applicant's separate February 27, 2013 request is submitted for a Major Modification approval to *TSP120046* that clearly specifies Campus Block as (10) multifamily apartments with 4 bedroom, 4.5 bathrooms per unit under *TSP130009* (*EXHIBIT N*).
40. The February 27, 2013, *TSP130009* site plan approval now requests a Major Modification approval to *TSP120046* to add a dedicated fire main and associated fire sprinkler services to the (10) individual (apartment) units (*EXHIBIT N*).
41. March 1, 2013 applicant applies for individual residential building permits for three bedroom single family and duplex units, non-sprinklered.
42. Adding sprinklers is required for three story four bedroom student housing that was first specified in the November 30, 2012, TSP120026 DRC apartment fire review comments (*EXHIBIT D*).
43. *1864 West* in Tallahassee was cited by the EOR and a City staff member as justification for Campus Block development (www.1864West.com) (*EXHIBIT E*).
44. Sprinklers for three story student housing has been required in the *FBC*, the *Fire Prevention Code* and by *Florida Statute*, unless the project meets the *Florida Residential Code* exception of one building per lot and no more than three bedrooms per residential unit.
45. The EOR states in public record that the development is 3 bedroom and a sprinkler system is not required citing *1864 West* (*EXHIBIT E*).
46. EOR again states in public record that the development is *Multifamily Apartment* and now requests modification to 4 bedrooms on one single lot (*EXHIBIT N*).
47. The Certificate of Concurrency states in public record that the development is a ten unit *Residential – Apartment* (*EXHIBIT O*).
48. Campus Block Redevelopment has removed a single story single family two-bedroom houses from 304 Mayo and is proposing a redevelopment within 16 feet (+/-) of the rear property boundary with (5) three story four bedroom multifamily apartments over thirty six feet (+/-) in height (*EXHIBIT P*).
49. The soffits of these units, 7 (*TBB130332*), 8 (*TBB130333*), and 9 (*TBB130334*) are open vented directly to the wood truss attic of each apartment unit and are separated by less than the required three feet.
50. Rinnai 199,000 BTUH gas fuel water heaters will be surface mounted on the exterior walls in the four foot ten inch *Fire Separation Areas* between apartments.
51. The gas water heaters will be non-flue units and open vented in proximity of apartment unit windows in the fire separation areas between units.

52. The Campus Block three story units have a wall separation distance as defined by *FBC* that is less than four feet ten inch separating units 7 and 8 and units 8 and 9 and units 2 and 3 and units 3 and 4 (*EXHIBIT Q*).
53. Campus Block is light frame truss type construction over three units in scope and is not a *townhouse* development as defined by the *FBC, FFPC and FS481*.
54. New construction built on the same lot is required by code to have a minimum *FBC Fire Separation Distance* or a solid rated fire wall separating the units.
55. Campus Block *Parcels 21-35-22-000-0010 and 21-35-22-000-0020* have not received any subdivision approval, nor has any recording of any subdivision Plat taken place before the referenced Campus Block building permits were issued.
56. Campus Block Apartments are clearly 10 multifamily units on a single lot with 40 independent tenants under one management.
57. The Campus Block *Fire Separation Distance* is defined by *FBC* as the distance to an imaginary line between two buildings on the same lot.
58. Campus Block's EOR chose to separate the apartment foundations by 5 feet.
59. With wall siding thickness, the *FBC* determined *Fire Separation Distance* is 2 feet 5 inches.
60. As per *FBC Table 705.8* or *FBC Residential Fire* separation minimum distance, the *Maximum area of exterior wall openings based on fire separation and degree of opening protection*, any distance of less than 3 feet separation, any allowable opening area in any degree of opening protection is **NOT PERMITTED**.
61. No openings are permitted in either unit's exterior walls between buildings separated by less than the *FBC Code* specified minimum *Table 705.8* values.
62. No windows are allowed in the separation between the units. It appears the Contractor may have been aware of this Code requirement when the upper floor middle bedroom was hand relabeled as a study hall and the lower study hall with a different exposure was hand relabeled as a bedroom creating three bedrooms with north and south façade windows (*EXHIBIT R*).
63. Windows, natural gas combustion fuel water heaters and other openings do exist in between the units with the 2 feet 5 inch *Fire Separation Distance* area.
64. The truss system is light frame wood truss. In the event of an vented attic fire, the three story Campus Block apartments could collapse to the south sending burning wood and debris on the adjacent single story occupied dwelling unit not tied into the Campus Block fire alert system.
65. The resulting redevelopment shall not be detrimental to the public good or to the surrounding properties.
66. Campus Block must comply with *FPC 69A.3.012, State Uniform Fire Safety Standards*.
67. Light frame truss type construction of more than three residential units must comply with *F.S. 633.027*.

68. In accordance with *Florida Statute 481*, Architect signed and sealed construction documents are required in the design and permitting of the 10 unit Campus Block apartment complex built on one single lot. Campus Block does not have a licensed Architect overseeing the apartment complex project.
69. The harm to the health of any resident or occupant or adjacent property occupants caused by a collapsing burning building will be a truly avoidable loss if the minimum *FBC Fire Separation Distance* requirements are not enforced.
70. The minimum *FBC Fire Separation* requirement allowing no permitted openings can and should be enforced.
71. Campus Block had numerous design options for their redevelopment layout and the EOR has chosen to maximize with the placement of 10 apartment units on the site with minimum separation between multiple units on a single parcel.
72. Campus Block's EOR chose the design and layout of their site. Campus Block chose the 5 foot foundation separation distance between buildings.
73. An initial Fire review was done in November 2012. The findings are in the public file under *TSP120026*. The November 30, 2012 Fire Review findings requiring sprinklers have been ignored by the DRC citing a claim that the Campus Block units are *single family and two family residential three bedroom townhouse style unit* and not apartments, thus Campus Block is claimed to be exempt from then more restrictive Codes and Florida Statutory requirements.
74. Development Review Managers are regulators that have the responsibility to address inquiries and review the Campus Block redevelopment plans.
75. The DRC members have knowledge of the public recorded *TSP120026* Fire Review comments.
76. Local officials do not have the authority to approve deviations from Florida Statute requirements. Local officials do not have the authority to approve deviations from Life Safety Code and the Fire Prevention Code.
77. The *TSP 130009* Major Modification's Development Review Committee Hearing had been scheduled and was held April 8, 2013 at 9 am (*EXHIBIT S*).
78. The Development Review Committee received a list of public inquiry concerns prior to the *TSP 130009* DRC Hearing. Those concerns were acknowledged by certain members of the DRC and are posted in public record for the referenced reviews of *TSP 130009* and for the building permit reviews of *TBB 130332*, *TBB 130333*, and *TBB 130334*.
79. The Development Review Committee's Site Plan reviews must evaluate all design choices for their impact and consequences based upon the public good.
80. The Development Review Committee approved with conditions the Campus Block three story apartment complex for 4 bedrooms with a five foot foundation separation between exterior walls of adjacent units.

81. Residential building permits have been issued under *TBB 130330, TBB 130333, and TBB 130332, TBB 130329, TBB 130331, TBB 130334* that allow the four foot - ten inch face of wall to face of wall building separation between units with the allowance of openings in these adjacent apartment unit exterior walls.
82. As of this date, construction continues with all unit slabs poured with five foot separations and with the light construction wood framing units being quickly erected without an Architect's oversight.
83. Campus Block is being constructed as ten-four bedroom, four and one half bathroom units, the public record file building permits remain issued as ten-three bedroom three bathroom units.
84. Windows are installed on the walls in the four foot ten inch Fire Separation Areas between buildings. This is contrary to *FBC Table 705.8* and is in material violation Code requirements. No openings are permitted as per *FBC Table 705.8*.
85. The Campus Block issued Building Permits appear to remain as three bedroom units, not four bedroom units as approved under EOR modification *TSP130009*.
86. It appears that the owner has still failed to submit the required owner *signed and notarized Affidavit of Occupancy* for each issued permit, *TBB 130330, TBB 130333, and TBB 130332, TBB 130329, TBB 130331, TBB 130334*.
87. By and through the issuing of building permits, local officials must certify that the reviewed Campus Block FSU project has met all *applicable* Code and Florida Statutory requirements (including the *F.S.481, exception*) and when realized that the project is not in compliance take corrective measures to bring the material violations into compliance.
88. Failing to alter the issued Residential Building Permits to correct the cited deficiencies, failing to require the owner's signed and notarized affidavit of occupancy for each unit and through the issuing Certificate of Occupancies without either requirement, would now clearly appear to be a blatant material violation of the Law.
89. Florida Board of Professional Regulation has reviewed the project for unlicensed activity, Campus Block is an apartment occupancy classification.

ADDITION CONCERNS REGARDING VIOLATIONS OF Florida Fire Prevention Code, Florida Building Code, and Florida Statutes

COT Site Plan Approval of 1864 West. City of Tallahassee, TSP110042 Site Plan File

There seems to be a pattern of three story student apartment housing projects on one lot being permitted as three bedroom residential units then leased and occupied by four independent tenants, after the three bedroom certificate of occupancy is issued, as an apartment complex without any sprinkler system being installed (www.1864west.com). These units are also being permitted and constructed without an Architect or a proper fire or Life safety review oversight.

Someone could be seriously injured or killed due to the lack of this proper oversight.

1864 West in Tallahassee was cited by the Engineer of Record as justification for Campus Block development. *1864 West* Public Record File, it appears to have been permitted as a three story, three bedroom and study hall residences without fire sprinklers permitted in 2011 apparently as a three story three bedroom per unit and is now occupied as 11 four bedroom individual tenant apartments, 44 independent tenants all under one management (www.1864West.com). The *1864 West* apartment complex should also be investigated for discrepancies in Florida Statute and other Life Safety and Code applications.

The DBPR Hotels and Restaurants Division has reviewed *1864 West* and found it to be an apartment not in compliance with their license requirements.

This issue may be much broader statewide and should be addressed by the Florida Building Commission. Changing the FBC and FBC-Residential Code definitions of single family residential to include the terms **on one lot** may greatly reduce the misconception being created or close the loophole used by intention.



Land Use Planning • Engineering Design • Environmental Permitting • Landscape Architecture • Surveying

**Type 'B' Site Plan Narrative
For
Campus Block
Belle Vue Way at Mayo Street
Tallahassee, Florida**

Parcel ID # 21-35-22-000-001-0 and 21-35-22-000-002-0
MBC #2398.001/12-161

November 8, 2012

Land Use

Proposed for development is a 10 unit, 3 bedroom 3 bath multi-family apartment complex located on Belle Vue Way. Total acreage is 0.58 acres, resulting in a density of 11.21 units per acre. The site is currently zoned University Transition, which allows up to 50 units per acre gross density. All residential buildings are designed as three story units, with two car garages serving each.

The site lies within the Multi-Modal Transportation District (MMTD), Transect 5.

Traffic and Site Circulation

Site access is shown from Mayo Street and Murat Street, connecting via a two way, 24 foot wide driveway, which then services each garage via stand alone concrete driveways.

On-site circulation has been shown meeting BUS-40 standards. The Autoturn plan may be referenced as part of the Type B site plan set.

Total parking provided is 20 garaged spaces which is within the allowable Code parking of 18 to 27 spaces. Bicycle spaces within the MMTD are required to be covered and secured, thus each unit's garage shall have a bicycle storage rack installed within them.

Environmental

The site has received a Natural Features Inventory Exemption. The site has several large slash Pine trees existing, which do not warrant preservation. Hardwood Oaks shall be planted back to provide reforestation per the EMO.

Utilities

The site shall be served by City of Tallahassee Solid Waste, electric, gas, sewer and water. Solid waste is shown being handled by a trash dumpster adjacent to the main drive aisle, as well as (2) 3 ft by 4 ft recycling container pads provided. The solid waste facility shall be fully enclosed with fencing or a wall, minimum 9 feet in height to ensure complete opaque screening.

Proposed sewer is shown outfalling from the various buildings via 4 inch services into a 6 inch diameter service that then ties into the City's existing sewer mains within Mayo

人 物 志

Street and Belle Vue Way. This method of collection has been proposed to minimize the amount of open cuts that would be required if each unit was individually serviced. Each 6 inch service serves 5 residential units, which is more than ample size.

Potable water is shown being provided from Murat Street right of way, with (4) 1.5 inch services proposed, which are then manifold off into 5/8 inch meter assemblies to serve the individual units.

Fire protection has been provided by the placement of a fire hydrant immediately adjacent to the driveway off Murat Street.

Stormwater

The site is located within the Elberta Regional Stormwater Facility contributing drainage basin and is thus eligible to participate in the proportionate fair share connection fee process. The developer has opted to proceed with the connection fee. The stormwater for the project is shown being captured and conveyed into the existing roadside concrete swale system along Belle Vue Way, which, due to the running slope of the concrete ditch, has ample capacity for the proposed impervious area associated with this project.

A

A

EXHIBIT B

	Land Use & Environmental Services Division (850) 891-7100
	Location: 435 N. Macomb Street
	Mail: 300 S. Adams Street, Box B-28, Tallahassee, Florida 32301-1731
	Fax: (850) 891-7184 Florida Relay Service TDD: 711

UNITY OF TITLE

In consideration of combining the subject properties owned by Campus Block FSU, LLC which lie within the corporate limits of the City of Tallahassee, Florida, the Undersigned hereby agrees to restrict the use of Parcel Numbers 21-35-22-000-001-0 and 21-35-22-000-002-0 Leon County, Florida, and property otherwise being described by metes and bounds, (attach legal description as Exhibit Number 1) in the following manner:

1. That said property shall be considered as one plot and parcel of land, and that no portion of said plot and parcel of land shall be sold, transferred, devised or assigned separately, except in its entirety as one plot or parcel of land. Any further subdivision of said plot and parcel of land shall comply with the City of Tallahassee Land Development Code.
2. The Undersigned further agrees that this condition, restriction and limitation shall be deemed a covenant running with the land, and shall remain in full force and effect, and be binding upon the Undersigned, their heirs and assigns. A release of this Unity of Title must be executed by the City Manager and the City Attorney (or their designee).
3. The Undersigned further agrees that this instrument will be recorded in the Public Records of Leon County, Florida.

Signed, sealed, executed and acknowledged on this 23rd day of October, 2012, at Tallahassee, Florida.

Owner(s) Signature
Patrick Chisholm

Witness(es) Signature
Alison Taber
Gabriel Lemmerman

State of Florida,
County of Leon

The foregoing instrument was acknowledged before me by Patrick Chisholm who is personally known to me or who has produced as identification and who did not take an oath.

WITNESS my hand and official seal this 23rd day of October A. D., 2012.

Alison Taber
Notary Public
State of Florida at Large

My Commission Expires:
(seal)



Name and Address of Person preparing this instrument:
Edward N. Bass III, P.E., Moore Bass Consulting, 805 N. Gadsden St., Tallahassee, FL 32303

Revised: 11/8/11
Expires: 9/30/12

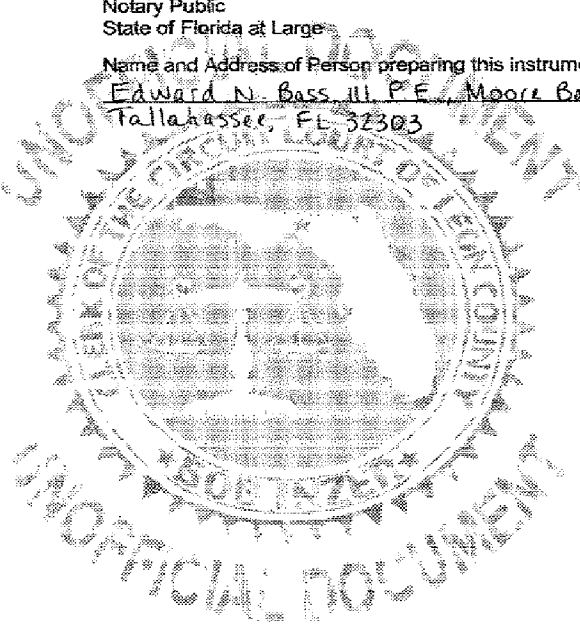

EXHIBIT #1

LEGAL DESCRIPTION:

LOT 1 AND LOT 2 OF BELLE VUE MANOR, A SUBDIVISION AS PER MAP OR PLAT THEREOF
RECORDED IN PLAT BOOK 3, PAGE 76 OF THE PUBLIC RECORDS OF LEON COUNTY,
FLORIDA.

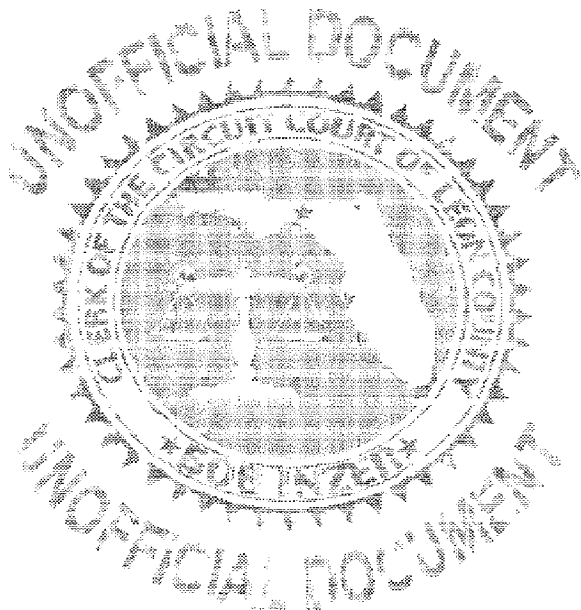

EXHIBIT C

Certificate Number: TCM120046
Date Issued: 11/21/2012
Expiration Date: 01/02/2013

CITY OF TALLAHASSEE
PRELIMINARY CERTIFICATE OF CONCURRENCY

Applicant: CAMPUS BLOCK FSU LLC
Owner: CAMPUS BLOCK FSU LLC
Project Name: CAMPUS BLOCK
Project Location: 300 & 304 MAYO STREET

PARCEL I.D. NUMBER(S):
21-35-22-000-0010
21-35-22-000-0020
300 MAYO ST T/LC

Type of Land Use: Residential-Apartment
Amount: 10

Sq. Ft./# of Units:
~~BEDS~~ DU FB

COMMENTS: 10 du / 30 beds, replaces 2 existing single fam du

Your concurrency has been obligated through the expiration date shown above. This is to remind you that after that date, if your project has not been submitted for Site Plan review/approval, the project will be considered withdrawn. In order to reinstate the project, a new application and fees must be submitted.

This certificate is issued pursuant to City of Tallahassee Ordinance Number 90-0-0080AA. Based upon the information submitted by the applicant, this certificate certifies that a development with the land use densities and intensities specified at the location specified above will have adequate infrastructure capacity tentatively reserved for water, sewer, solid waste, stormwater, parks, transit and roads to serve the needs of the development. The information provided by the applicant has not been verified as accurate by staff. This permit in no way gives the proposed development any final authorization to develop, nor does it absolve the applicant from fulfilling the requirements of any Federal, State, County, or City Laws or regulations related to land use or land development.

Dwight R. Arnold, Jr.,
Development Review Administrator

11/21/2012
Date

- The above project has received Final Development Approval and the Approved Site Plan/Plat is attached for your review.
- The above project has been modified from the original submittal.
- The above project has been denied Final Development Approval.

Land Use Administration/Growth Management

Date

2. 10/11/11

C.

MEMORANDUM

TO: Development Review Committee Members
FROM: Blas Gomez, Engineering Manager
Water Resources Engineering Division
DATE: November 30, 2012
SUBJECT: DRC Utility Review Comments
Campus Block (TSP120026)

Tax ID No. # 21-35-22-000-0010 and 21-35-22-000-0020
DRC Meeting Date December 10, 2012

I. Project Description:

Campus Block (TSP120026) located on 0.59-acre at 300 and 304 Mayo Street. The proposed project is to construct 10 multi-family units at a density of 16.95 units per acre. The applicant is also requesting a deviation to the development standards in order to reduce the 2nd story step back requirement from 15 feet to 0 feet. The site is zoned UT (University Transition)

II. Standards of Review:

Water Utility Comments

Water Utility reviews concept plans for compliance with, *the Water and Sewer Agreement, the City of Tallahassee Standard Specifications for the Design and Construction of Water and Wastewater Facilities (January 2006), Florida Department of Environmental Protection (FDEP) F.A.C. Section 62-555, The American Water Works Associations Manual of Practice "M31", FDEP F.A.C. Section 62-604, and FDEP MOP 9*, as well as sound engineering practice.

Electric Utility Comments

The Electric Utility reviews concept plans for compliance with approved National Electric Safety codes and all applicable local electric codes.

Gas Utility Comments

The Gas Utility review is in compliance with Department of Transportation Title 49 Parts 191 and 192 Pipeline Safety Regulations, and The Florida Public Service Commission Chapter 25-12 Safety of Gas Transportation By Pipeline.

III. Findings of Fact:

Water Utility Comments

Sewer is available via 6" clay line in Mayo Street, Belle Vue Way and Murat Street.

Water is available via a 6" universal line on Murat Street and Belle Vue Way. It is also available via a 2" line on Mayo Street, however it is not recommended any water services be connected to the 2" line.

Connection to the City's water and sewer system is required per Chapter 21 of the City of Tallahassee's Code of Ordinances.

Fire Department Comments

*The Required width of a fire department access road shall not be obstructed in any manner, including the parking of vehicles. *NFPA 1, 18.2.3.1.1, (2010 Edition of the Florida Fire Prevention Code, 2009, edition).*

1. Needed Fire Flow calculations are not provided on the Required Fire Flow Information Form (attached). *NFPA 1, 18.4.1.1 and NFPA 1, 18.3.3, (2010 Florida Fire Prevention Code, 2009 Edition).*
2. Fire department connection(s) are not shown on plans. *NFPA 13, 8.17.2.4.6, (NFPA 13: Standard for the Installation of Sprinkler Systems, 2007 edition).*
3. Post Indicator Valve is not shown on plans. *NFPA 13, 8.16.1.5.1, (NFPA 13: Standard for the Installation of Sprinkler Systems, 2007 Edition).*
4. Double Detector Check Valve assembly is not shown on the plans. City Ordinance 90-O-0017.

DRC Comments – **Campus Block (TSP120026)**

November 30, 2012

Page 3

5. Installation of fire sprinklers is not specified on plans:

(1) Buildings are three stories or more and do not meet the exceptions stated in *Florida law. F.S. 533.895(2)*.

(2) Please provide assembly occupant load calculations on the Required Fire Flow Information form in order to determine fire sprinkler requirements. *NFPA 101, 12.3.5, (2010 Florida Fire Protection Code 2009 Edition)*.

Electric Utility Comments

Single phase power is available to serve this project from the existing City of Tallahassee overhead electric distribution system on the westside of Mayo Street and Murat Street. Three (3) phase power is available on the southside of Belle Vue Way to qualified applicant.

Gas Utility Comments

Gas Utility has gas mains in the vicinity of the proposed development site for Campus Block. At the request of the owner or the developer, gas services will be provided to the project site.

IV. Condition of Approval:

Water Utility Comments

An approved service plan will be required as a condition of approval. Water and Sewer demands must also be submitted.

As typical the developer must supply needed fire flow calculations and have approval from the Fire Department that the proposed fire protection will be adequate for the development.

Fire Department Comments

- 1. Must meet NFF (needed fire flow) as determined by AWWA Manual M31, using NFPA 1 Method. Please provide needed fire flow calculations to the Tallahassee Fire Department representative and to Water Utilities Engineering and Inspections at this time. Please use the Required Fire Flow Information form (NFPA 1, 18.4.1.1, 2009 Edition) included with**

DRC Comments – Campus Block (TSP120026)

November 30, 2012

Page 4

these comments to provide fire flow calculations. If hydrants are existing the following is required. After the NFF is determined, the existing fire hydrant(s) shall be flowed to determine its GPM. If the GPM meets or exceeds the NFF, no additional hydrants are required. If it does not meet the NFF, additional hydrant(s) are required.

2. Please state on plans that a fire sprinkler system shall be installed:
 - (1) Buildings are three stories or more and do not meet the exceptions stated in *Florida law. F.S. 533.895(2)*
 - (2) Please provide assembly occupant load calculations on the Required Fire Flow Information form in order to determine fire sprinkler requirements. *Florida Fire Protection Code 2010 Edition, NFPA 101, 12.3.5, Florida Edition.*
3. If an automatic sprinkler system is required, the fire department connection (FDC) for the sprinkler system shall be located within 100 feet of a fire hydrant. A post indicator valve is required at the point where the water distribution system becomes exclusively used for a fire sprinkler system. Please show FDC and post indicator valve locations on plans.
4. Every fire department connection shall be so located, with respect to hydrants, driveways, buildings and landscaping; that fire apparatus and hose connected to supply the system will not obstruct access to the buildings for other fire apparatus. Fire department connections shall be located in front of the building(s) they serve, shall be fully visible and recognizable from the street or nearest point of fire department apparatus accessibility, and shall be provided with address signage. Please show FDC location meeting the above stated code requirements.

Electric Utility Comments

Concurrent to a request for a building permit, the applicant shall furnish the Power Engineering Division with two (2) sets of construction plans for this project in hard copy and one (1) set in electronic format (AutoCAD DWG Format), which shall include at a minimum the following:

- Approved site plan
- Architectural plan
- Electric Riser diagram (one-line diagram)
- Electric loads

DRC Comments – **Campus Block (TSP120026)**

November 30, 2012

Page 5

Upon receipt of the noted plans, Power Engineering will design the electric service. Plans will be reviewed for permitting approval and will be marked with the electrical design and with applicable comments. After review by the electric, meter and water departments the plans must be taken from Water Utilities to Growth Management. One set of permitted plans will be returned with the building permit and shall be kept on the construction site for the duration of the project.

Based on the building setback of only 2.25 feet along Belle Vue Way and a 1 foot setback along Mayo Street, there may be a clearance violation from the power lines along these two (2) roads. The OSHA power line safety rule 1926.1408 requires a minimum working space of ten (10) feet from overhead electric lines. The developer need to keep this in mind as the building designs and setbacks are finalize. Note this ten (10) feet is not from the building, but from the scaffolding and equipment used during construction. Additionally, cranes are required to have a twenty (20) feet clearance from the power lines.

The developer shall bear the costs (labor, administrative, and equipment costs) associated with the relocation of any existing City of Tallahassee electric equipment due to conflicts with the proposed project.

The exact location of the transformers, which will serve the proposed buildings will be determined by Power Engineering at the time that the plans are permitted.

No tall growing trees are allowed within thirty feet of an existing overhead power line. A list of acceptable plants near power lines is available from Perry Odom – 850- 891-5181.

Please contact Kendrick Roberts of the Electric Utility at 850-891-5609 to coordinate this project.

Gas Utility Comments

In order to determine engineering requirements, developers are asked to complete the *Request for Gas service form*. Please ask for this form by contacting either Vicki O'Neil at 891-5569 (Vicki.Oneil@talgov.com) or Lara Kuleshova at 891-2380 (Larisa.Kuleshova@talgov.com), Natural Gas Sales and Marketing, Underground Utilities.

Design assistance to integrate natural gas is available. Applicant will need to provide Gas Utility with a set of construction plans in both PDF and AutoCAD

DRC Comments – **Campus Block (TSP120026)**

November 30, 2012

Page 6

format, which will include at a minimum: Approved utility plan, architectural plan showing gas meter locations with proposed loads to each meter and landscape plans. Please contact Stephen Mayfield, Manager Gas Operations and Business Development, at 891-5118 (Stephen.Mayfield@talgov.com).

Solid Waste Comments

Garbage & Recycling pads are approved as shown on the site plan.

V. Recommendation:

Approved, subject to the above conditions.

CONDITIONS OF APPROVAL:

1. Must meet NFF (needed fire flow) as determined by AWWA Manual M31, using NFPA 1 Method. Please provide needed fire flow calculations to the Tallahassee Fire Department representative and to Water Utilities Engineering and Inspections at this time. Please use the Required Fire Flow Information form (NFPA 1, 18.4.1.1, 2009 Edition) included with these comments to provide fire flow calculations. If hydrants are existing the following is required. After the NFF is determined, the existing fire hydrant(s) shall be flowed to determine its GPM. If the GPM meets or exceeds the NFF, no additional hydrants are required. If it does not meet the NFF, additional hydrant(s) are required.
2. Please state on plans that a fire sprinkler system shall be installed:
 - (1) Buildings are three stories or more and do not meet the exceptions stated in *Florida law. F.S. 533.895(2)*
 - (2) Please provide assembly occupant load calculations on the Required Fire Flow Information form in order to determine fire sprinkler requirements. *Florida Fire Protection Code 2010 Edition, NFPA 101, 12.3.5, Florida Edition.*
3. If an automatic sprinkler system is required, the fire department connection (FDC) for the sprinkler system shall be located within 100 feet of a fire hydrant. A post indicator valve is required at the point where the water distribution system becomes exclusively used for a fire sprinkler system. Please show FDC and post indicator valve locations on plans.
4. Every fire department connection shall be so located, with respect to hydrants, driveways, buildings and landscaping; that fire apparatus and hose connected to supply the system will not obstruct access to the buildings for other fire apparatus. Fire department connections shall be located in front of the building(s) they serve, shall be fully visible and recognizable from the street or nearest point of fire department apparatus accessibility, and shall be provided with address signage. Please show FDC location meeting the above stated code requirements.

Gary Donaldson
Tallahassee Fire Department
327 N. Adams St
Tallahassee FL 32301
(850)891-7179
Gary.Donaldson@talgov.com



(2) Except for single-family and two-family dwellings, any building which is of three stories or more and for which the construction contract is let after January 1, 1994, regardless of occupancy classification and including any building which is subject to s. 509.215, shall be equipped with an automatic sprinkler system installed in compliance with the provisions of chapter 633 and the rules and codes adopted pursuant thereto.

Response: NFF calculations have been provided as requested. Additionally a hydrant has been shown being placed adjacent to the driveway connection to Murat Street

2. Please state on plans that a fire sprinkler system shall be installed:
 - (1) Buildings are three stories or more and do not meet the exceptions stated in *Florida law. F.S. 533.895(2)*
 - (2) Please provide assembly occupant load calculations on the Required Fire Flow Information form in order to determine fire sprinkler requirements. *Florida Fire Protection Code 2010 Edition, NFPA 101, 12.3.5, Florida Edition.*

Response: It is our understanding from the architect as well as the General Contractor that sprinkler systems are not required for the 3 bedroom units proposed. The same units were just completed on the project known as 1864 West, and no sprinklers were required for those units. If it is determined at the time of building permit application that sprinklers are required then the plans will be revised to reflect the proper connections, FDC and post indicator valves accordingly.

3. If an automatic sprinkler system is required, the fire department connection (FDC) for the sprinkler system shall be located within 100 feet of a fire hydrant. A post indicator valve is required at the point where the water distribution system becomes exclusively used for a fire sprinkler system. Please show FDC and post indicator valve locations on plans.

Response: See response to Comment 2 above.

4. Every fire department connection shall be so located, with respect to hydrants, driveways, buildings and landscaping; that fire apparatus and hose connected to supply the system will not obstruct access to the buildings for other fire apparatus. Fire department connections shall be located in front of the building(s) they serve, shall be fully visible and recognizable from the street or nearest point of fire department apparatus accessibility, and shall be provided with address signage. Please show FDC location meeting the above stated code requirements.

Response: See response to Comment 2 above.

Revised Site Plan drawings have been uploaded to ProjectDox for your review and approval. Should you have any further questions, please do not hesitate to contact our office.

Sincerely,
Moore Bass Consulting, Inc.



Edward N. Bass, III, P.E.

Belle Vue Way

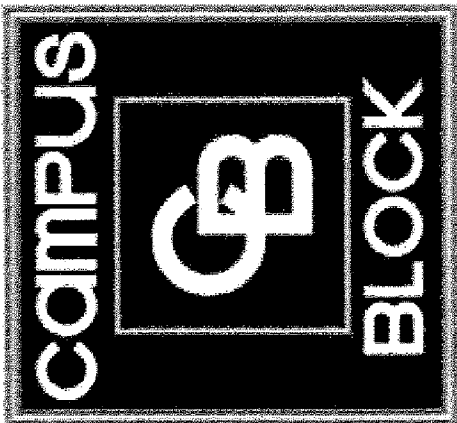
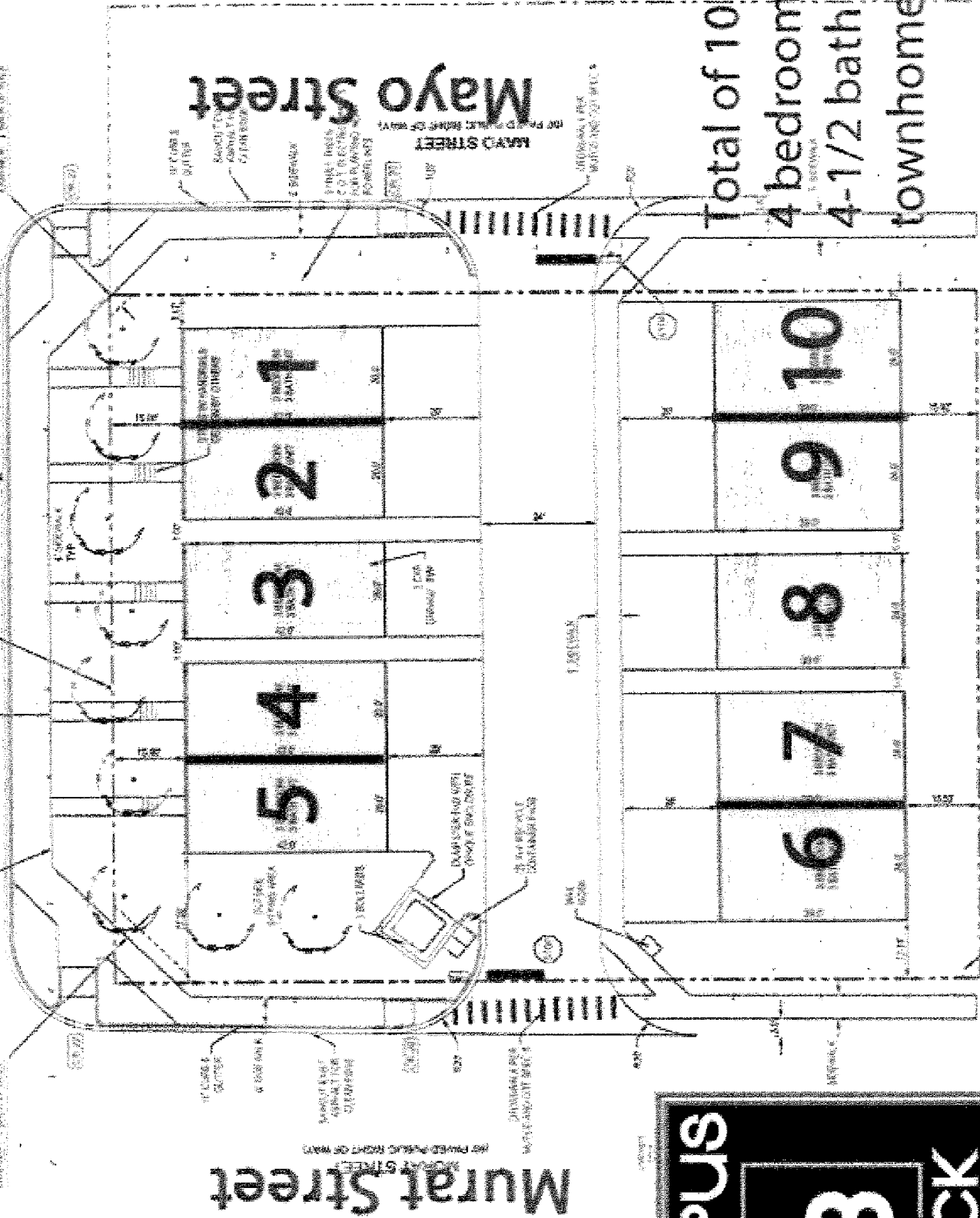

Total of 10
4 bedroom/
4-1/2 bath
townhomes

SEE PLAN FOR
DIMENSIONS AND
NOTES

EXHIBIT E

FIRST FLOOR LEVEL

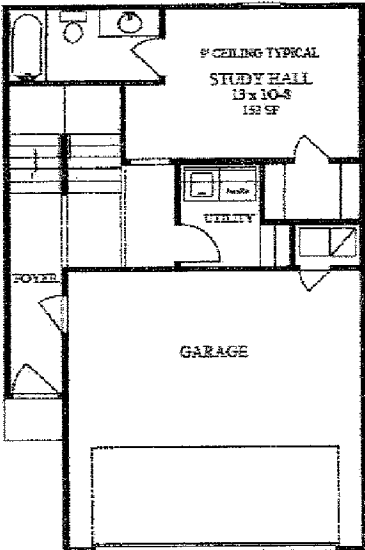

SECOND FLOOR LEVEL

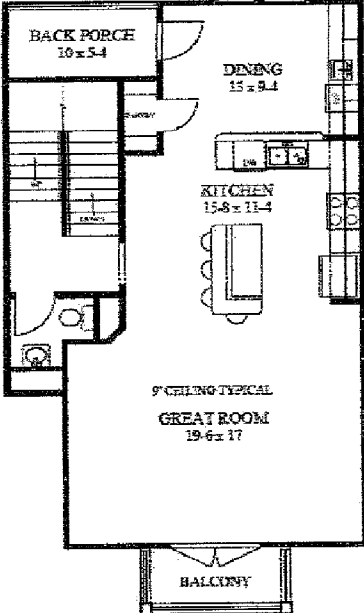

THIRD FLOOR LEVEL

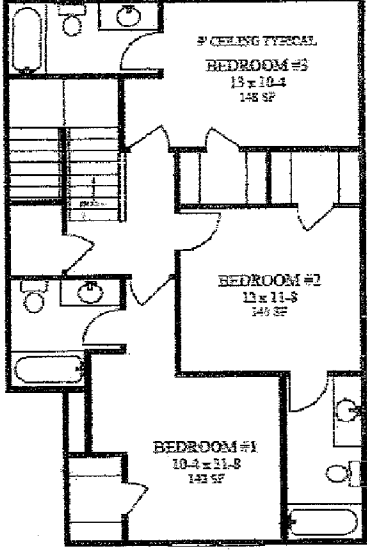

496 SF FIRST FLOOR LEVEL
841 SF SECOND FLOOR LEVEL
824 SF THIRD FLOOR LEVEL
2161 SF TOTAL CONDITIONED SPACE
400 SF GARAGE
56 SF BACK PORCH
47 SF BALCONY
11 SF FRONT PORCH

10/10/10

3

850-224-7368

www.campusblockfsu.com

Brand new student townhomes

NOW LEASING FOR
AUGUST 2013

Total of ten 4
bedroom, 4-1/2 bath
student townhomes

Reserve your unit now for
August 2013

Lease special for first two
units signed up.

\$590 per bedroom per month
with common area furnished.

- Brand new student townhomes.
- 2 blocks west of Doak Campbell.
- All units have 2 car garage and 2 car driveway.
- Alarm systems in each unit.
- Granite counter tops, stainless steel appliances, wood floors.
- Large units, units 1-5 are 2,048 sf of air conditioned space. Units 6-10 are 2,161 sf of air conditioned space.
- All units have wet bar with granite bar top, sink, mini fridge, custom cabinets and 50" flat screen TV.
- Brick paver outdoor common area, great for pre-game.

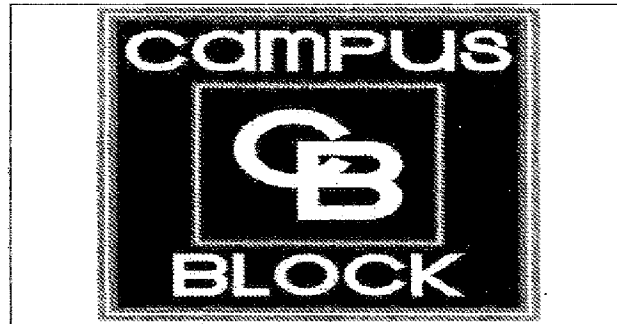

Managed by:



808 W. ST. AUGUSTINE STREET

TALLAHASSEE, FL. 32304

850.224.7368

www.campusblockfsu.com

-
- A total of 10, 4 bedroom, 4-1/2 bath townhomes.
 - Brand New, large townhomes each with over 2,055 square feet of air conditioned space.
 - Walk to stadium and FSU campus, only 2 blocks west of Doak Campbell Stadium.
 - Each townhome has its own 2-car garage and 2-car driveway.
 - Safety is paramount with dawn until dusk exterior lighting.
 - Each townhome has its own alarm system.
 - Large bedrooms each with own bathroom and walk in closet.
 - 9 foot ceilings.
 - Wood floors.
 - Stainless steel appliances.
 - Granite kitchen counter tops.
 - Full size washer and dryer in each unit.
 - Private front balcony and rear porch for each unit.
 - JELD-WEN low e-vinyl windows.
 - Fiberglass exterior doors.
 - Stainless steel appliances.
 - 30yr Architectural shingles.
 - Custom hardwood cabinets.
 - Low maintenance hardie board exterior.
 - 2" faux wood blinds.
 - Digital entry locks.
-

- Smart key entry locks on bedrooms.
- Rinnai tank-less water heater in each unit.
- Each unit has its own “wet bar” with granite counter top, sink, mini-fridge, custom cabinets and 50” flat screen on wall.

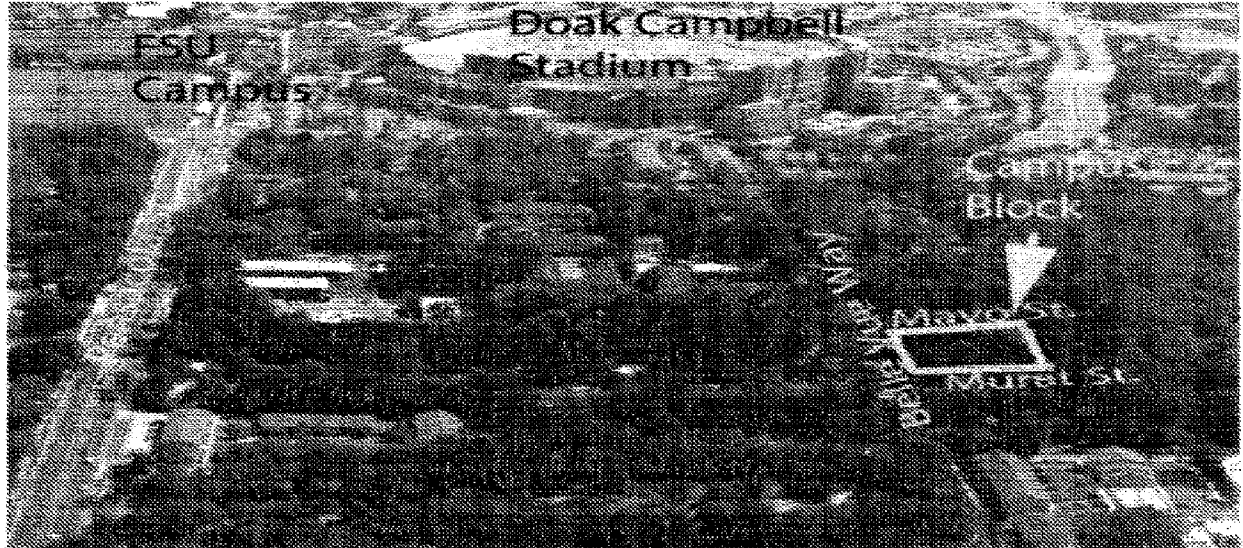

Pictures are of 1864 West www.1864west.com

A student townhome community developed by PLC Partners, LLC. 1864 West opened in August of 2012, is 100% leased and is located at 1864 Belle Vue Way. Campus Block is located on same street and will be same design as 1864 West.

Site Plan

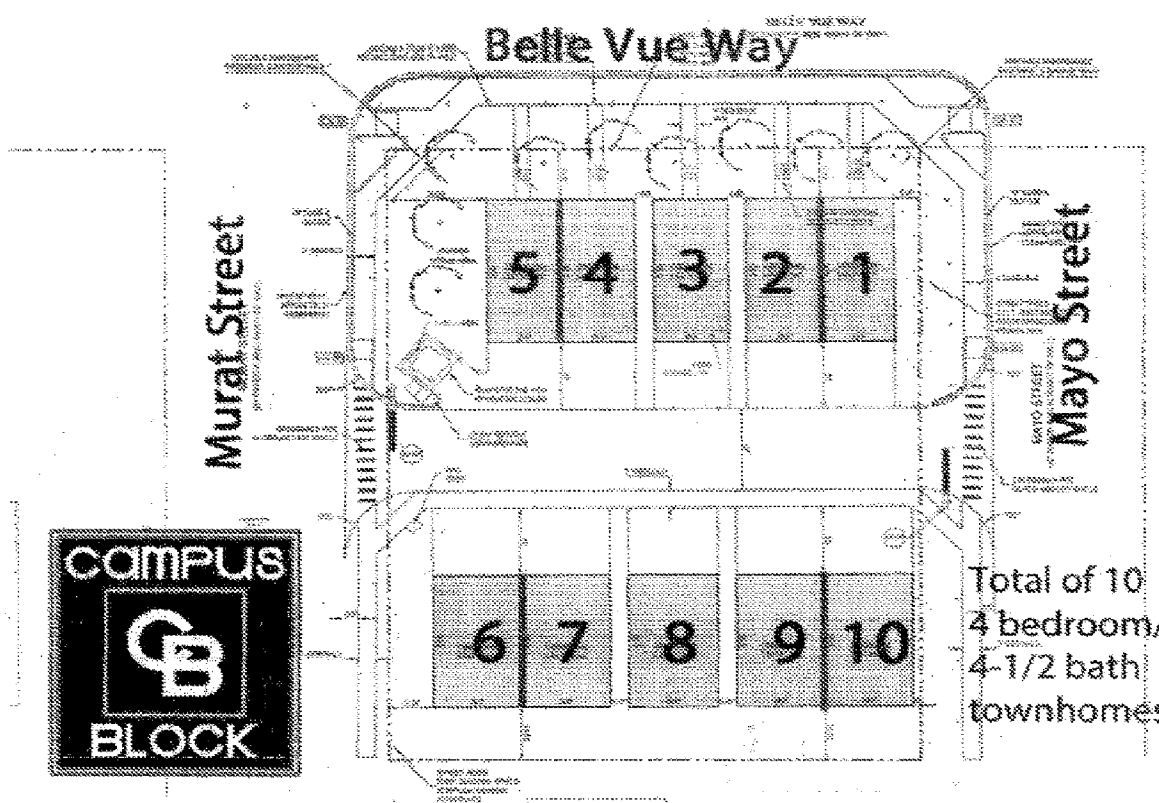

www.campusblockfsu.com

Developed by:



PLC
PARTNERS, LLC

Patrick Chisholm
President

2460 Forest Club Drive
Orlando, FL 32804

407-923-8366

pat@plcpartnersllc.com

Brokerage • Student Housing • Real Estate Investment

FIRST FLOOR LEVEL

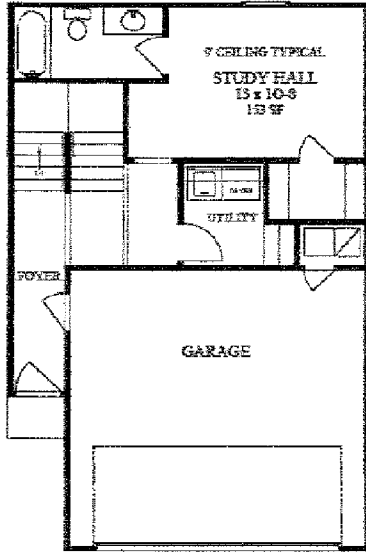

SECOND FLOOR LEVEL

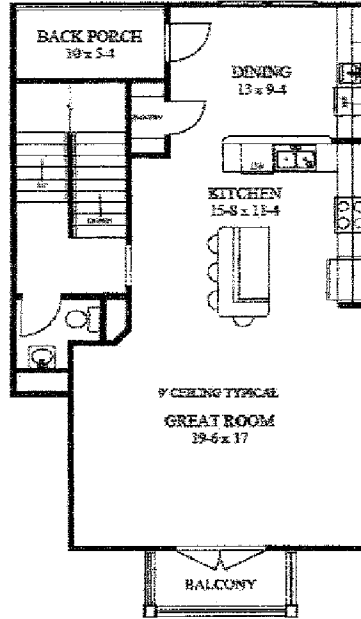

THIRD FLOOR LEVEL

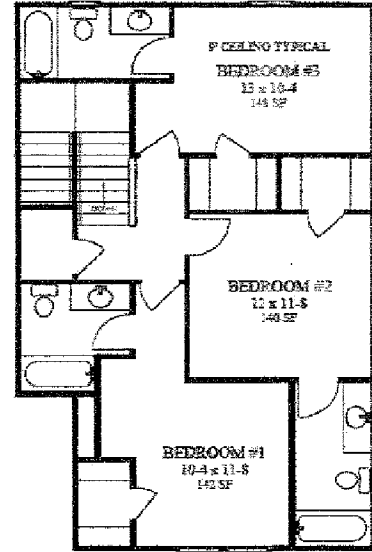

496 SF FIRST FLOOR LEVEL
 841 SF SECOND FLOOR LEVEL
 824 SF THIRD FLOOR LEVEL
 2161 SF TOTAL CONDITIONED SPACE
 400 SF GARAGE
 54 SF BACK PORCH
 47 SF BALCONY
 12 SF FRONT PORCH

47 1944

F

EXHIBIT G

CenturyLink Webmail

jimstolz@centurylink.net

± Font size :

RE: Campus Block Development: TSP120026 (300 and 304 Mayo Street)

From : Jimmy Lee <James.LeeJr@talgov.com> Wed, Feb 13, 2013 03:17 PM
Subject : RE: Campus Block Development: TSP120026 1 attachment
(300 and 304 Mayo Street)
To : 'J Stolz' <jimstolz@centurylink.net>
Cc : Brian Berry <Brian.Berry@talgov.com>, Cindy
Smith <Cynthia.Smith@talgov.com>

Mr. Stolz,

I believe your question was answered in the attachment I sent earlier today. Please let me know if you cannot open it or read it.

As you can see from the letter it states:

"The site has been approved for 10 multi-family dwelling units (30 beds) at a density of 16.94 units per acre."

It may be feasible for some 4 bedroom units to go in, but they would need to off-set them with 2 bedroom units so not to exceed the 30 beds or 10 unit limit.

Please let me know if I can be of further assistance.

Jimmy Lee, P.E.
City of Tallahassee
Land Use and Environmental Services
Growth Management Department
(850) 891-7169 Phone
(850) 891-7184 FAX
jimmy.lee@talgov.com





7781412

From: J Stolz [mailto:jimstolz@centurylink.net]
Sent: Wednesday, February 13, 2013 12:01 PM
To: Lee, Jimmy
Cc: Berry, Brian
Subject: Fwd: Campus Block Development: TSP120026 (300 and 304 Mayo Street)

Please answer the question previously posted.

Mr James Lee, PE

You stated , "As you may know this project's site plan has been approved for ten (10) three bedroom/3 bathroom units". Since you have knowledge as a reviewer of TSP120026, please answer the following question;

2. The site plan TSP120026 has been approved for (10) three bedroom / 3 bath units, is that correct?

I will be waiting for your response,

Jim Stolz

Mr. Stolz,

Thank you for forwarding your concerns to us in your letter dated January 31, 2013. As you may know this project's site plan has been approved for ten (10) three bedroom/3 bathroom units. Moore Bass Consulting has indicated to us that the developer's website is in error. I can assure you that building anything other than what is approved in the site plan as far as density is concerned, will be a violation of the site plan and would not be permissible without further review.

This project has been reviewed for compliance with Chapter 5 and Chapter 10 of the Tallahassee Development code and we have determined the project will be in compliance once the Environmental Permit has been issued. There are issues we are still working though in regards to the detailed calculations but for the most part the design will be approvable once those items are addressed.

Many of the issues in your letter can be easily resolved by a meeting or even a telephone call. I strongly recommend that we find a time to meet here in our office or on-site, if preferred, to discuss this issue in sufficient detail. It is extremely difficult to discuss this complicated development review process via email, as one response usually leads to additional questions. A conference call would also be arranged, if that is more convenient. Please contact me at 891-7169 to discuss. We take your concerns very seriously, and we look forward to establishing a constructive and efficient dialogue with you and any other concerned citizens in your area.

Jimmy Lee, P.E.
City of Tallahassee
Land Use and Environmental Services
Growth Management Department
(850) 891-7169 Phone
(850) 891-7184 FAX
jimmy.lee@talgov.com



TSP120026CampusBlockFinalApprovalLetter.pdf

541 KB

2

1944

6

STAFF USE ONLY

EXHIBIT H

		APPLICABLE CODE EDITION	FEE PD at APP	PERMIT FEES
PARKING REQ'D	<u>4</u>	<u>2010 Florida Building Code Residential</u>	Application	<u>82.40</u> PD
ZONING DIST.	<u>Ut (mmtd)</u>	CONSTR. TYPE	Driveway Application	<u>80</u>
FLOOD ZONE	<u>Y / (N)</u>	BLDG AREA	Expedited	<u>NA</u>
MFFE (if Flood Zone)	<u>-</u>	HEIGHT	Environmental	
FEMA BASE ELEV	<u>-</u>	# OF STORIES	Driveway Connection	<u>NA</u>
SUBSTANTIAL IMP	<u>Y / N</u>	# OF BEDROOMS	Building	<u>1046.88</u>
IMPERVIOUS	<u>3224</u>	# DRIVEWAY CONN	S & E Control	<u>214.08</u>
			Water & Sewer	<u>7834.00</u>
			State Surcharge	<u>32.91</u>
			Training Surcharge	<u>\$ 2.50</u>
			Other	
			Other	
			BALANCE DUE	<u>\$ 9097.97</u>

FCC120050 TSPR20026 TEM130003
 TCM120046 pending sewer

Required Review	Date of 1st Rev	Date of 2nd Rev.	Final Approval
<input checked="" type="checkbox"/> Zoning	2/20/13 [⊕] CES	2/26/13	C. Smuis ZNG
<input checked="" type="checkbox"/> Environmental	2/20/13 [⊕] CES	2/26/13	C. Smuis for JL ENV
<input type="checkbox"/> Gas			GAS
<input type="checkbox"/> Fire			FIRE
<input checked="" type="checkbox"/> Building	2/22/13 ^H SBS	2/27/13	SBS BLDG

APPLICATION STATUS, CONTACT INFORMATION & STAFF RECORDS:	
Date/Reviewer	Approved S.P. no show 3 baths. these plans show 4 full baths. PLS. Remove full bath in study.



4 15/11/23

4

EXHIBIT I

Alison Taber

From: Harden, Greg [Harold.Harden@talgov.com]
Sent: Monday, February 25, 2013 1:34 PM
To: Eddie Bass
Cc: Smith, Cindy; Lee, Jimmy; Palmer, Steven; Burnsed, Keith; Alison Taber; Pat Chisholm
Subject: RE: Campus Block (TSP120026)--Major Modification
That is correct. PSC approval is need for the tandem spaces.

From: Eddie Bass [<mailto:ebass@moorebass.com>]
Sent: Monday, February 25, 2013 1:27 PM
To: Harden, Greg
Cc: Smith, Cindy; Lee, Jimmy; Palmer, Steven; Burnsed, Keith; Alison Taber; Pat Chisholm
Subject: RE: Campus Block (TSP120026)--Major Modification

Understood, and we will proceed accordingly. As well it is my understanding that a Parking Standards Application will be required for the proposed tandem parking within the individual unit driveways□

Edward N. Bass, III, P.E.
Moore Bass Consulting, Inc.
805 North Gadsden Street
Tallahassee, Florida 32303
(850) 222-5678 Office
(850)-544-6771 Cell

From: Harden, Greg [<mailto:Harold.Harden@talgov.com>]
Sent: Monday, February 25, 2013 1:17 PM
To: Eddie Bass
Cc: Smith, Cindy; Lee, Jimmy; Palmer, Steven; Burnsed, Keith
Subject: Campus Block (TSP120026)--Major Modification

Eddie,

The Major Modification to the Campus block Type B site plan, in effect, creates a new development order with four bedroom units rather than the three bedrooms previously approved. As we discussed this morning, because this is considered a new development order, the deviations to setback and step back will need to be readdressed with the major modification application.

We look forward to working with you on this and please let us know if questions arise.

Greg Harden
Senior Planner
Land Use and Environmental Services
Growth Management Department
Phone: 850-891-7166 Fax 850-891-7184
Greg.Harden@talgov.com

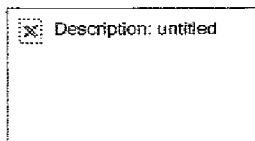

1 1948

EXHIBIT J

CITY OF TALLAHASSEE
GROWTH MANAGEMENT
RECEIPT

Reprint:

Set ID : LIYAH
RECEIPT NUMBER : R13001821
Host ID : AS

CUSTOMER : OLD FARM DEVELOPMENT, LLC

TRANSACTION DATE : 03/01/2013
TOTAL FEES : 9,023.96
TOTAL PAYMENT : 46,037.56
BALANCE : \$0.00

Transaction List:

Type	Method	Description	Amount
Payment	Check	1495	46,037.56

***** SET MEMBER *****

Set Member	Paid	Set Member	Paid
TBB130329	9,023.96	TBB130330	4,880.47
TBB130331	9,023.96	TBB130332	9,097.97
TBB130333	4,913.23	TBB130334	9,097.97

***** ACCOUNT ITEM SECTION *****

Item#	Description	Account Code	Tot Fee	Paid	Prev Pmts	Cur. Pmts
1010	BUILDING PERMIT	120-0-322001	5,418.67	5,418.67	480.00	4,938.67
1073	S&E INSPECTION	120-0-329200	1,039.72	1,039.72	.00	1,039.72
1090	A/P-STATE SURCH	120-0-202032	73.18	73.18	6.48	66.70
1095	A/P - BCALF FEE	120-0-202016	73.18	73.18	6.48	66.70
1096	TRAINING SURCHA	120-0-342501	15.00	15.00	.00	15.00
1099	STATE SURCHARGE	120-0-342501	16.21	16.21	1.44	14.77
2010	WATER TAPS	460-0-343312	6,500.00	6,500.00	.00	6,500.00
2030	WATER SYS INSID	463-0-363230	5,796.00	5,796.00	.00	5,796.00
2050	SEWER SYS INSID	503-0-363232	27,600.00	27,600.00	.00	27,600.00

Trust Account Balance: (if applicable)

L. 100000

2

EXHIBIT J

CITY OF TALLAHASSEE

COMBINATION RESIDENTIAL BUILDING, ENVIRONMENTAL, & DRIVEWAY CONNECTION PERMIT APPLICATION

HOLD C.O. by: _____

TBB #: 130382

***APPLICANT NOTICE: CHECKLIST ON PAGE 2 OR 3 MUST BE COMPLETED OR ATTACH THE APPROPRIATE CHECKLIST IF PERMIT IS FOR POOL, POOL RELINER, OR RETAINING WALL

Location: 300 Mayo St Unit #6 and 7 Zip: 32304

Street Number Street Name

Subdivision Name: _____ Lot _____ Blk _____ Unit Phase _____

Parcel I.D. No. (Tax Folio No.): 21 - 35 - 000000 - 00010

Property Owner: 29 CAMPOS Block 604E Telephone #: 407-923-8366

Mailing Address: 2460 Forest Club Dr Orlando FL 32804

Contractor License No.: C6C1505280 Telephone #: 850 591-1897 Email: RobKasper@camcos.com

Contractor & Firm Name: Old Firm Development LLC Fax #: 850 576-9177

Contractor Mailing Address: PO Box 20438 Tall. FL 32316

Architect/Engineer: TD Graham, Davis Designs Fax #: _____

A/E Mailing Address: 5792 Ansell Ferrel Rd. Tall. FL 32308

Sediment & Erosion Contact Name: Steger Contracting DEP #: 11229 Telephone #: 850 544-2502

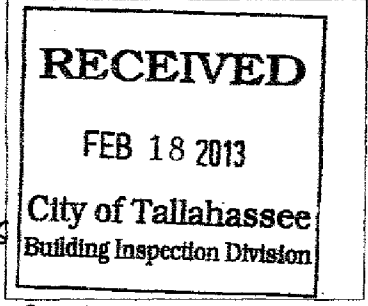

DESCRIPTION OF IMPROVEMENT	BUILDING CLASSIFICATION	TOTAL COST OF IMPROVEMENT:
01 <input checked="" type="checkbox"/> New	01 <input type="checkbox"/> One Family Detached	\$ <u>150,000.-</u>
02 <input type="checkbox"/> Addition	02 <input checked="" type="checkbox"/> Duplex	
03 <input type="checkbox"/> Alteration / Repair	12 <input type="checkbox"/> One Family Attached (___ # of attached units)	PRIVATE PROVIDER TO BE USED:
09 <input type="checkbox"/> Foundation Only	<input type="checkbox"/> Other _____	FL Statute 553.791 <input type="checkbox"/> Yes <input checked="" type="checkbox"/> No
10 <input type="checkbox"/> Pool / Pool Reliner		HAZARDOUS MATERIAL:
11 <input type="checkbox"/> Retaining Wall (separate permits required for Retaining Wall and Pool)		<input type="checkbox"/> Yes <input checked="" type="checkbox"/> No

THIS PERMIT IS FOR A NEW MASTER PLAN

THIS PERMIT HAS AN EXISTING MASTER PLAN

Permit #: _____

Address: _____

NUMBER of NEW DRIVEWAY CONNECTIONS: _____

WATER & SEWER ACCOUNT & TAPS. (MUST be completed for NEW construction)

Use Master Utility Account number (1 bill for multiple addresses)

OR Create A New Utility Account number (separate bill for each address)

Ship work orders at issuance of permit (water is needed within 2 weeks)

OR Delay shipping of work orders until: (provide date) _____

Scope of Work: Duplex

By signing below, the contractor acknowledges that products used in the construction of this building, requiring approval per FL Statutes 553.842 must have the required approval prior to installation in this building. Issuance of this building permit does not constitute approval of any product. Products that require approval per FS 553.842 are (1) panel walls, (2) exterior doors, (3) roofing products, (4) skylights, (5) windows, (6) shutters, (7) structural components, and (8) products comprising a building's envelope introduced as a result of new technology.

Contractor's Signature: [Signature] Print Name: Robert Kasper Date: 2-13-13



Growth Management Department | Building Inspection Division | Phone: (850) 891-7125 | Fax: (850) 891-0948
 Location: 435 N. Macomb Street, Tallahassee, FL 32301 | Mailing: 300 S. Adams Street, Box B-28, Tallahassee, FL 32301



2000

2

EXHIBIT J

STAFF USE ONLY

		APPLICABLE CODE EDITION	FEE'S PD at APP	PERMIT FEES
PARKING REQ'D	<u>H</u>	<u>2010 Florida Building Code, Residential</u>	Application	<u>82.40</u> PD
ZONING DIST.	<u>UT (mm td)</u>	CONSTR. TYPE	Driveway Application	<u>80</u>
FLOOD ZONE	<u>Y / N</u>	BLDG AREA	Expedited	<u>NA</u>
MFPE (if Flood Zone)	<u>-</u>	HEIGHT	Environmental	<u>-</u>
FEMA BASE ELEV	<u>-</u>	# OF STORIES	Driveway Connection	<u>NA</u>
SUBSTANTIAL IMP	<u>Y / N</u>	# OF BEDROOMS	Building	<u>1006.88</u>
IMPERVIOUS	<u>3224</u>	# DRIVEWAY CONN	S & E Control	<u>214.08</u>
			Water & Sewer	<u>7834.00</u>
			State Surcharge	<u>32.91</u>
			Training Surcharge	<u>\$2.50</u>
			Other	<u>-</u>
			Other	<u>-</u>
			BALANCE DUE	<u>\$ 9097.97</u>

TCC 120050 TSP 120026 TCM 130003
 TCM 120046 / pending sewer

Required Review	Date of 1st Rev	Date of 2nd Rev.	Final Approval
<input checked="" type="checkbox"/> Zoning	2/20/13 ^{CS}	2/26/13	C. Smoot C. Smoot ZNG
<input checked="" type="checkbox"/> Environmental	2/20/13 ^{CS}	2/26/13	C. Smoot for J.L. ENV
<input type="checkbox"/> Gas			
<input type="checkbox"/> Fire			
<input checked="" type="checkbox"/> Building	2/22/13 ^H SBT	2/27/13	SBT BLDG

APPLICATION STATUS, CONTACT INFORMATION & STAFF RECORDS:	
Date/Reviewer	



27/11/19

1

EXHIBIT J

CITY OF TALLAHASSEE
GROWTH MANAGEMENT DEPARTMENT
Building Permit

Permit# TBB130332

24 hr IVRS Inspection
Line (850) 891-1800
Fla Relay Serv. TDD 1-800-955-8771

Post this card so that it is visible from the street. This permit expires if no work is started within 6 months or if work is discontinued for 6 continuous months.

Address: 1775 BELLE VUE WAY T/LC 6 & 7

Date Issued: 03/01/2013 Imp Type: NEW Imp Class: DUPLEX

SqFt: 5,352 valuation: \$150,000 Units: 2 Occ/Type of Use: RESIDENTIAL

Subdivision: BELLE VUE MANOR Parcel#: 2135220000010 Zoning: UT Flood Zone: N

Const Type: TYPE V-B Occ Load: 0 Shell: N Threshold: N

Sprinkler: NONE Min. Fin. Floor Elev.: 0 Bike Rack: 0 Parking: 4

Owner: CAMPUS BLOCK FSU LLC PH# 407-923-8366

Sediment & Erosion Contact: STEGE, JAMES E. PH# 668-1003 Lic#: DEP11229

Contractor: OLD FARM DEVELOPMENT, LLC. PH# 850/591-1897 Lic#: CGC1505282

Conditions of Permit Issuance:
ENGINEERED FOUNDATION / UNIT 6 & 7

PAID
MAR 01 2013
City of Tallahassee
Building Inspection Division
Edition of Code: FL Bldg Code 2010

NO BUILDING CAN BE OCCUPIED PRIOR TO RECEIVING A CERTIFICATE OF OCCUPANCY.

Contractor / Applicant Signature

In addition to the requirements of this permit, there may be additional restrictions applicable to this property that may be found in the public records of this county, and there may be additional permits required from other governmental entities such as water management districts, state agencies, or federal agencies.

All contractors executing work on a project, which has a potential to create soil erosion, shall comply with City Commission Policy# 417.

If you believe this permit is unreasonable or unfairly burdens your property, you may request relief within 30 days under the Florida Land Use and Environmental Dispute Resolution Act. See City Commission Policy 414CP, Licensing & Permitting, City Hall, 300 S. Adams St., Tallahassee, FL 32301

WARNING TO OWNER: YOUR FAILURE TO RECORD A NOTICE OF COMMENCEMENT MAY RESULT IN YOUR PAYING TWICE FOR IMPROVEMENTS TO YOUR PROPERTY. A NOTICE OF COMMENCEMENT MUST BE RECORDED AND POSTED ON THE JOB SITE BEFORE THE FIRST INSPECTION. IF YOU INTEND TO OBTAIN FINANCING, CONSULT WITH YOUR LENDER OR AN ATTORNEY BEFORE RECORDING YOUR NOTICE OF COMMENCEMENT.

Building TCO	Electrical TCO	Plumbing TCO	Mechanical TCO	Gas TCO	Environmental TCO	Fire TCO
Building 900 Final	Electrical 901 Final	Plumbing 905 Final	Mechanical 903 Final	Gas Final	Environmental Final	Fire Final
Roofing 917 Final	Solar Elec Final	Solar Plumb Final	Driveway Final	Commercial Environmental Inspections MUST be scheduled with the Commercial Environmental Inspector @ (850) 891-7100		NOC on file w/City

67-10000

2

is permitted to the exterior via *means of egress* without restraint. A Condition 1 facility is permitted to be constructed as Group R.

308.4.2 Condition 2. This occupancy condition shall include buildings in which free movement is allowed from sleeping areas and any other occupied smoke compartment to one or more other smoke compartments. Egress to the exterior is impeded by locked exits.

308.4.3 Condition 3. This occupancy condition shall include buildings in which free movement is allowed within individual smoke compartments, such as within a residential unit comprised of individual *sleeping units* and group activity spaces, where egress is impeded by remote-controlled release of *means of egress* from such a smoke compartment to another smoke compartment.

308.4.4 Condition 4. This occupancy condition shall include buildings in which free movement is restricted from an occupied space. Remote-controlled release is provided to permit movement from *sleeping units*, activity spaces and other occupied areas within the smoke compartment to other smoke compartments.

SECTION 310 RESIDENTIAL GROUP R

310.1 Residential Group R. Residential Group R includes, among others, the use of a building or structure, or a portion thereof, for sleeping purposes when not classified as an Institutional Group I or when not regulated by the *Florida Building Code, Residential* in accordance with Section 101.2. Residential occupancies shall include the following:

R-1. Residential occupancies containing *sleeping units* where the occupants are primarily transient in nature, including:

Boarding houses (transient)
Hotels (transient)
Motels (transient)

Congregate living facilities (transient) with 10 or fewer occupants are permitted to comply with the construction requirements for Group R-3.

R-2. Residential occupancies containing *sleeping units* or more than two *dwelling units* where the occupants are primarily permanent in nature, including:

USE AND OCCUPANCY CLASSIFICATION

Apartment houses
Boarding houses (nontransient)
Convents
Dormitories
Fraternities and sororities
Hotels (nontransient)
Live/work units
Monasteries
Motels (nontransient)
Vacation timeshare properties

Congregate living facilities with 16 or fewer occupants are permitted to comply with the construction requirements for Group R-3.

R-3. Residential occupancies where the occupants are primarily permanent in nature and not classified as Group R-1, R-2, R-4 or I, including:

Buildings that do not contain more than two *dwelling units*.
Adult care facilities that provide accommodations for five or fewer persons of any age for less than 24 hours.
Child care facilities that provide accommodations for five or fewer persons of any age for less than 24 hours.
Congregate living facilities with 16 or fewer persons.

Adult care and child care facilities that are within a single-family home are permitted to comply with the *Florida Building Code, Residential*.

R-4. Residential occupancies shall include buildings arranged

RESIDENTIAL CARE/ASSISTED LIVING FACILITIES. A building or part thereof housing persons, on a 24-hour basis, who because of age, mental disability or other reasons, live in a supervised residential environment which provides *personal care services*. The occupants are capable of responding to an emergency situation without physical assistance from staff. This classification shall include, but not be limited to, the following: residential board and care facilities, assisted living facilities, halfway houses, group homes, congregare care facilities, social rehabilitation facilities, alcohol and drug abuse centers and convalescent facilities.

TRANSIENT. Occupancy of a *dwelling unit* or *sleeping unit* for not more than 30 days.

SECTION 311 STORAGE GROUP S

311.1 Storage Group S. Storage Group S occupancy includes, among others, the use of a building or structure, or a portion thereof, for storage that is not classified as a hazardous occupancy.

311.2 Moderate-hazard storage, Group S-1. Buildings occupied for storage uses that are not classified as Group S-2, including, but not limited to, storage of the following:

Aerosols, Levels 2 and 3
Aircraft hangar (storage and repair)

EXHIBIT K

Webmail

jimstolz@centurylink.net

Response to your e-mail of March 4, 2013 - TPK130003, TSP130009

From : Cindy Smith <Cynthia.Smith@talgov.com> Tue, Mar 05, 2013 04:24 PM
Subject : Response to your e-mail of March 4, 2013 - TPK130003, TSP130009 ✉ 1 attachment
To : jimstolz@centurylink.net

Mr. Stolz – Attached please find each of the Parking Standards Committee member’s written findings.

The parking actually does meet the minimum Code requirement. The MMTD requires .75 spaces per bedroom. Transect 5 of the MMTD allows between 65% and 100% of that number. In this case, with 40 bedrooms, the parking requirement is a range of 19.5 spaces and 30 spaces. That’s the reason for the Parking Standards request to increase the parking to 36 spaces. Visitor parking is not a requirement in Section 10-285, Table 8A of the MMTD Code.

Tandem parking is allowed for single family residential, but not permitted for multi-family. The Parking Standards Committee noted that these units are “townhouse style”, and therefore approved the allowance of tandem parking. A condition was placed on that approval to allow tandem parking with the provision that the spaces be assigned by unit and a towing contract is put in place and enforced.

I would like to assure you that all aspects of the Code will be met on this project. I would be happy to sit down with you, at your convenience, and discuss any further concerns you may have. I’m available between the hours of 7:30 and 4:30, Monday through Friday.

Sincerely,

Cindy Smith, Senior Planner
Land Use and Environmental Services Division
Growth Management Department
(850 891-7076

 **psc130003.pdf**
2 MB

4 78942



OCCUPATIONS

Chapter 481
ARCHITECTURE, INTERIOR DESIGN,
AND LANDSCAPE ARCHITECTURE

View Entire
Chapter

481.229 Exceptions; exemptions from licensure.—

(1) No person shall be required to qualify as an architect in order to make plans and specifications for, or supervise the erection, enlargement, or alteration of:

(b) Any one-family or two-family residence building, townhouse, or domestic outbuilding appurtenant to any one-family or two-family residence, regardless of cost;

Failing to properly enforce applicable fire codes or permit requirements within this state which the certificateholder knows are applicable by committing willful misconduct, gross negligence, gross misconduct, repeated negligence, or negligence resulting in a significant danger to life or property.

(6) "Architecture" means the rendering or offering to render services in connection with the design and construction of a structure or group of structures which have as their principal purpose human habitation or use, and the utilization of space within and surrounding such structures. These services include planning, providing preliminary study designs, drawings and specifications, job-site inspection, and administration of construction contracts.

481.203(7) "Townhouse" is a single-family dwelling unit not exceeding three stories in height which is constructed in a series or group of attached units with property lines separating such units.

Each townhouse shall be considered a separate building and shall be separated from adjoining townhouses by the use of separate exterior walls meeting the requirements for zero clearance from property lines as required by the type of construction and fire protection requirements; or shall be separated by a party wall; or may be separated by a single wall meeting the following requirements:

(a) Such wall shall provide not less than 2 hours of fire resistance. Plumbing, piping, ducts, or electrical or other building services shall not be installed within or through the 2-hour wall unless such materials and methods of penetration have been tested in accordance with the Standard Building Code.

(b) Such wall shall extend from the foundation to the underside of the roof sheathing, and the underside of the roof shall have at least 1 hour of fire resistance for a width not less than 4 feet on each side of the wall.

(c) Each dwelling unit sharing such wall shall be designed and constructed to maintain its structural integrity independent of the unit on the opposite side of the wall.

2

EXHIBIT K

Smith, Cindy

From: Harden, Greg
Sent: Thursday, February 28, 2013 7:25 AM
To: Smith, Cindy
Cc: Payne, Thomas; Snyder, Russell
Subject: RE: TPK130003 - Campus Block

Growth Management supports the 36 spaces for the development. Since justification for the tandem parking was not provided GM will defer to Public Works in regards to safety.

From: Snyder, Russell
Sent: Wednesday, February 27, 2013 6:59 PM
To: Smith, Cindy
Cc: Harden, Greg; Payne, Thomas
Subject: Re: TPK130003 - Campus Block

Planning supports 36 parking spaces (since 4 of the 40 will be removed from the 2d layer per Cindy's email). I will defer to PW for the tandem parking as that is a safety issue.
Russell

On Feb 27, 2013, at 3:17 PM, "Smith, Cindy" <Cynthia.Smith@talgov.com> wrote:

Parking Standards Committee Members -- I have received a request from Eddie Bass for a parking standards review for the Campus Block Development. The property is located on the south side of Belle Vue Way, between Mayo St. and Murat St. In addition, the applicant has submitted a major modification to their approved site plan to increase each of the 10 units from 3 bedrooms to 4 bedrooms. The parking required for this area is .75 spaces per bedroom. In addition, they can have as little as 65% of that number. The parking required for this development with 40 bedrooms is a range of 19.5 spaces to 30 spaces. The site plan provided shows 40 parking spaces, but four (4) of those will have to be removed because they're in the 2nd layer. In addition, tandem parking isn't allowed in multi-family developments. The applicant is also requesting that you allow them to have tandem parking. The plans have been scanned and can be viewed in WebEx.

Since the units are townhouse style, each with a 2-car garage and driveway, the tandem parking should not be an issue. In addition, I would recommend approval of the request for 40 parking spaces.

Cindy Smith

4 TPK130003

Smith, Cindy

From: Snyder, Russell
Sent: Wednesday, February 27, 2013 6:59 PM
To: Smith, Cindy
Cc: Harden, Greg; Payne, Thomas
Subject: Re: TPK130003 - Campus Block

Planning supports 36 parking spaces (since 4 of the 40 will be removed from the 2d layer per Cindy's email). I will defer to PW for the tandem parking as that is a safety issue.

Russell

On Feb 27, 2013, at 3:17 PM, "Smith, Cindy" <Cynthia.Smith@taigov.com> wrote:

Parking Standards Committee Members – I have received a request from Eddie Bass for a parking standards review for the Campus Block Development. The property is located on the south side of Belle Vue Way, between Mayo St. and Murat St. In addition, the applicant has submitted a major modification to their approved site plan to increase each of the 10 units from 3 bedrooms to 4 bedrooms. The parking required for this area is .75 spaces per bedroom. In addition, they can have as little as 65% of that number. The parking required for this development with 40 bedrooms is a range of 19.5 spaces to 30 spaces. The site plan provided shows 40 parking spaces, but four (4) of those will have to be removed because they're in the 2nd layer. In addition, tandem parking isn't allowed in multi-family developments. The applicant is also requesting that you allow them to have tandem parking. The plans have been scanned and can be viewed in WebEx.

Since the units are townhouse style, each with a 2-car garage and driveway, the tandem parking should not be an issue. In addition, I would recommend approval of the request for 40 parking spaces.

Cindy Smith

Webmail

jimstolz@centurylink.net

TPK130003, TSP120026, and TSP 130009 major modification for Campus Block Development: (300 and 304 Mayo Street)

From : J Stolz <jimstolz@centurylink.net>

Thu, Feb 28, 2013 02:37 PM

Subject : TPK130003, TSP120026, and TSP 130009 major modification for Campus Block Development: (300 and 304 Mayo Street)mayo
1 attachment**To :** Harold Harden <Harold.Harden@talgov.com>**Cc :** Keith Burnsed <Keith.Burnsed@talgov.com>, Dwight Arnold <Dwight.Arnold@talgov.com>, Jimmy Lee <James.LeeJr@talgov.com>, Steven Palmer <Steven.Palmer@talgov.com>, Gabe Menendez <Gabriel.Menendez@talgov.com>, cindy <cindy.smith@talgov.com>

Mr. Harden,

Thank you for your reply. Please forward the following comments and questions to the Parking Standards Committee reviewing TPK130003 and include them in the public record files listed above.

The redevelopment of Campus Block with its proposed parking scheme is inadequate. Review of Campus Block TSP120026 had been based on the applicant's submittal that 30 tenants will occupy the redeveloped property. Based on the engineer of record, 20 parking spaces had been proposed for 30 tenants.

TSP130009, a major modification of TSP 1200026, now requests the same 20 parking spaces for 40 tenants.

The proposed TSP130009 major modification proposed parking is inadequate and does not meet all applicable Codes.

The applicant wishes to provide just 20 parking spaces for 40 individual tenants and their guests, that does not meet *Article IV Table 8A Code's* on-site parking requirements. Division 4 of the Code appears to also have been completely ignored and proposes the complete elimination of all current legal on-street perimeter vehicle overflow parking on all three redevelopment road frontages. *Section 10-284.5 Parking Location Standards (b) (1) states: On-street parking shall be provided on all streets with*

adequate public right of way (Sec -285 Table 2A). Not only is street parking not being provided but, all the existing legal street parking has been eliminated.

The proposed Campus Block parking scheme will without doubt create Life, Safety and Health Hazards for the Campus Block residents and for the surrounding Mayo, Murat, and Belle View residents and for the general public that will be in the area. Life safety issues must be must be properly addressed.

The 40 bedroom proposed Campus Block parking scheme now under review will likely result in MMTD road lane blockage, public local road lane blockage, dumpster blockage, illegal parking on sidewalks, illegal parking in the road, illegal parking on other private property, illegal driveway blockage, emergency vehicle blockage, vehicle line of sight impedance and an overall chaotic mix of bicycles, skateboards, pedestrians and vehicles clearly resulting in Life Safety and Health Hazards. Public safety requires that the parking design reflect the actual use and the code specifically requires for this redevelopment that more parking spaces be on-site and on-street.

What is the public good if someone gets injured, what could be used as an argument to defend the variance approval of any minimum code safety standards?

There is no hardship stated or otherwise for not adhering to just the minimum code standards. As a matter of Life Safety, the Parking Standards Committee must reject the proposed parking variance request and require the bare minimum Code requirements be applied to the Campus Block Redevelopment project.

Thank you,

Jim Stolz, affected party

Thank you Mr. Lee,

I just have a few more questions. Sorry if this seems tedious, but it would be far more prudent to address these issues before any damage occurs.

Stormwater flooding from the proposed Campus Block revelopment remains a concern due to the altering of existing site conditions by the redevelopment. I have reviewed the file and drainage basin maps do not appear to be included with the TEM 130003 documents. Does the approved TEM 130003 permit include all uphill drainage basins in the approved version stormwater drainage calculations?

The blocking of the existing Mayo Street west edge stormwater swale by the new sidewalk on the southeast end of the Campus Block redevelopment at Mayo Street alters the existing stormwater

flow, has that been resolved?

It seems that the existing west edge Mayo Street stormwater swale blockage could have easily been averted if *Section 10-284.5 Parking Location Standards (b) (1) On-street parking shall be provided on all streets with adequate public right of way (Sec -285 Table 2A)* of Division 4 of the Code was applied.

Why was this 10-284.5 (b) (1) shall issue not incorporated in the redevelopment plans and when was the public hearing held for a variance request?

Lack of parking remains an issue. Was the primary purpose of omitting all existing and new on-street parking to limit the stormwater runoff caused by providing the code required on-street parking? Can pavers or less redevelopment intensity be used to reduce the runoff loading?

In regards to your previous email, *"Thank you for forwarding your concerns to us in your letter dated January 31, 2013. As you may know this project's site plan has been approved for ten (10) three bedroom/3 bathroom units. Moore Bass Consulting has indicated to us that the developer's website is in error. I can assure you that building anything other than what is approved in the site plan as far as density is concerned, will be a violation of the site plan and would not be permissible without further review. "* Has the applicant or developer made any request for further review to increase the Campus Block approved development to (10) 4 bedroom /4.5 bathroom units? How will parking be addressed?

I am waiting on a response for the other questions posed in my February 1, 2013 letter in regards to the altering of the subsoil conditions that is common under the existing 308, 312, 316 residences and the proposed 304 drainage swale excavation. When can I expect that response?

Thank you for your public service,

Jim Stolz
affected party

Mr. Stolz,

The question regarding the sanitary sewer loading is best answered by Underground Utilities so I will allow Brian Berry to answer this question.

In regards to the request for stormwater calculations you can request this information at:

<http://www.talgov.com/growth/growth-recordrequest.aspx>

For you information the Environmental Permit number is TEM130003.

Please give me a call if you have any additional questions.

Jimmy Lee, P.E.
City of Tallahassee
Land Use and Environmental Services
Growth Management Department
(850) 891-7169 Phone
(850) 891-7184 FAX
jimmy.lee@talgov.com



From: J Stolz [mailto:jimstolz@centurylink.net]
Sent: Monday, February 18, 2013 12:19 PM
To: Lee, Jimmy
Cc: Berry, Brian; Smith, Cindy; Palmer, Steven
Subject: Re: Campus Block Development: TSP120026 (300 and 304 Mayo Street)

Mr James Lee P.E.,

Thank you for your response and offer of further assistance. There may still be outstanding issues that I am not yet comfortable with in regards to this project and I do need your assistance. My January 31, 2013 letter you received explained my concerns in detail. Now that the Campus Block Development had been approved, I can only rely on the comfort of that through their approval, the City has certified that all those concerns have been properly addressed.

I have read your answers and I do understand the overall code allowable 10 unit 30 bed density, but it remains unclear to me as to the actual number of UPC Drainage Fixture Units Values and system coefficient that have been approved. As you know any overloading of the existing Mayo Street sewer line will cause both harm and damage to

4 7:54:22
K

Smith, Cindy

From: Harden, Greg
Sent: Friday, March 08, 2013 1:47 PM
To: Smith, Cindy
Subject: FW: TPK130003 for Campus Block and TSP130009, major modification of TSP120026 (10) unit multifamily redevelopment

FYI

From: Shuffler, Gail
Sent: Friday, March 08, 2013 1:33 PM
To: 'J Stolz'
Cc: Burnsed, Keith; Palmer, Steven; Harden, Greg; Menendez, Gabe; Arnold, Dwight; Tedder, Wayne
Subject: RE: TPK130003 for Campus Block and TSP130009, major modification of TSP120026 (10) unit multifamily redevelopment

Good Morning and thank you for your email. While we do not dismiss your concerns for public safety and welfare, we believe that this matter has had proper scrutiny and examination by several departments of the City. By state law, public entities in Florida are civilly immune for their planning decisions.

I did not understand what the public safety issue was that you referenced and while we are immune, I would like to know the nature of the specific safety issue you have identified and why you think it is problematic.

Thank you again for your concerns.

Gail Shuffler
Risk Manager
Division of Risk Management
300 S. Adams Street, Box A-34
Tallahassee, FL 32301

From: J Stolz [mailto:jinstolz@centurylink.net]
Sent: Thursday, March 07, 2013 8:20 AM
To: Shuffler, Gail
Subject: Fwd: TPK130003 for Campus Block and TSP130009, major modification of TSP120026 (10) unit multifamily redevelopment

Hi Gail,

The Parking Standards Committee (Thomas Payne, Greg Harden and Russel Synder) appear to have diverted from the Code requirements to make their own standards for certain projects. Campus Block TSP120006 is a ten unit one 0.59 acre lot multifamily redevelopment, yet they apply exception and call the development single family? There has been no variance request made, yet exceptions to the Code have been approved.

I believe these actions to put the City at Risk in regards to the Public Safety and Welfare. Attached please find a more detailed explanation of the liability being created when it could easily be avoided if the Code was simply followed and implemented.

Please look into this matter. Something should be done before the risk becomes permanent. The DRC meets April 8 to address other major modifications to this development and the Director of Planning and the Public Works Director oversee the Parking Standards Committee.

Thank you,

Jim Stolz

Mr. Harden,

RE: Campus Block (10) unit multi-family redevelopment

Ms. Smith did reply to question #1 regarding multi-family MMTD parking requirements, but failed to address the March 4, 2013 email items #2, #3 or #4.

Ms. Smith specifically stated in her response;

"Tandem parking is allowed for single family residential, but not permitted for multi-family. The Parking Standards Committee noted that these units are "townhouse style" and therefore approved the allowance of tandem parking".

Please confirm or deny: The PSC did approve a deviation of the Code allowing tandem parking for the Campus Block multi-family redevelopment.

Jim Stolz
affected party

Mr. Stolz:

Cindy Smith is our staff coordinator for the Parking Standards Committee and Cindy will answers to your questions.

From: J Stolz [mailto:jimstolz@centurylink.net]
Sent: Monday, March 04, 2013 8:36 PM
To: Harden, Greg
Cc: Burns, Keith; Paimer, Steven; Menendez, Gabe; Arnold, Dwight; Tedder, Wayne
Subject: Re: TPK130003 for Campus Block and TSP130009, major modification of TSP126026

Mr Harden,

RE: Public Records Request

Please provide a copy of the following public record documents or provide the specific public file location supporting each item listed below.

1. A complete application for Parking Standards Committee review was submitted on or about February 27, 2013 and is in the public file. The applicant's stated reason for their parking requirement deviation was "aesthetics" for increasing the previously approved 30 bedroom, 20 surface space parking layout to a 40 bedroom with the same 20 surface space parking layout. The occupancy numbers were increased from 30 to 40 tenants, yet the 20 surface parking space layout remained the same at 20 spaces. 40 Tenant occupancy requires a

March 31, 2013

PUBLIC RECORD INQUIRY FOR PENDING REQUESTED APPROVAL OF TSP130009

REFERENCED TO THE PUBLIC RECORDS OF: TSP 120026, TPK 130003, TEM130003, TBB122411, TBB124410, TBB 130329, TBB 130330, TBB 130331, TBB 130332, TBB 130333, TBB 130334, TCM130008, TCM120046

Please Confirm or Deny the following 57 review inquiries as they relate to the above referenced Public Record Submittals and as they relate to the proposed Campus Block Redevelopment proposed removal of two single family dwellings on 0.59 acre to add a 40 unrelated person apartment complex on 0.59 acre.

Mr. Harden, Mr. Thomas Payne, Russell Snyder, Gabe Menendez,

1. The Engineer of Record's (EOR's) November 8, 2012, TSP120026 Narrative requests the review of the Campus Block Redevelopment based upon the applicant's submitted for (10) three bedroom, three bath units.
2. On January 28, 2012, TSP120026, during the DRC hearing, the Campus Block *site plan had been approved for 10 multi-family dwelling units (30 beds) at a density of 16.94 units per acre.*
3. On or about February 26, 2013, the Engineer of Record (EOR) requested a Major Modification approval for 10 dwelling units with a proposed new occupant load. TSP130009 requests a Major Modification approval for (10) 4 bedroom, 40 tenant occupancy.
4. Review by the Parking Standards Committee (PSC) was listed as a requirement.
5. A complete application for Parking Standards Committee review was submitted on or about the afternoon of February 27, 2013 and is in the public file.
6. The PSC review is based on the current Code in place at the time of the requested review.
7. The applicant's stated required reason for their parking requirement deviation was "aesthetics" for increasing the previously approved 30 bedroom occupancy, 20 surface space parking layout to a 40 bedroom occupancy with no modification to the previously approved 20 surface space parking layout.
8. The proposed Major Modification requests the redevelopment multifamily Campus Block Apartments occupancy numbers to be increased from 30 to 40 Tenants occupancy.
9. The 20 surface parking space layout remained the same at 20 surface parking spaces.
10. Section 10-358's minimum off-street parking space standards require 30 on-site surface parking spaces, and 5 visitor on-site surface parking spaces.
11. No handicap parking spaces have been provided on TPK130003.
12. No on-site or off-site visitor parking spaces have been provided on TPK130003.
13. The 40 Tenant occupancy load is based upon the individual rental of bedroom units to 40 individual tenants.
14. 40 individual tenants renting rooms and sharing a common area are not classified as "family" by Code.
15. Code requires that the resulting redevelopment shall not be detrimental to the public good or to the surrounding properties.
16. Section 10-358 is not being applied to the MMTD district redevelopment.

X 11/14/13

17. Transect 5 of the MMTD allows between 65% and 100% reduction of the required parking for *new development* projects.
18. Transect 5 of the MMTD allows a 25% reduction of the required parking for *redevelopment* projects.
19. Campus Block Redevelopment is located in Transect 5 of the MMTD and is a redevelopment from two single family dwelling units to ten, four bedroom multifamily apartment units with 40 bedrooms leased to individual tenants.
20. Section 10-285 Table 8A requires a minimum of 30 surface on-site and off-site parking spaces with a further allowable 25% redevelopment reduction if it is determined that the further reduction is not detrimental to the public good or safety.
21. Tandem parking is allowed for single family residential, but not permitted for multifamily development or multifamily redevelopment.
22. Tandem parking is not permitted by Code for multifamily redevelopment.
23. Campus Block multifamily Redevelopment does not meet the Code minimum parking standards.
24. The Parking Standards Committee noted that these units (Campus Block) are "townhouse style" and therefore approved the allowance of multifamily tandem parking.
25. PSC approved Tandem parking with parking units located inside garages with access being blocked by the 20 single depth surface area parking spaces.
26. 40 individual tenants will not likely have the keys to their roommates' vehicles of those sharing the common space of the Campus Block, 4 individual bedroom apartments.
27. Parking where ever they will create a hazard by blocking emergency vehicle access.
28. The Parking Standards Committee members must affirm that the public good is being served through their approval or must deny the application request.
29. The Parking Standards Committee members reviewed all TPK130003 submittals and comments prior to the issuing of the March 1, 2013 Approval letter.
30. Each Parking Standards Committee member's written findings are submitted for the TPK130003 March 1, 2013 Approval and are placed on file in public record.
31. Inadequate surface parking that does not meet the minimum Code requirements has the potential to create a pedestrian / vehicle conflict causing Life Safety Hazards.
32. The Parking Standards Committee members are aware of the 1864 West Redevelopment project cited as a parking example by the EOR.
33. The Parking Standards Committee members are aware of the 1864 West Redevelopment multifamily project is (11) 4 bedroom occupied units built in 2011 on 0.91 acres.
34. The Parking Standards Committee members have been made aware of the parking issues at 1864 West Redevelopment prior to the March 1, 2013 approval of TPK130003.
35. Parking that does not meet the minimum Code requirements requires a formal deviation or variance request from the Code requirements and must be justified for allowing any deviance from the public good.
36. The public file indicates that TPK130003 has been approved March 1, 2013 for the same 20 surface parking spaces although there was a requested 25% increase in occupancy.
37. The Parking Standards Committee approval of TPK130003 was required for the TSP130009 Site Plan Major Modification to proceed.
38. The Parking Standards Committee approved TPK130003 using tandem parking.
39. Parking Standards Committee (PSC) has the authority to establish the precedence that, single tier depth exterior surface parking will now be allowed to include a stacked

interior garage parking space in the MMTD under the new Code classification of "tandem parking" for all future multifamily apartment redevelopments.

40. PSC has the authority to establish the precedence to allow for the complete elimination of all required Code on-street parking requirements without issuing a variance.
41. PSC has the authority to establish the precedence to allow the complete waiver to not provide any handicap parking for a 40 bed apartment redevelopment.
42. PSC has the authority to establish the precedence as to allow the complete waiver for not providing any visitor parking on-site or off-site.
43. PSC has the authority to approve without a variance waiver and without public review to allow that all adjoining existing on-street parking to be completely eliminated and that no new on-street parking be added, specifically as it applies to:
{Division 4 Downtown Overlay Regulating Plan and Multi-Modal Transportation District (MMTD) Standards, Sec. 10-280.2 Applicability (b) Provisions of this Code are activated by "shall" when required....; AND, Division 4 Downtown Overlay Regulating Plan and Multi-Modal Transportation District (MMTD) Standards; Sec. 10-284.5 Parking Location Standards (b) On-street parking General to zones T3, T4, T5 and Downtown overlay. On-street parking shall be provided on all streets with adequate public right of way (Section 10-285, Table 2A). }
44. Campus Block Redevelopment has 504' (+/-) of direct road frontage on Murat Street, Belle View Way and Mayo Street all with adequate public right of way.
45. On-street parking requires that the parking spaces be paved.
46. Paved parking requires that the storm water runoff be figured into the stormwater calculations.
47. The EOR choice in placement of unit footprints on the 0.59 acre parcel requires that the redevelopment's stormwater system be placed outside of the property line of the Campus Block Redevelopment in the public right of way.
48. Campus Block is using the existing public right of way areas on Mayo Street for their private stormwater conveyance system.
49. Campus Block Redevelopment eliminates all the previous public right of way parking.
50. Street parking could be incorporated in the Campus Block Redevelopment project.
51. Campus Block will benefit financially from the option of not providing street parking.
52. The Campus Block Redevelopments' elimination of all street parking is based upon the best interest for the public good.
53. As the Development Review Managers and under the direction of a Florida Registered Professional Engineer you have the responsibility to review the Campus Block parking proposal.
54. As the Development Review Manager and under the direction of a Florida Registered Professional Engineer you have the responsibility to determine if the Campus Block parking proposal is in the best interest of the public.
55. As the Development Review Managers, the PSC has the authority to approve the Campus Block Mayo Street if it meets minimum parking requirements.
56. The resulting redevelopment shall not be detrimental to the public good or to the surrounding properties.
57. Through said approval of the Campus Block parking you thereby certify that you see no potential harm or damage will occur to any persons or property by such approval.

1. 1994

2

1994

APPLICATION CHECKLIST

For ALL Construction, provide the following: (for Alteration/Repairs also see Pg.3)

	Applicant	Staff, Initials
1. Completed Permit Application (signed by Contractor)	_____	<i>JFB</i>
2. Owners Affidavit (signed by Owner, designating Contractor as Agent, and notarized)	_____	<i>JFB</i>
3. Disclosure Statement (signed by owner & notarized): Required if Owner is acting as their own Contractor	_____	_____
4. Affidavit of Occupancy (signed by Owner and notarized)	_____	<i>Web</i>
5. Florida Lien Law form (signed by Owner): Required If the contractor and owner are the same	_____	_____
6. Certified copy of recorded Notice of Commencement, submitted @ appl:Y/N • Required if cost of improvement is greater than \$2500.00 AND Required to be on job-site AND in permit file by first inspection	_____	_____

For NEW, ADDITION, SHEDS AND UTILITY BUILDINGS, also provide the following:

7. Two (2) Sets of Construction Plans (1 Set/Master Plan) each including: (ALL Aluminum Structures require plans to be engineered, signed & sealed) • Floor Plan - 1/4" scale • Elevations (ALL views of structure) • Foundation Plan or Floor Framing Plan • Wall Section (s) • Roof Plan • Two (2) Gas Diagrams (if >2,500 sq. ft. heated and cooled) • Manufactures truss layout • Fire Resistant Framing Plan, if applicable	_____	<i>JFB</i>
8. Two (2) Engineered Wind Analysis per Florida Bldg Code (signed and sealed by Engineer) • Required IF any of the following apply: Structure is over 400 sq ft, openings w/in 3' of a corner, or any 2 story structure • Engineer must have subdivision name, lot and block or complete address • If submittal is for a new master plan 3 sets required, 2 sets for existing	_____	<i>JFB</i>
9. Environmental information required per Sections 5-56(2) & 5-84(o) of the TLDC includes: • SITE PLAN: Two (2) copies drawn to an engineering scale to fit on 8.5" x 11", 8.5" x 14" or 11" x 17" size paper, to include the following information • Property located on FIRM Flood Zone "A" will require a 100-year flood elevation determination letter prepared by a Florida registered professional engineer. A. Street name, lot dimensions, setback dimensions, north arrow, show all easements & restrictions; B. Show location, size and CPZ of all protected trees with an indication of whether they are to be removed or to remain. Removal of protected trees will require a mitigation plan. Protected trees are as follows: • Lots for single-family structures- trees greater than 36 DBH; • Lots for two or three family structures- trees greater than 12" DBH & 4" in lot perimeter zone C. Show the limits of clearing & location for placement of all sediment & erosion control measures D. Show all existing and proposed structures labeled accordingly E. Show existing and proposed two-foot contour lines labeled accordingly F. Show all grading or other methods of stormwater conveyance to an approved stormwater management facility or off site conveyance. G. Show Finished Floor Elevation	_____	<i>JFB</i>
10. 2010 Florida Building Code, Energy Conservation Form 402 or 405 (signed by the Preparer and Owner/Agent)	_____	<i>JFB</i>
11. EPL Display Card (signed by Builder with date and address of home completed on card)	_____	<i>JFB</i>
12. Manual J Form- HVAC load sizing summary for residential signed by preparer	_____	<i>JFB</i>
13. Soil Test, Engineer shall sign & seal & state subdivision name, lot & block or complete address • Required for New Construction or when Addition is > than 400 square feet • Pipe Clay, Site Fill or Old Fill, all require a Special Foundation OR • Letter signed, sealed & dated from Soils Engineer stating "Special Foundation Not Required"	_____	<i>JFB</i>
14. Completed Driveway Connection Application • Required if new driveway connection is to be installed	_____	_____

Not Signed



M 11/14/22

M



Land Use Planning • Engineering Design • Environmental Permitting • Landscape Architecture • Surveying

EXHIBIT N

**Major Modification Narrative
To Approved Site Plan TSP120026
for
Campus Block Apartments**

Parcel ID #21-35-22-000-001-0
MBC #2398.001/12-161

February 27, 2013

The major modification request for the referenced project is being submitted to modify the site plan to include four (4) bedrooms per unit, increased from the 3 bedrooms per unit approved prior as part of Type 'B' Site Plan TSP 120026.

The proposed modification includes no changes to the prior approved geometry plan, grading plan or site circulation plan. The modification does require the Utility Plan to now include a dedicated fire main, and associated fire sprinkler services to the individual units.

All prior approved deviations have been filed for re-consideration by the Development Review Committee as part of the Major Modification. A Parking Standards Application has also been submitted as part of the Major Modification to allow tandem parking to serve the individual units.

All other prior aspects not specifically mentioned above remain, including the intention of off-site connection to the Regional SWMF.

EXHIBIT 10

Certificate Number: TCM120046
Date Issued: 02/01/2013
Expiration Date: 01/28/2016

CITY OF TALLAHASSEE
CERTIFICATE OF CONCURRENENCY

Applicant: CAMPUS BLOCK FSU LLC
Owner: CAMPUS BLOCK FSU LLC
Project Name: CAMPUS BLOCK
Project Location: 300 & 304 MAYO STREET

PARCEL I.D. NUMBER(S):
21-35-22-000-0010
21-35-22-000-0020
300 MAYO ST T/LC

Type of Land Use:	Amount:	Sq. Ft./# of Units:
Residential-Apartment	10	DU

COMMENTS: 10 du / 30 beds, replaces 2 existing single fam du

Your concurrency has been obligated through the expiration date shown above. After that date, if the infrastructure for your subdivision has not been installed, or a building permit issued, the project will be considered withdrawn. In order to reinstate the project, a new application and fees must be submitted.

This certificate is issued pursuant to City of Tallahassee Ordinance Number 90-0-0080AA. This certificate certifies that the development with the land use densities and intensities specified at the above location will have adequate infrastructure capacity reserved for water, sewer, solid waste, stormwater, parks, transit and roads to serve the needs of the development until the expiration date of this permit. This permit in no way gives the proposed development any final authorization to develop, nor does it absolve the applicant from fulfilling the requirements of any Federal, State, County, or City laws or regulations related to land use or land development.

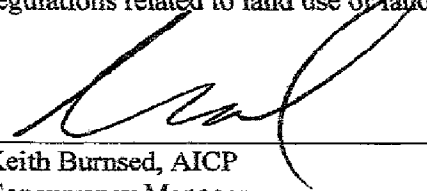

Keith Burnsed, AICP
Concurrency Manager

02/01/2013
Date

11 10/11/2020

0

EXHIBIT P

1775 Belle Vue Way
#809-9+10

THIS LABEL IS NOT
VALID FOR RETURN
PURPOSES

REVISION NOTE:
 1. THE FOUNDATION DESIGN IS BASED ON THE ASSUMPTIONS LISTED ON SHEET 100-1. THE DESIGNER IS NOT RESPONSIBLE FOR THE ACCURACY OF THE INFORMATION PROVIDED HEREIN.

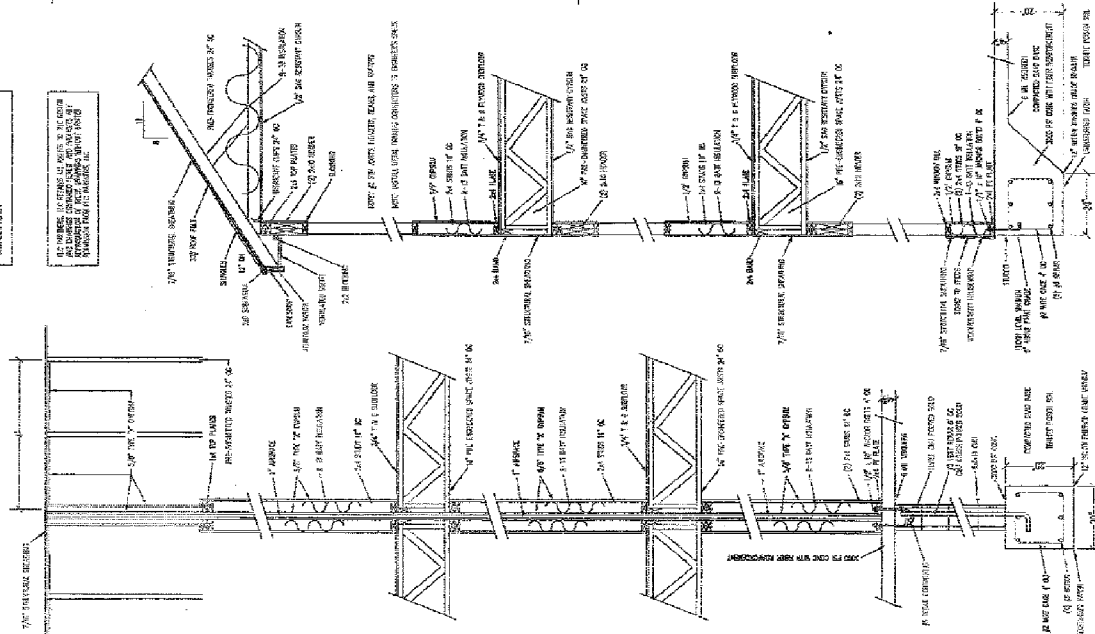

(A) TYPICAL WALL SECTION
 SCALE: 3/4" = 1'-0"

(B) PARTY WALL SECTION
 SCALE: 3/4" = 1'-0"

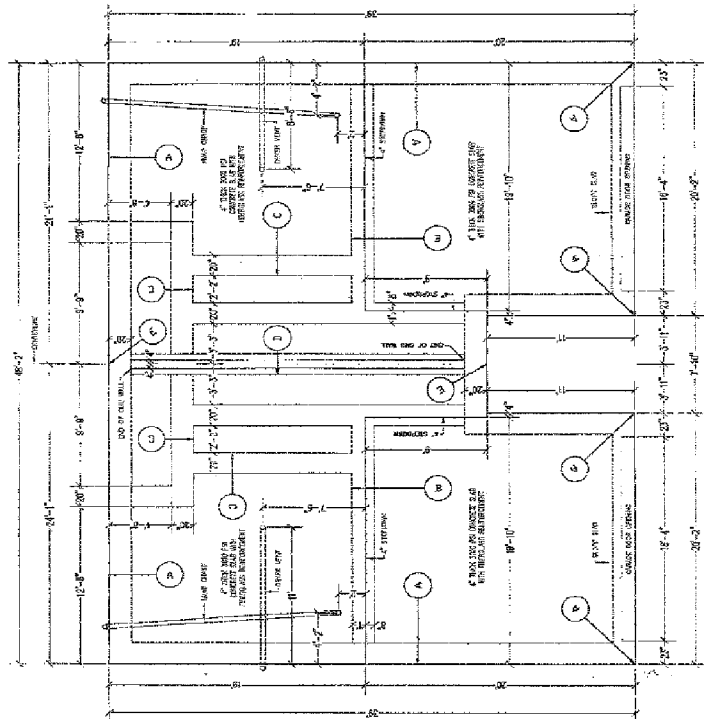

(C) INTERIOR FOOTING
 SCALE: 3/4" = 1'-0"

(D) ALTERNATE FOUNDATION SECTION
 SCALE: 3/4" = 1'-0"

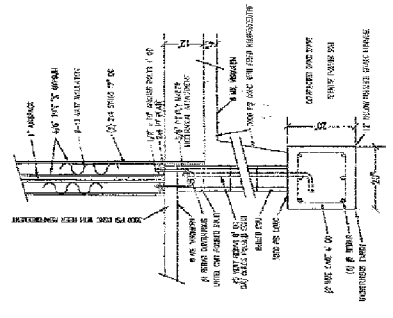

(E) ALTERNATE PARTY WALL SECTION
 SCALE: 3/4" = 1'-0"

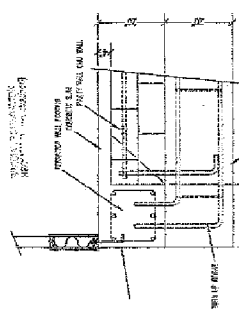

(F) PERIMETER AND PARTY WALL FOOTING CONNECTION DETAIL
 SCALE: 3/4" = 1'-0"

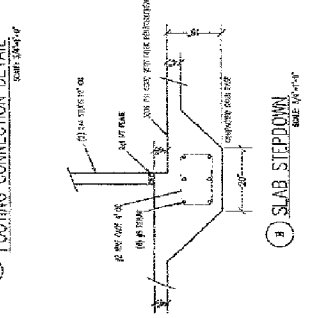

(G) SLAB STEPDOWN
 SCALE: 3/4" = 1'-0"

Oasis Designs FOUNDATION PLAN
 2022 Arred Road, Suite 100
 Tallahassee, FL 32309
 (904) 688-3115
 info@oasisdesigns.com
 www.oasisdesigns.com

SEE NUMBER OF PAGES AND NOTES TO BE SHOWN
 ON EACH DRAWING. THIS DRAWING IS TO BE
 CONSIDERED A PART OF THE CONTRACT DOCUMENTS.
 REVISIONS SHALL BE SHOWN AS FOLLOWS:

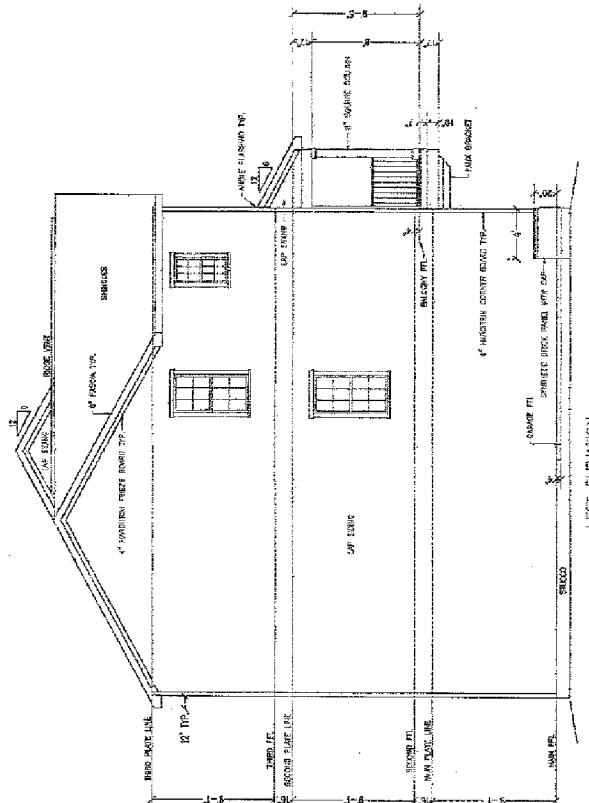

LEFT ELEVATION

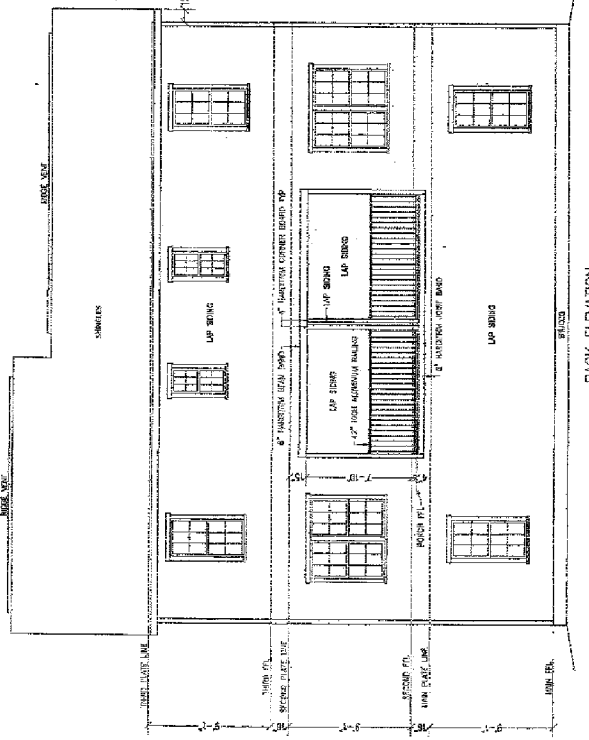

BACK ELEVATION

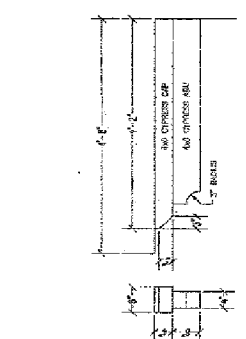

FAUX BRACKET DETAIL

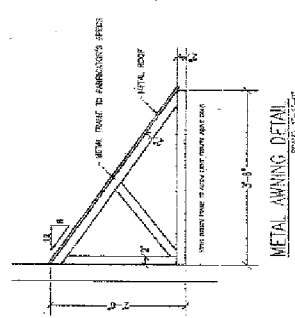

METAL AWNING DETAIL

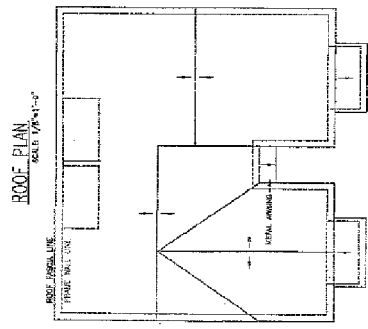

ROOF PLAN

NOTE: THESE NOTES APPLY TO ALL SHEETS. SEE THE PROJECT ARCHITECT'S MANUAL FOR MORE INFORMATION. ALL WORK SHALL BE DONE IN ACCORDANCE WITH THE LATEST EDITIONS OF THE INTERNATIONAL BUILDING CODES AND ALL APPLICABLE LOCAL, STATE AND FEDERAL CODES.

Oasis Designs 5902 Amed Road Tallahassee, FL 32309 (850) 668-3111 www.OasisDesign.com	ELEVATIONS
	SCALE: 1/8" = 1'-0" SHEET: 16 & 17 DATE: 02/27/22 NAME: CAMERON BROS. 16 & 17 (OR: 16 & 17)

ALL DIMENSIONS UNLESS OTHERWISE NOTED TO THE CONTRARY SHALL BE IN FEET AND INCHES. DIMENSIONS ARE GIVEN IN DECIMALS OF FEET AND INCHES. DIMENSIONS ARE GIVEN IN DECIMALS OF FEET AND INCHES.

UNIT #7 (#10) THIRD FLOOR LEVEL UNIT #6 (#9)

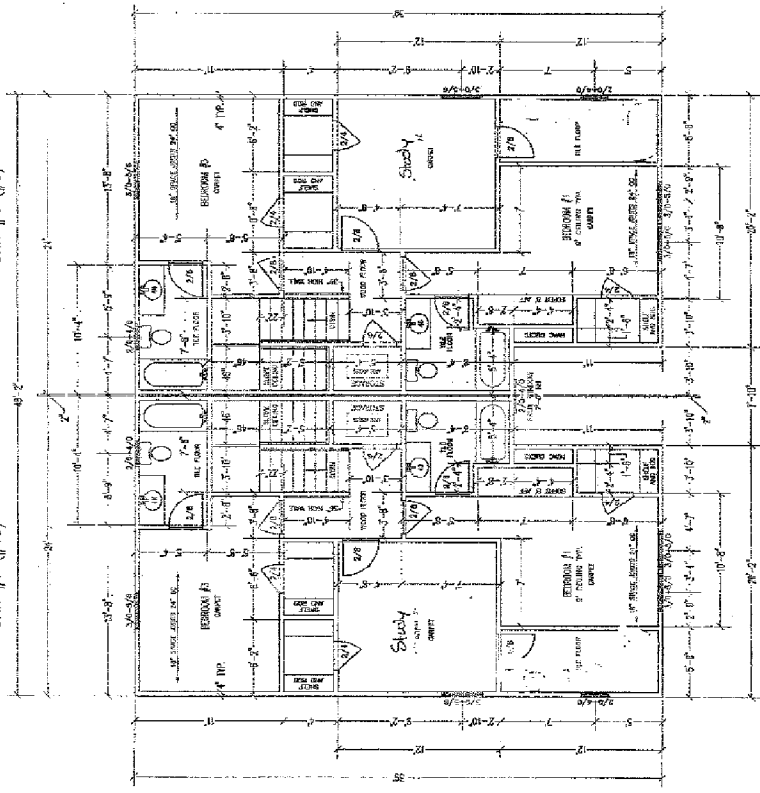

NO.	REVISION	DATE	BY	CHKD.
1	ISSUED FOR PERMITS	02/14/10	JL	ML
2	REVISED PER COMMENTS	02/14/10	JL	ML
3	REVISED PER COMMENTS	02/14/10	JL	ML
4	REVISED PER COMMENTS	02/14/10	JL	ML
5	REVISED PER COMMENTS	02/14/10	JL	ML
6	REVISED PER COMMENTS	02/14/10	JL	ML
7	REVISED PER COMMENTS	02/14/10	JL	ML
8	REVISED PER COMMENTS	02/14/10	JL	ML
9	REVISED PER COMMENTS	02/14/10	JL	ML
10	REVISED PER COMMENTS	02/14/10	JL	ML
11	REVISED PER COMMENTS	02/14/10	JL	ML
12	REVISED PER COMMENTS	02/14/10	JL	ML
13	REVISED PER COMMENTS	02/14/10	JL	ML
14	REVISED PER COMMENTS	02/14/10	JL	ML
15	REVISED PER COMMENTS	02/14/10	JL	ML
16	REVISED PER COMMENTS	02/14/10	JL	ML
17	REVISED PER COMMENTS	02/14/10	JL	ML
18	REVISED PER COMMENTS	02/14/10	JL	ML
19	REVISED PER COMMENTS	02/14/10	JL	ML
20	REVISED PER COMMENTS	02/14/10	JL	ML
21	REVISED PER COMMENTS	02/14/10	JL	ML
22	REVISED PER COMMENTS	02/14/10	JL	ML
23	REVISED PER COMMENTS	02/14/10	JL	ML
24	REVISED PER COMMENTS	02/14/10	JL	ML
25	REVISED PER COMMENTS	02/14/10	JL	ML
26	REVISED PER COMMENTS	02/14/10	JL	ML
27	REVISED PER COMMENTS	02/14/10	JL	ML
28	REVISED PER COMMENTS	02/14/10	JL	ML
29	REVISED PER COMMENTS	02/14/10	JL	ML
30	REVISED PER COMMENTS	02/14/10	JL	ML
31	REVISED PER COMMENTS	02/14/10	JL	ML
32	REVISED PER COMMENTS	02/14/10	JL	ML
33	REVISED PER COMMENTS	02/14/10	JL	ML
34	REVISED PER COMMENTS	02/14/10	JL	ML
35	REVISED PER COMMENTS	02/14/10	JL	ML
36	REVISED PER COMMENTS	02/14/10	JL	ML
37	REVISED PER COMMENTS	02/14/10	JL	ML
38	REVISED PER COMMENTS	02/14/10	JL	ML
39	REVISED PER COMMENTS	02/14/10	JL	ML
40	REVISED PER COMMENTS	02/14/10	JL	ML
41	REVISED PER COMMENTS	02/14/10	JL	ML
42	REVISED PER COMMENTS	02/14/10	JL	ML
43	REVISED PER COMMENTS	02/14/10	JL	ML
44	REVISED PER COMMENTS	02/14/10	JL	ML
45	REVISED PER COMMENTS	02/14/10	JL	ML
46	REVISED PER COMMENTS	02/14/10	JL	ML
47	REVISED PER COMMENTS	02/14/10	JL	ML
48	REVISED PER COMMENTS	02/14/10	JL	ML
49	REVISED PER COMMENTS	02/14/10	JL	ML
50	REVISED PER COMMENTS	02/14/10	JL	ML

THESE LINE WORK SPACES ARE TO BE MAINTAINED AS SUCH AND SHOULD NOT BE USED FOR ANY OTHER PURPOSES. THESE SPACES ARE TO BE MAINTAINED AS SUCH AND SHOULD NOT BE USED FOR ANY OTHER PURPOSES.

RESUBMITTED
RECEIVED
FEB 23 2010
City of Chicago
Building Department

Oasis Designs FLOOR PLAN
3992 Amstel Street Rd
Tulhanna, IL 62350
(815) 668-3111
oasisdesigns.com
SCALE: 1/8" = 1'-0"
SHEET #6 OF 8
DATE: 02/22/10
DWG: OASIS_3RD02_H & J7
(01_3RD02_H & J7)

SEE NOTE
DO NOT USE THE LINE WORK SPACES FOR ANY OTHER PURPOSES.

SEE NOTE
DO NOT USE THE LINE WORK SPACES FOR ANY OTHER PURPOSES.

SEE NOTE
DO NOT USE THE LINE WORK SPACES FOR ANY OTHER PURPOSES.

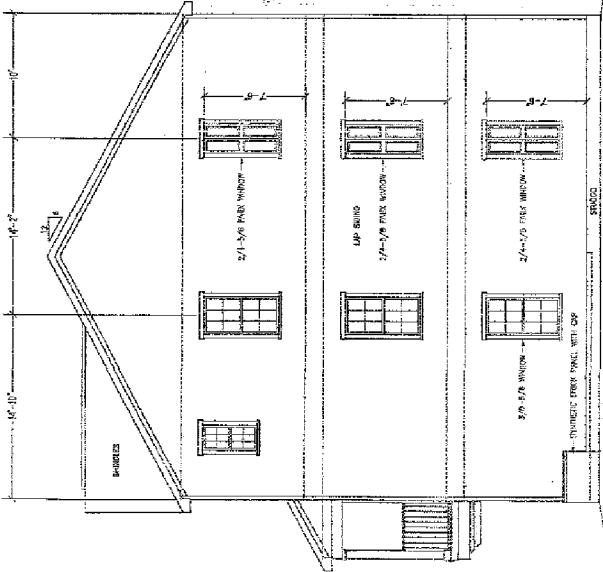

SIDE ELEVATION

DATE: 10/22/12
 DRAWN BY: [Name]
 CHECKED BY: [Name]

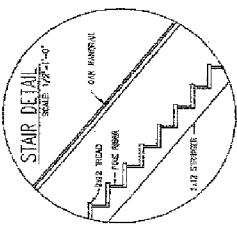

STAIR DETAIL
 SCALE: 1/2\"/>

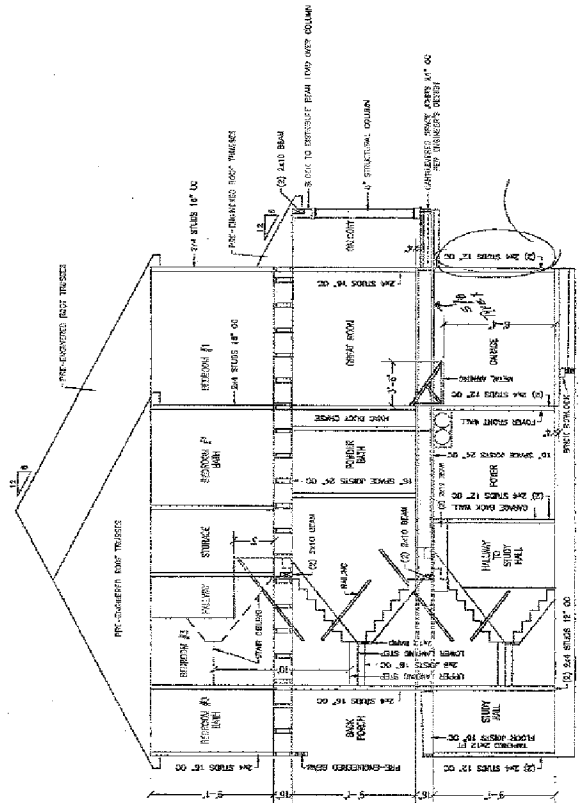

CROSS SECTION

ALL DIMENSIONS ARE TO FACE UNLESS NOTED OTHERWISE.
 FINISHES ARE TO BE AS SHOWN IN THE FINISH SCHEDULE.
 MATERIALS AND METHODS OF CONSTRUCTION ARE TO BE AS SHOWN IN THE SPECIFICATIONS.
 THE CONTRACTOR SHALL BE RESPONSIBLE FOR OBTAINING ALL NECESSARY PERMITS AND APPROVALS FROM THE LOCAL AUTHORITIES.
 THE CONTRACTOR SHALL BE RESPONSIBLE FOR OBTAINING ALL NECESSARY PERMITS AND APPROVALS FROM THE LOCAL AUTHORITIES.

ROOF PITCH: 12/12
 ROOF TRUSSES: 2x4
 ROOF SHEATHING: 1/2\"/>

Oasis Designs	SECTIONS	
	SCALE: 1/2" = 1'-0"	SHEET: 16 OF 16
4992 Ansel Henriel Rd. Tallahassee, FL 32309 (904) 658-5111 OasisDesigns.com	DATE: 10/22/12	NAME: CHRIS BLOTT (OR: 0415 21 4 17)

1775

BELLE VUE WAY
(60' PAVED PUBLIC RIGHT OF WAY)

EXHIBIT Q

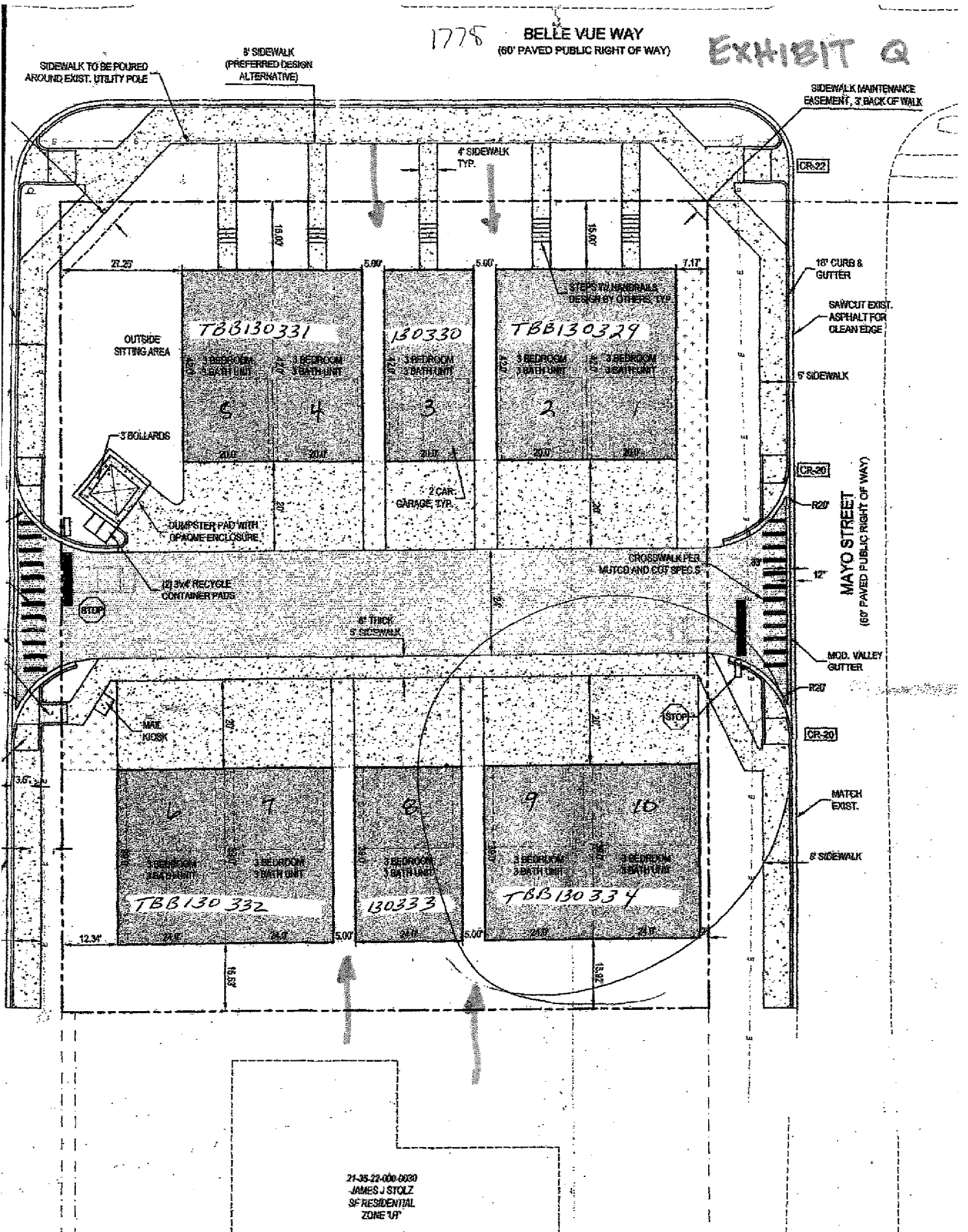

21-35-22-000-0030
JAMES J STOLZ
9F RESIDENTIAL
ZONE 'UP'

Q. TWENTY

Q

Q

Q

EXHIBIT R

R

10/10

UNIT #7 (#10) INTER. FLOOR LEVEL UNIT #6 (#9)

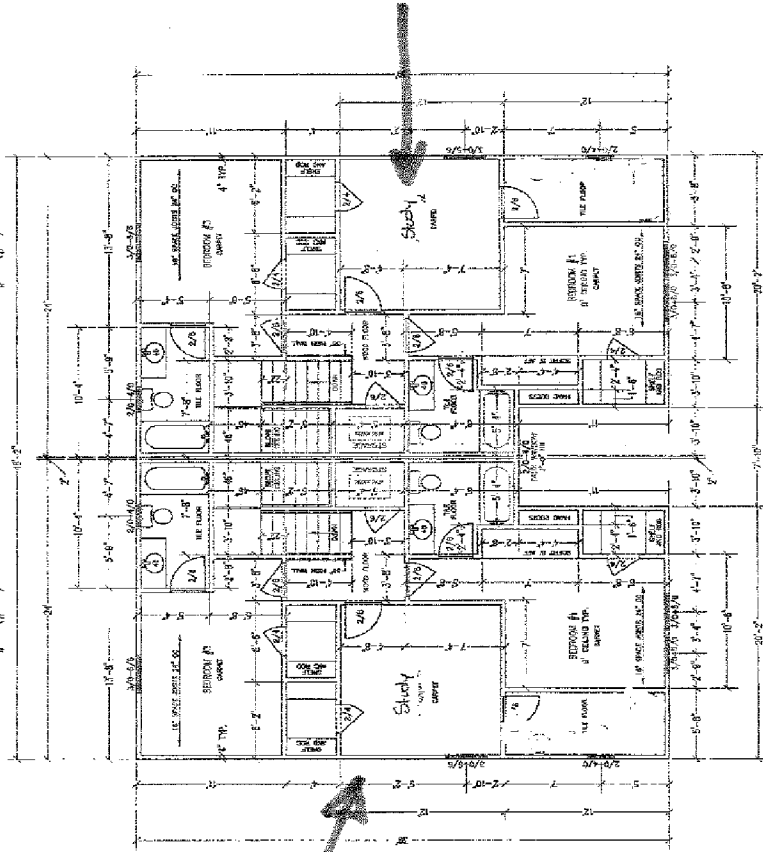

NO.	DESCRIPTION	QTY	UNIT	PRICE	TOTAL
1	CONCRETE	100	YD	120.00	12000.00
2	STEEL	50	LB	0.50	25.00
3	WOOD	200	BF	1.00	200.00
4	PAINT	100	GA	1.50	150.00
5	GLASS	50	PF	2.00	100.00
6	CEILING	100	SQ	0.80	80.00
7	FLOORING	100	SQ	1.00	100.00
8	MECHANICAL	100	HR	1.00	100.00
9	ELECTRICAL	100	HR	1.00	100.00
10	PLUMBING	100	HR	1.00	100.00
11	LANDSCAPE	100	SQ	1.00	100.00
12	CONCRETE	100	YD	120.00	12000.00
13	STEEL	50	LB	0.50	25.00
14	WOOD	200	BF	1.00	200.00
15	PAINT	100	GA	1.50	150.00
16	GLASS	50	PF	2.00	100.00
17	CEILING	100	SQ	0.80	80.00
18	FLOORING	100	SQ	1.00	100.00
19	MECHANICAL	100	HR	1.00	100.00
20	ELECTRICAL	100	HR	1.00	100.00
21	PLUMBING	100	HR	1.00	100.00
22	LANDSCAPE	100	SQ	1.00	100.00
23	CONCRETE	100	YD	120.00	12000.00
24	STEEL	50	LB	0.50	25.00
25	WOOD	200	BF	1.00	200.00
26	PAINT	100	GA	1.50	150.00
27	GLASS	50	PF	2.00	100.00
28	CEILING	100	SQ	0.80	80.00
29	FLOORING	100	SQ	1.00	100.00
30	MECHANICAL	100	HR	1.00	100.00
31	ELECTRICAL	100	HR	1.00	100.00
32	PLUMBING	100	HR	1.00	100.00
33	LANDSCAPE	100	SQ	1.00	100.00
34	CONCRETE	100	YD	120.00	12000.00
35	STEEL	50	LB	0.50	25.00
36	WOOD	200	BF	1.00	200.00
37	PAINT	100	GA	1.50	150.00
38	GLASS	50	PF	2.00	100.00
39	CEILING	100	SQ	0.80	80.00
40	FLOORING	100	SQ	1.00	100.00
41	MECHANICAL	100	HR	1.00	100.00
42	ELECTRICAL	100	HR	1.00	100.00
43	PLUMBING	100	HR	1.00	100.00
44	LANDSCAPE	100	SQ	1.00	100.00
45	CONCRETE	100	YD	120.00	12000.00
46	STEEL	50	LB	0.50	25.00
47	WOOD	200	BF	1.00	200.00
48	PAINT	100	GA	1.50	150.00
49	GLASS	50	PF	2.00	100.00
50	CEILING	100	SQ	0.80	80.00
51	FLOORING	100	SQ	1.00	100.00
52	MECHANICAL	100	HR	1.00	100.00
53	ELECTRICAL	100	HR	1.00	100.00
54	PLUMBING	100	HR	1.00	100.00
55	LANDSCAPE	100	SQ	1.00	100.00
56	CONCRETE	100	YD	120.00	12000.00
57	STEEL	50	LB	0.50	25.00
58	WOOD	200	BF	1.00	200.00
59	PAINT	100	GA	1.50	150.00
60	GLASS	50	PF	2.00	100.00
61	CEILING	100	SQ	0.80	80.00
62	FLOORING	100	SQ	1.00	100.00
63	MECHANICAL	100	HR	1.00	100.00
64	ELECTRICAL	100	HR	1.00	100.00
65	PLUMBING	100	HR	1.00	100.00
66	LANDSCAPE	100	SQ	1.00	100.00
67	CONCRETE	100	YD	120.00	12000.00
68	STEEL	50	LB	0.50	25.00
69	WOOD	200	BF	1.00	200.00
70	PAINT	100	GA	1.50	150.00
71	GLASS	50	PF	2.00	100.00
72	CEILING	100	SQ	0.80	80.00
73	FLOORING	100	SQ	1.00	100.00
74	MECHANICAL	100	HR	1.00	100.00
75	ELECTRICAL	100	HR	1.00	100.00
76	PLUMBING	100	HR	1.00	100.00
77	LANDSCAPE	100	SQ	1.00	100.00
78	CONCRETE	100	YD	120.00	12000.00
79	STEEL	50	LB	0.50	25.00
80	WOOD	200	BF	1.00	200.00
81	PAINT	100	GA	1.50	150.00
82	GLASS	50	PF	2.00	100.00
83	CEILING	100	SQ	0.80	80.00
84	FLOORING	100	SQ	1.00	100.00
85	MECHANICAL	100	HR	1.00	100.00
86	ELECTRICAL	100	HR	1.00	100.00
87	PLUMBING	100	HR	1.00	100.00
88	LANDSCAPE	100	SQ	1.00	100.00
89	CONCRETE	100	YD	120.00	12000.00
90	STEEL	50	LB	0.50	25.00
91	WOOD	200	BF	1.00	200.00
92	PAINT	100	GA	1.50	150.00
93	GLASS	50	PF	2.00	100.00
94	CEILING	100	SQ	0.80	80.00
95	FLOORING	100	SQ	1.00	100.00
96	MECHANICAL	100	HR	1.00	100.00
97	ELECTRICAL	100	HR	1.00	100.00
98	PLUMBING	100	HR	1.00	100.00
99	LANDSCAPE	100	SQ	1.00	100.00
100	CONCRETE	100	YD	120.00	12000.00

GENERAL NOTES:
 1. REFER TO ALL OTHER SHEETS FOR NOTES.
 2. ALL WORK SHALL BE IN ACCORDANCE WITH THE LATEST EDITIONS OF THE BUILDING CODES AND ALL APPLICABLE REGULATIONS.
 3. ALL MATERIALS SHALL BE OF THE BEST QUALITY AVAILABLE AND SHALL BE SUBJECT TO INSPECTION AND APPROVAL BY THE ARCHITECT.
 4. THE CONTRACTOR SHALL BE RESPONSIBLE FOR OBTAINING ALL NECESSARY PERMITS AND APPROVALS.
 5. THE CONTRACTOR SHALL MAINTAIN ACCESS TO ALL ADJACENT PROPERTIES AT ALL TIMES.
 6. ALL UTILITIES SHALL BE PROTECTED AND DEEPLY REPAIRED.
 7. THE CONTRACTOR SHALL BE RESPONSIBLE FOR THE PROTECTION AND REPAIR OF ALL EXISTING UTILITIES.
 8. ALL WORK SHALL BE COMPLETED WITHIN THE SPECIFIED TIME FRAME.
 9. THE CONTRACTOR SHALL MAINTAIN A NEAT AND SAFE WORKING ENVIRONMENT.
 10. ALL MATERIALS SHALL BE STORED PROPERLY AND PROTECTED FROM THE ELEMENTS.

ASSISTANT
 RECEIVED
 CITY OF TALLAHASSEE
 115 2ND ST
 TALLAHASSEE, FL 32309

Oasis Designs
 5900 Avenue Road
 Tallahassee, FL 32309
 (904) 608-3111
 OasisDesigns.com

FLOOR PLAN
 SCALE: 1/4" = 1'-0"
 SHEET # 6 OF 6
 DATE: 12/22/16
 DWG: OASIS UNIT #6 & #7
 (REVISED # 2 & 10)

NOTES:
 1. REFER TO ALL OTHER SHEETS FOR NOTES.
 2. ALL WORK SHALL BE IN ACCORDANCE WITH THE LATEST EDITIONS OF THE BUILDING CODES AND ALL APPLICABLE REGULATIONS.
 3. ALL MATERIALS SHALL BE OF THE BEST QUALITY AVAILABLE AND SHALL BE SUBJECT TO INSPECTION AND APPROVAL BY THE ARCHITECT.
 4. THE CONTRACTOR SHALL BE RESPONSIBLE FOR OBTAINING ALL NECESSARY PERMITS AND APPROVALS.
 5. THE CONTRACTOR SHALL MAINTAIN ACCESS TO ALL ADJACENT PROPERTIES AT ALL TIMES.
 6. ALL UTILITIES SHALL BE PROTECTED AND DEEPLY REPAIRED.
 7. THE CONTRACTOR SHALL BE RESPONSIBLE FOR THE PROTECTION AND REPAIR OF ALL EXISTING UTILITIES.
 8. ALL WORK SHALL BE COMPLETED WITHIN THE SPECIFIED TIME FRAME.
 9. THE CONTRACTOR SHALL MAINTAIN A NEAT AND SAFE WORKING ENVIRONMENT.
 10. ALL MATERIALS SHALL BE STORED PROPERLY AND PROTECTED FROM THE ELEMENTS.

NOTES:
 1. REFER TO ALL OTHER SHEETS FOR NOTES.
 2. ALL WORK SHALL BE IN ACCORDANCE WITH THE LATEST EDITIONS OF THE BUILDING CODES AND ALL APPLICABLE REGULATIONS.
 3. ALL MATERIALS SHALL BE OF THE BEST QUALITY AVAILABLE AND SHALL BE SUBJECT TO INSPECTION AND APPROVAL BY THE ARCHITECT.
 4. THE CONTRACTOR SHALL BE RESPONSIBLE FOR OBTAINING ALL NECESSARY PERMITS AND APPROVALS.
 5. THE CONTRACTOR SHALL MAINTAIN ACCESS TO ALL ADJACENT PROPERTIES AT ALL TIMES.
 6. ALL UTILITIES SHALL BE PROTECTED AND DEEPLY REPAIRED.
 7. THE CONTRACTOR SHALL BE RESPONSIBLE FOR THE PROTECTION AND REPAIR OF ALL EXISTING UTILITIES.
 8. ALL WORK SHALL BE COMPLETED WITHIN THE SPECIFIED TIME FRAME.
 9. THE CONTRACTOR SHALL MAINTAIN A NEAT AND SAFE WORKING ENVIRONMENT.
 10. ALL MATERIALS SHALL BE STORED PROPERLY AND PROTECTED FROM THE ELEMENTS.

NOTES:
 1. REFER TO ALL OTHER SHEETS FOR NOTES.
 2. ALL WORK SHALL BE IN ACCORDANCE WITH THE LATEST EDITIONS OF THE BUILDING CODES AND ALL APPLICABLE REGULATIONS.
 3. ALL MATERIALS SHALL BE OF THE BEST QUALITY AVAILABLE AND SHALL BE SUBJECT TO INSPECTION AND APPROVAL BY THE ARCHITECT.
 4. THE CONTRACTOR SHALL BE RESPONSIBLE FOR OBTAINING ALL NECESSARY PERMITS AND APPROVALS.
 5. THE CONTRACTOR SHALL MAINTAIN ACCESS TO ALL ADJACENT PROPERTIES AT ALL TIMES.
 6. ALL UTILITIES SHALL BE PROTECTED AND DEEPLY REPAIRED.
 7. THE CONTRACTOR SHALL BE RESPONSIBLE FOR THE PROTECTION AND REPAIR OF ALL EXISTING UTILITIES.
 8. ALL WORK SHALL BE COMPLETED WITHIN THE SPECIFIED TIME FRAME.
 9. THE CONTRACTOR SHALL MAINTAIN A NEAT AND SAFE WORKING ENVIRONMENT.
 10. ALL MATERIALS SHALL BE STORED PROPERLY AND PROTECTED FROM THE ELEMENTS.

ALL WORK SHALL BE IN ACCORDANCE WITH THE LATEST EDITIONS OF THE BUILDING CODES AND ALL APPLICABLE REGULATIONS.

2. 10/10/10

2

10/10/10

10/10/10

DEVELOPMENT REVIEW COMMITTEE AGENDA

April 8, 2013

9:00 a.m.

435 North Macomb Street
Growth Management Conference Room
First Floor/Renaissance Center

AGENDA MODIFICATIONS:

OLD BUSINESS:

NONE

NEW BUSINESS:

PLANNED UNIT DEVELOPMENT

1. **Welaunee Toe-East Planned Unit Development (PRZ130002)** – The proposed project is a Concept Plan application for a PUD on approximately 430 acres located southeast of Centerville Road, south of Interstate 10, north and west of the Miccosukee Canopy Road Greenway, and east of Dove Pond and Canopy PUD. The proposed PUD includes up to 1,817 dwelling units of varying types and 272,441 gross square feet of non-residential land uses which are configured in Town and Neighborhood Center(s) and residential areas.

Approval _____ Denial _____ Continued to _____

PROJECT COORDINATOR: Mary Jean Yarbrough -Planning Dept. (891-6400)
Tax ID #: 11-14-20-802-0000 and 11-14-20-403-0000
Agent: Wood + Partners, Inc. - 391-0360

NEW BUSINESS:

TYPE B SITE PLAN

2. **Campus Block Apartments Major Modification (TSP130009)** located on 0.59-acre at 300 and 304 Mayo Street. The proposed modification to the previously approved site plan (TSP120026) is to construct 10 multi-family, 4-bedroom dwelling units. The applicant is requesting two deviations to the development standards in order to eliminate the step back requirement and to increase the side corner setback from a maximum of 15 feet to 27.25 feet. The site is zoned UT (University Transition).

Approval _____ Denial _____ Continued to _____

PROJECT COORDINATOR: Cindy Smith-South Team (891-7100)
Tax ID #: 21-35-22-000-0010 and 21-35-22-000-0020
Agent: Moore Bass Consulting – 222-5678

NEW BUSINESS:

TYPE B SITE PLAN

- 3. The Woodlands of Tallahassee (TSP130010)** located on 20.5 acres on the southeast corner of West Tennessee Street and Valencia Drive. The proposed project is the construction of a 291-unit multi-family apartment complex. The applicant is requesting a deviation to the development standards in order to eliminate the step back requirement. The site is zoned UT (University Transition) and CP (Commercial Parkway).

Approval _____ Denial _____ Continued to _____

PROJECT COORDINATOR: Sheila Williams-South Team (891-7100)
Tax I.D. # Several on file with the Growth Management Department
Agent: Moore Bass Consulting – 222-5678

NEW BUSINESS:

TYPE C SITE PLAN

- 4. Symphony Seven School of Arts & Technology Type C Site Plan (PSP130001)** – The application is a site plan approval to allow the addition of a private school (K-5) to a religious facility. The total site area is 2.42 acres and is located at the southwest corner of Indian Head Drive East and Chowkeebin Nene.

Approval _____ Denial _____ Continued to _____

PROJECT COORDINATOR: Mary Jean Yarbrough –Planning Dept. (891-6400)
Tax I.D. # 31-05-20-216-0000
Agent: Dr. Marcella Torres – 878-1752

"Please be advised that if a person decides to appeal any decision made by the Development Review Committee with respect to any matter considered at this meeting, such person will need a record of these proceedings, and for this purpose such person may need to ensure that a verbatim record of the proceedings is made, which record includes the testimony and evidence upon which the appeal is to be based."

EXHIBIT T



Most Livable City in America

April 8, 2013

Mr. Edward N. Bass, III, P.E.
Moore Bass Consulting, Inc.
805 N. Gadsden St.
Tallahassee, FL 32303

Re: Campus Block
Type B Site Plan Conditional Approval (TSP130009)
Parcel Tax ID No. 21-35-22-000-0010 and 21-35-22-000-0020

Dear Mr. Bass:

The Campus Block Type B Site Plan was **conditionally** approved on April 8, 2013 by the City of Tallahassee Development Review Committee, subject to the following conditions.

GROWTH MANAGEMENT DEPARTMENT:

LAND USE CONDITIONS:

1. Remove the four parking spaces that are located in the second layer. Place a note on the site plan that parking is not allowed in these areas.

WATER UTILITIES:

1. An approved service plan will be required as a condition of approval. Water and sewer demands must also be submitted.
2. Water and sewer demand calculations must be submitted by the engineer of record and be signed and sealed.
3. As typical, the developer must supply needed fire flow calculations and have approval from the Fire Department that the proposed fire protection will be adequate for the development.

In order for the project to proceed with environmental and building permitting, these **conditions of approval** must be addressed prior to the release of the site plan for permitting. Please submit revised plans reflecting the above-referenced conditions. Section 9-154(9)e of the *Tallahassee Land Development Code (TLDC)* specifies that revisions resulting from this **conditional approval** shall be resubmitted within ninety (90) days of the Type A meeting date. Revised plans will be reviewed for acceptance within ten (10) working days of receipt, and if acceptable will be signed by the Director of Growth Management (or designee) before the site plan can be accepted as the approved site plan. Please be advised that the revised plans should only reflect the changes that are necessary to satisfy the above-referenced conditions, and should otherwise

CITY HALL
500 South Adams Street
Tallahassee, FL 32301-1731
850-891-0000
TDD: 711 • Talgov.com

JOHN R. MARKS, III
Mayor

ANITA E. THOMPSON
City Manager

ANDREW GILLUM
Commissioner

LEWIS E. SHELLEY
City Attorney

SCOTT MADDUX
Commissioner

JAMES O. COOKE, IV
City Treasurer-Clerk

NANCY MILLER
Commissioner

SAM M. McCALL
City Auditor

GIL D. ZIFFER
Commissioner

T 7/18/14/KJ
T

Campus Block (TSP130009)

April 8, 2013

Page 2

be identical to the plans originally submitted for review. This **conditional approval** is based on the following findings:

1. Land Use Compliance Certificate (LUCC) Number TCC120050 certifies the zoning on the subject site as UT (University Transition), MMTD, Transect 5, and the site is eligible for development with 10, 4-bedroom multi-family units at a density of 16.95 units per acre.
2. The Type B Site Plan is consistent with LUCC Number TCC120050. This Development Order grants conditional approval for 10, 4-bedroom multi-family units.
3. A site plan release, contingent upon satisfaction of the **conditions of approval**, an Environmental Management Permit and a Building Permit will be required in order to proceed with development.
4. Based on the above findings, it has been determined that the site plan is consistent with the *TLDC*. Should no revised plans be submitted within ninety (90) days from today's date or an extension granted by the Land Use Administrator, this approval shall be deemed null and void. Once it's been determined that the revised plans comply with the **conditions of approval** and a site plan release has been issued by the Department, this site plan shall expire should no permits be secured nor any development activity be commenced by 12 PM on April 8, 2016.

Please note this decision shall become final thirty (30) calendar days after it is rendered unless a person who qualifies as a party under Section 2-134 of the *TLDC* files a petition for formal proceedings pursuant to Section 2-135 of the *TLDC* before the Tallahassee-Leon County Planning Commission, pays the appropriate filing fee, and completes the application by filing a petition for formal proceedings within thirty (30) calendar days after the decision is rendered. Petition forms may be obtained from the Tallahassee-Leon County Planning Department (891-6400). The determination of who qualifies as a party is made by the Planning Commission after a petition is filed. The petition must be filed with the Tallahassee-Leon County Planning Department and the Planning Commission Attorney on the same day. Notices to the Tallahassee-Leon County Planning Department should be delivered to 435 North Macomb Street, Tallahassee, Florida 32301. Notices to the Planning Commission Attorney should be delivered to Chris H. Bentley, P.A., at Rose, Sundstrom & Bentley, LLP, 2548 Blairstone Pines Drive, Tallahassee, FL 32301. The petition for formal proceedings must be filed within thirty (30) calendar days after the decision sought to be appealed is rendered. Failure to file the petition within the time specified herein will result in waiver of the right to formal proceedings. The Planning Commission Clerk will dismiss any late filed petition.

If the property owner feels that this order is unreasonable or unfairly burdens the use of his/her land, he/she may apply to the City of Tallahassee within 30 days of the receipt of this order for relief under Sec. 70.51, Florida Statutes, the Florida Land Use and Environmental Dispute Resolution Act. The request for relief should be filed with the City Attorney, 300 S. Adams St.,

7

Campus Block (TSP130009)

April 8, 2013

Page 3

Tallahassee, FL, pursuant to City Commission Policy 414CP, which is available on line at Talgov.com under the Treasurer-Clerk's web site or by calling the City Attorney's Office at (850) 891-8554.

Should you need additional information or clarification, please call me at 891-7076.

Sincerely,

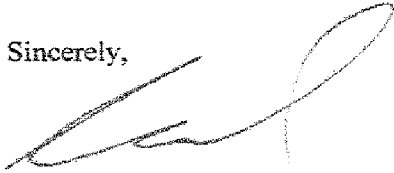

Keith Burnsed, AICP
Development Review Committee, Chair

T 1000000

T

FIRST FLOOR LEVEL

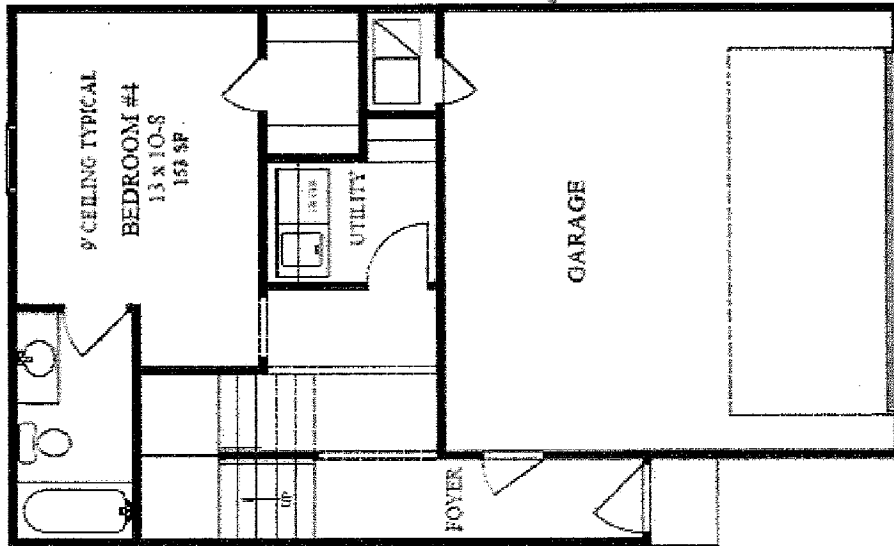

SECOND FLOOR LEVEL

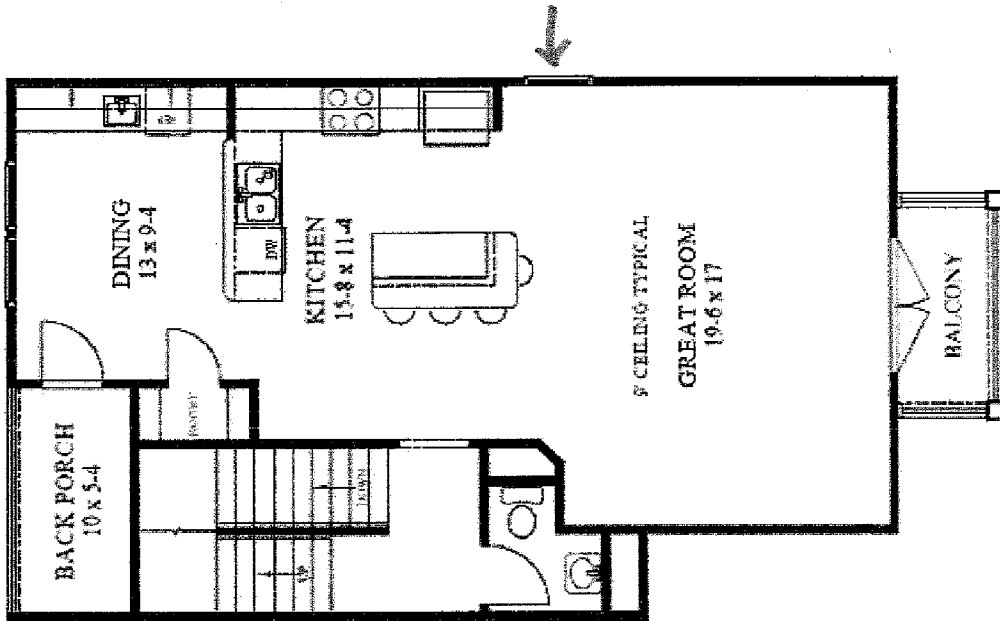

THIRD FLOOR LEVEL

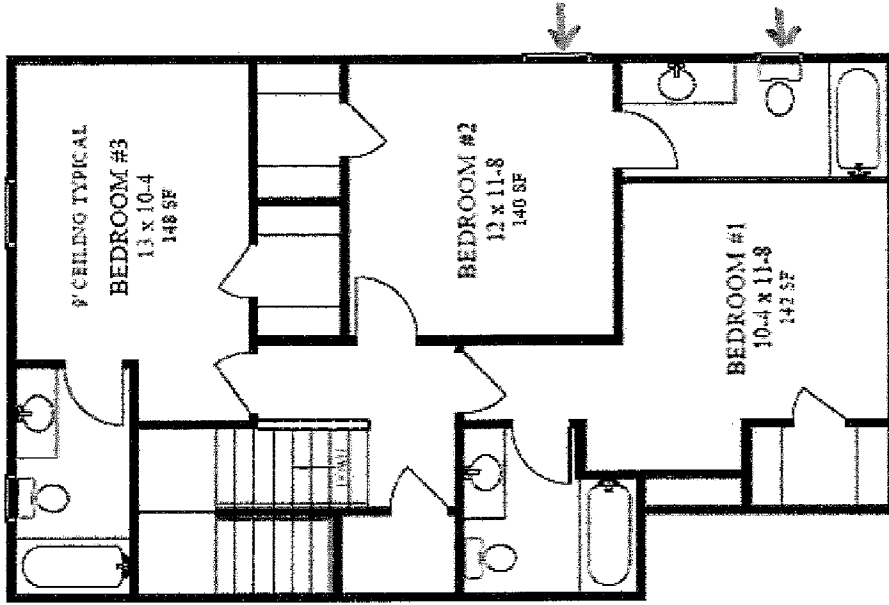

496 SF	FIRST FLOOR LEVEL
841 SF	SECOND FLOOR LEVEL
824 SF	THIRD FLOOR LEVEL
2161 SF	TOTAL CONDITIONED SPACE
400 SF	GARAGE
56 SF	BACK PORCH
47 SF	BALCONY
12 SF	FRONT PORCH

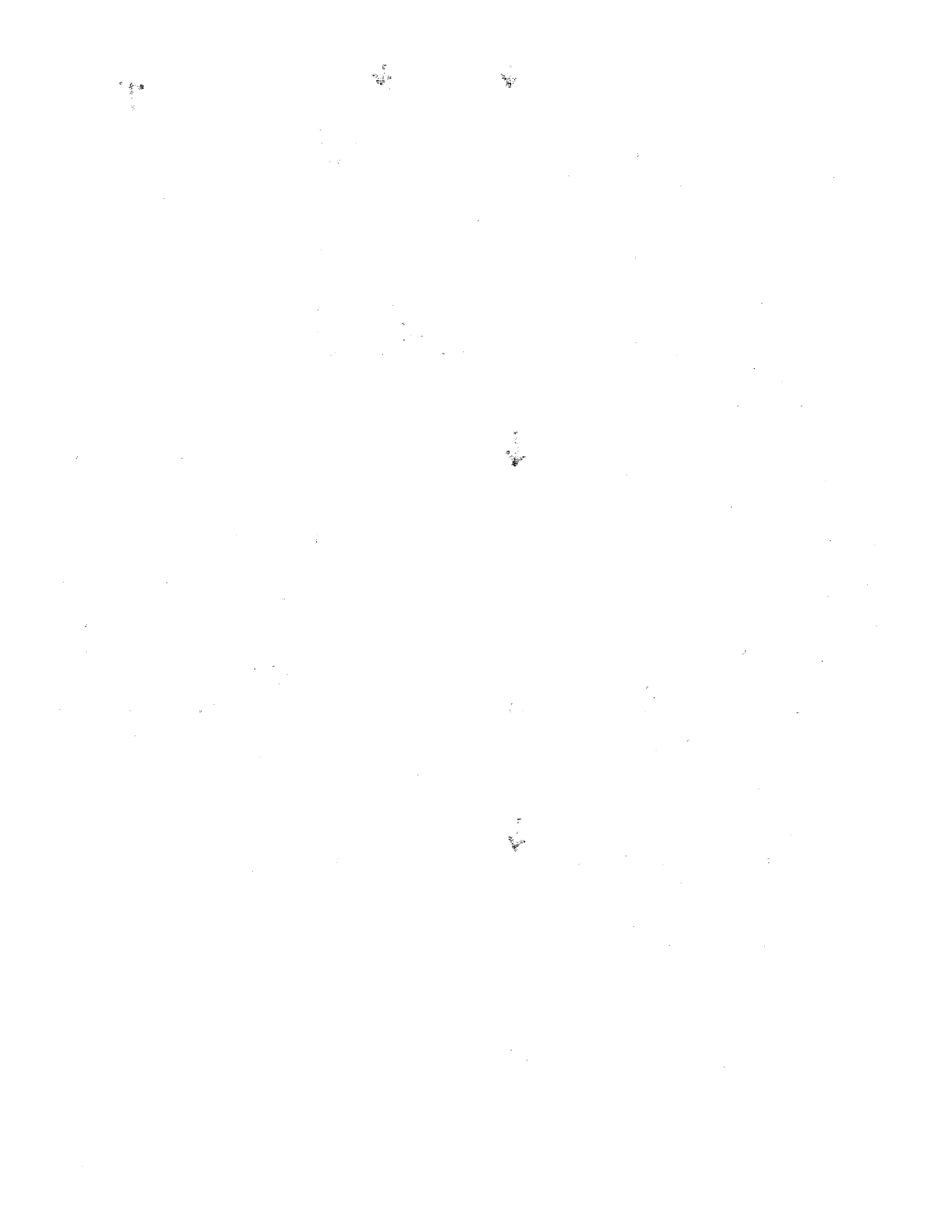

MAJOR MODIFICATION TO APPROVED TYPE 'B' SITE PLAN (TSP 120026)

APPROVED
CITY OF
TALLAHASSEE
FLORIDA

Plan Officially Approved For:
TSP 120026

Approved By:
[Signature]

Stamp of:
[Signature]

Approval Date: 04/07/2013

Revision On: 01/20/16

FOR

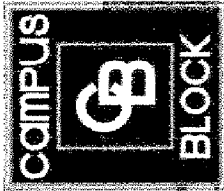

SHEET	DESCRIPTION
1.0	COVER SHEET
2.0	EXISTING CONDITIONS MAP
3.0	GEOMETRY PLAN
4.0	GRADING PLAN
5.0	OFF-SITE DRAINAGE PLAN
6.0	CONCEPT UTILITY PLAN
7.0	TURNING MOVEMENT PLAN

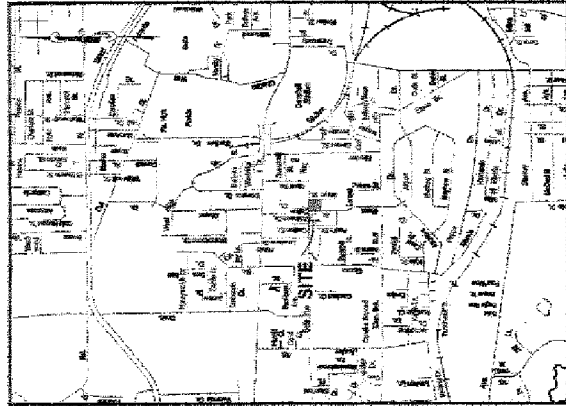

VICINITY MAP
SCALE: 1" = 100'

INDEX

TAX ID. NO.:	21-35-22-000-0010, 21-35-22-000-0020
PROJECT NAME:	CAMPUS BLOCK
CLIENT NAME:	CAMPUS BLOCK FSU, LLC 2460 FOREST CLUB DRIVE ORLANDO, FLORIDA 32804 (407)923-6366
PREPARED BY:	MOORE BASS CONSULTING, INC. 805 NORTH GADSDEN STREET TALLAHASSEE, FLORIDA 32303 (850)222-5878
ENGINEER OF RECORD:	EDWARD N. BASS, III, P.E. FL. REG. NO. 62949 805 NORTH GADSDEN STREET TALLAHASSEE, FLORIDA 32303 (850)222-5878
SURVEYOR OF RECORD:	LARRY D. DAVIS REG. FL. SURVEYOR No. 6264 805 NORTH GADSDEN STREET TALLAHASSEE, FLORIDA 32303 (850)222-5878

PROJECT DATA

Elevations are based on N.A.S.D. 88 Datum.
GOVERNING SPECIFICATIONS:
F.D.O.T. Specifications for Road and Bridge Construction, 2010
F.D.O.T. Design Standards, 2010
F.D.O.T. Manual of Uniform Minimum Standards for Design, Construction and Maintenance for Streets and Highways
(Green Book)
City of Tallahassee Standard Specifications for the Design and Construction of Water and Wastewater Facilities, Jan. 26 2010

PROPOSED UTILITY PROVISIONS FOR THIS PROJECT:
NONE. SEE UTILITY PLAN SHEET.
REVISIONS: 01/20/16
JOB NUMBER: 120026

PRELIMINARY
NOT FOR CONSTRUCTION

1.0

Moore Bass
CAMPUS BLOCK
PROJECT NAME
CAMPUS BLOCK FSU, LLC
2460 FOREST CLUB DRIVE
ORLANDO, FLORIDA 32804
MOORE BASS CONSULTING, INC.
805 NORTH GADSDEN STREET
TALLAHASSEE, FLORIDA 32303
EDWARD N. BASS, III, P.E.
FL. REG. NO. 62949
LARRY D. DAVIS
REG. FL. SURVEYOR No. 6264
MB
SCALE: 1" = 100'

MOORE Bass
CONSULTING

PROJECT: GARDENS BLOCK
CLIENT: GARDENS BLOCK, FOR, LLC
DEVELOPER: GARDENS BLOCK, FOR, LLC
DATE: 08/20/2014

PROJECT NO.	DATE
PROJECT NAME	DATE
PROJECT ADDRESS	DATE
PROJECT CITY	DATE
PROJECT STATE	DATE
PROJECT ZIP	DATE



THIS MAP IS A PRELIMINARY PLANNING MAP AND IS NOT TO BE USED FOR ANY OTHER PURPOSE. IT IS THE PROPERTY OF MOORE CONSULTING AND IS NOT TO BE REPRODUCED OR TRANSMITTED IN ANY FORM OR BY ANY MEANS, ELECTRONIC OR MECHANICAL, INCLUDING PHOTOCOPYING, RECORDING, OR BY ANY INFORMATION STORAGE AND RETRIEVAL SYSTEM, WITHOUT THE WRITTEN PERMISSION OF MOORE CONSULTING.

2.0

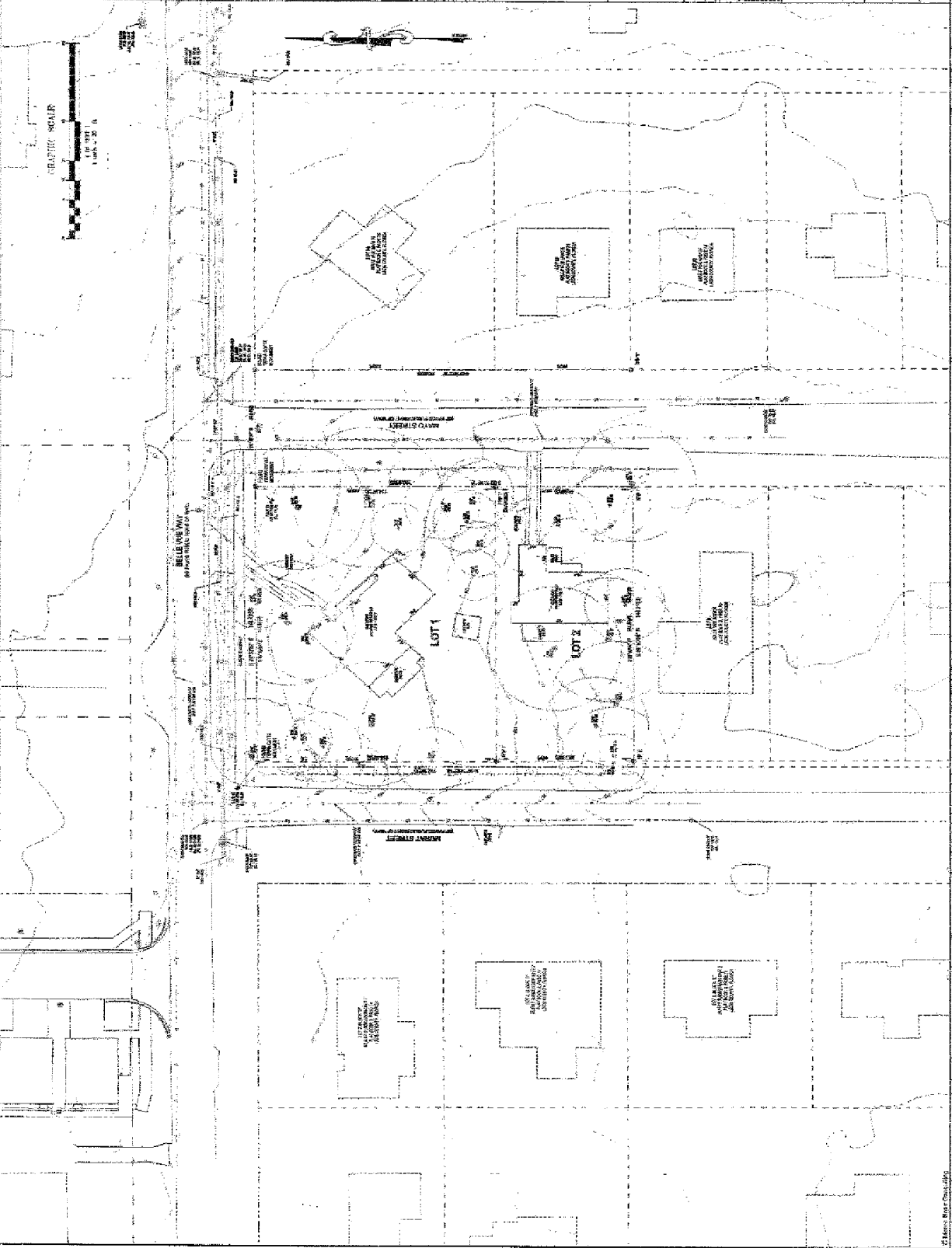

		PROJECT NAME CARROLL BLOCK	CLIENT NAME CARROLL BLOCK AND L.L.B.	DATE 11/11/11	SCALE 1" = 100'	SHEET TITLE CARROLL BLOCK	5.0
	PROJECT NUMBER 11111	CLIENT ADDRESS 11111	PROJECT LOCATION 11111	PROJECT DESCRIPTION 11111	PROJECT STATUS 11111	PROJECT OWNER 11111	PROJECT CONTACT 11111

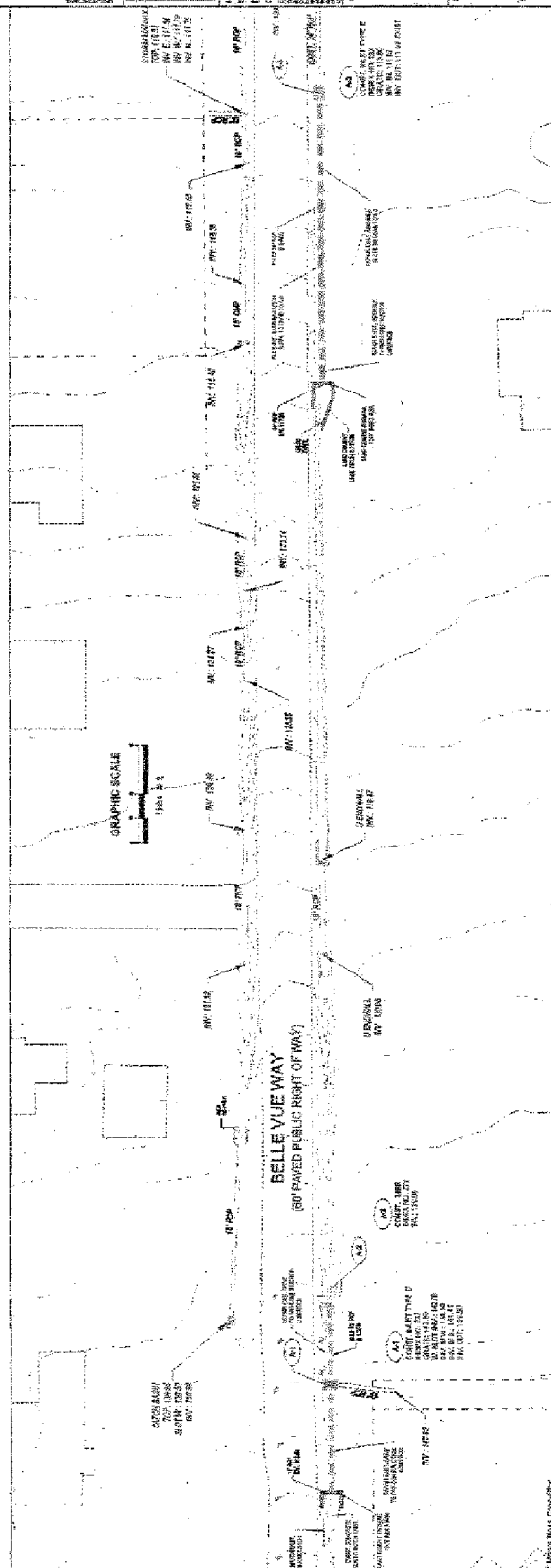
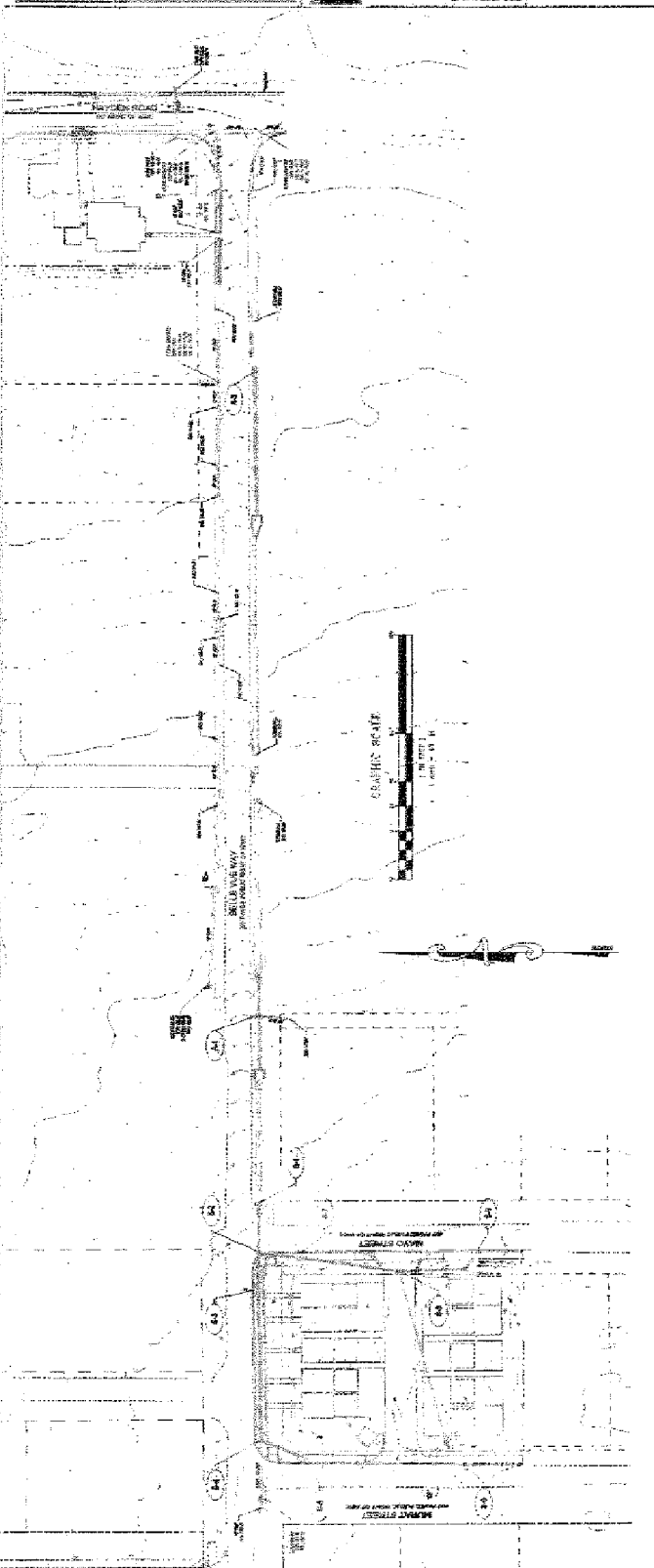

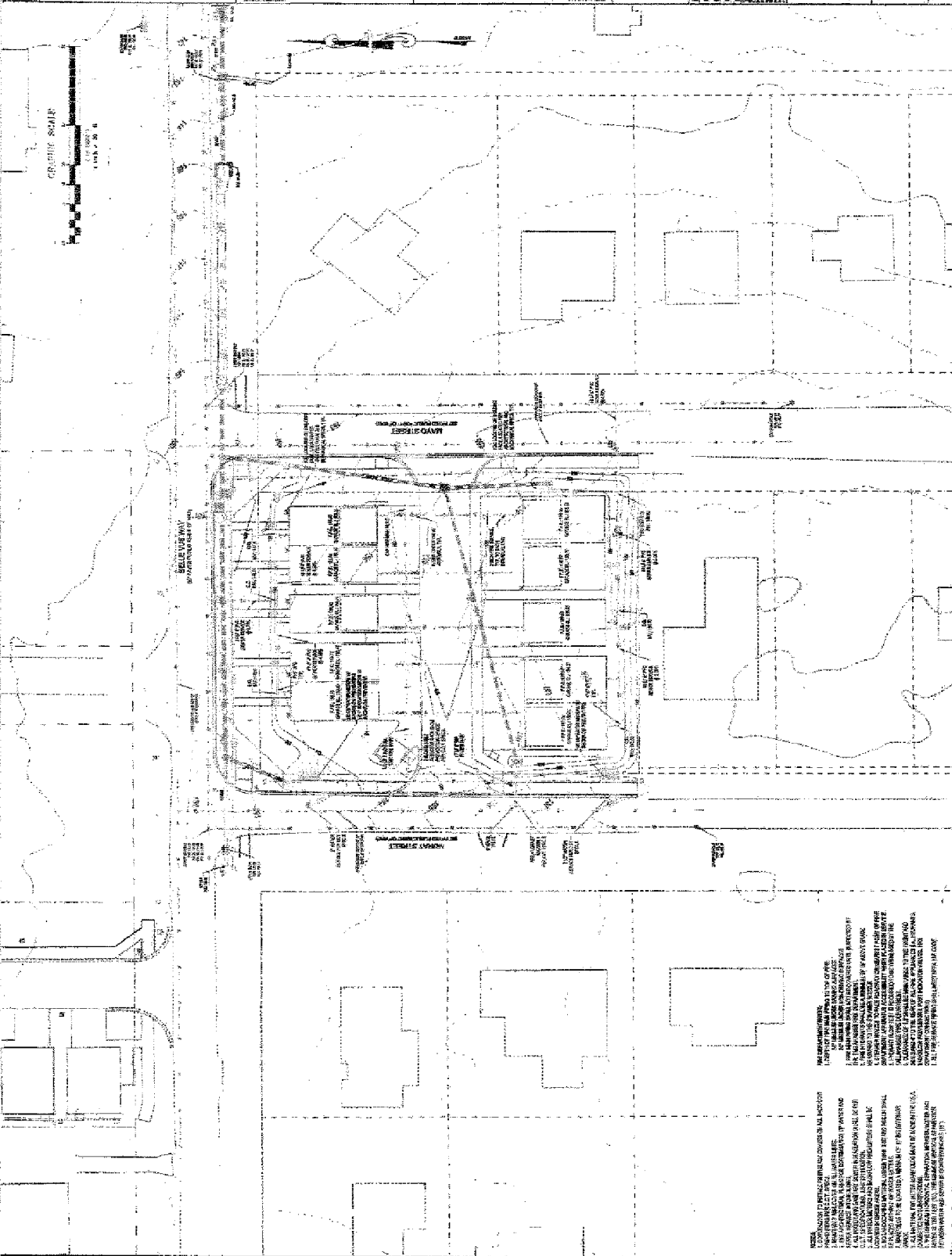

NOTES:

1. ALL DIMENSIONS ARE TO FACE UNLESS OTHERWISE NOTED.
2. ALL WALLS ARE TO BE CONSTRUCTED IN ACCORDANCE WITH THE 2000 INTERNATIONAL BUILDING CODE (IBC).
3. ALL WALLS ARE TO BE CONSTRUCTED WITH 1/2" GYPSUM BOARD ON BOTH SIDES OF THE STUD WALLS.
4. ALL WALLS ARE TO BE CONSTRUCTED WITH 1/2" GYPSUM BOARD ON ONE SIDE OF THE STUD WALLS AND 5/8" GYPSUM BOARD ON THE OTHER SIDE.
5. ALL WALLS ARE TO BE CONSTRUCTED WITH 1/2" GYPSUM BOARD ON BOTH SIDES OF THE STUD WALLS AND 5/8" GYPSUM BOARD ON ONE SIDE OF THE STUD WALLS.
6. ALL WALLS ARE TO BE CONSTRUCTED WITH 1/2" GYPSUM BOARD ON BOTH SIDES OF THE STUD WALLS AND 5/8" GYPSUM BOARD ON ONE SIDE OF THE STUD WALLS.
7. ALL WALLS ARE TO BE CONSTRUCTED WITH 1/2" GYPSUM BOARD ON BOTH SIDES OF THE STUD WALLS AND 5/8" GYPSUM BOARD ON ONE SIDE OF THE STUD WALLS.
8. ALL WALLS ARE TO BE CONSTRUCTED WITH 1/2" GYPSUM BOARD ON BOTH SIDES OF THE STUD WALLS AND 5/8" GYPSUM BOARD ON ONE SIDE OF THE STUD WALLS.
9. ALL WALLS ARE TO BE CONSTRUCTED WITH 1/2" GYPSUM BOARD ON BOTH SIDES OF THE STUD WALLS AND 5/8" GYPSUM BOARD ON ONE SIDE OF THE STUD WALLS.
10. ALL WALLS ARE TO BE CONSTRUCTED WITH 1/2" GYPSUM BOARD ON BOTH SIDES OF THE STUD WALLS AND 5/8" GYPSUM BOARD ON ONE SIDE OF THE STUD WALLS.

	PROJECT NAME CARLOS BLOOM	CLIENT NAME CARLOS BLOOM REALTY, LLC 2800 ROBERT CLAY DRIVE DELRAY BEACH, FLORIDA 33434		ARCHITECT MOORE BASS	DATE NOVEMBER 2011	SHEET TITLE 7.0
	PROJECT NUMBER 01111111	CLIENT NUMBER 01111111		ARCHITECT NUMBER 01111111	DATE NOVEMBER 2011	SHEET NUMBER 7.0

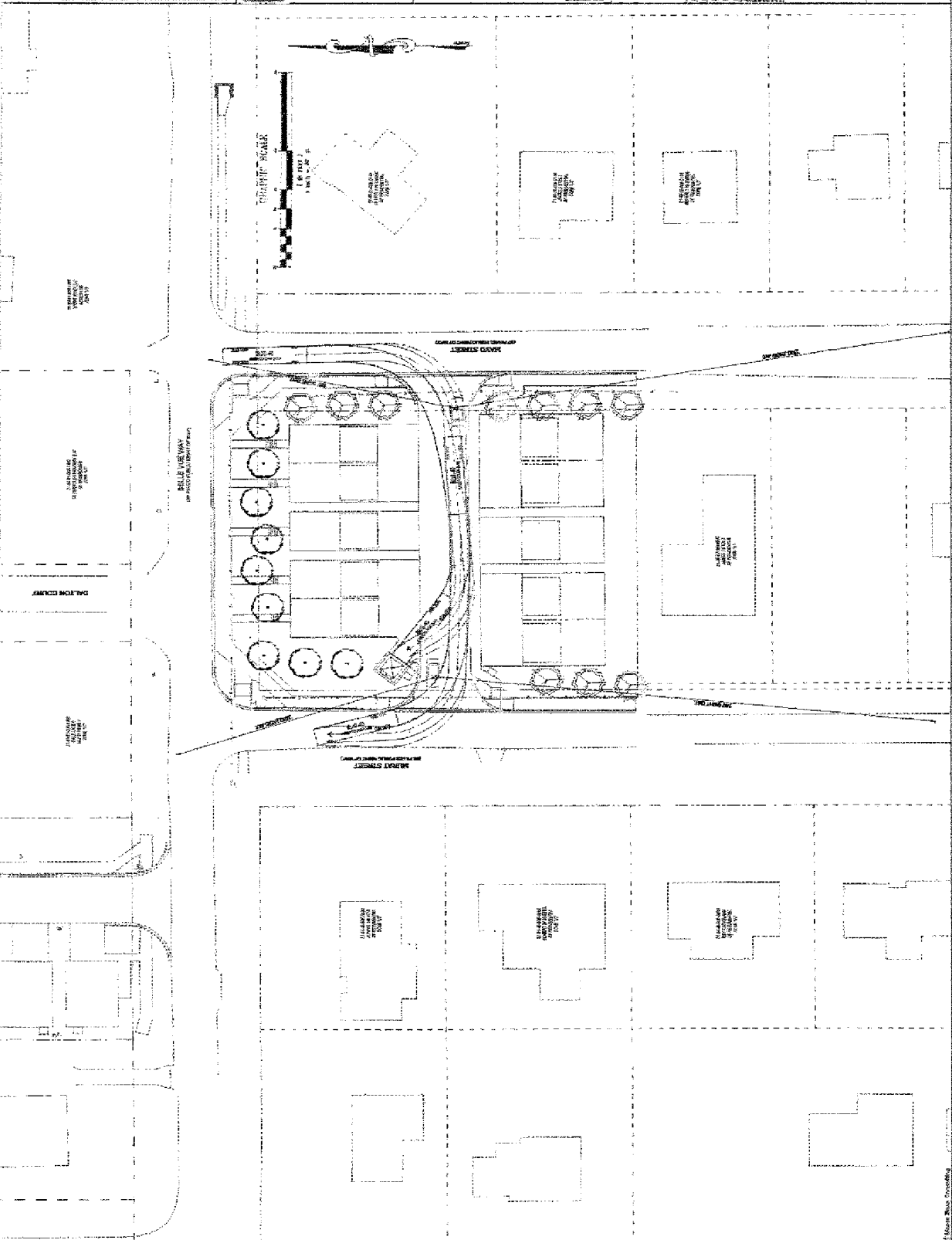

Moore Bass Consulting

Growth Management

- **Applications and Forms**
 - **Residential Permits**
 - **Permitting Process**
- **City Fast Tracking Initiative**
 - **City Projects**
 - **Fee Schedule**
- **Land Development Process**
 - **Building Inspection**
- **Building Inspection Reports**
 - **Meetings and Agendas**
 - **Concurrency**

Land Development Process

To develop property within the City of Tallahassee, you must determine that your project complies with all applicable development codes. The following page gives a brief description of the various steps in the review process. Review the [Team Area Map](#) to determine the Growth Management members to work with.

Land Use Compliance

The first step in the process is to determine if your project, at the location proposed, is an allowable use under the terms of the [Zoning Code](#). To do this, you must apply for a [Land Use Compliance Certificate](#). Your application must show where, what and how much you intend to build and what you intend to do with the finished project. The Growth Management Department will compare your proposed project with the land development standards for the property in question and determine if your project is allowable. The Land Use Compliance Certificate will specify what subsequent approvals your project must have.

Concurrency

There must be capacity in the public utilities and facilities to serve your project. Consequently, you must submit an [application for a concurrency determination \(PDF\)](#) to the Growth Management Department. The application must show the impact your project will have on public facilities, such as streets, water, sewer, solid waste, transit, stormwater and parks. Your project's impact will be compared with the available capacity of these facilities. If there is adequate capacity, you will receive a "Concurrency Certificate," which is required prior to any subsequent approvals. For further details, please contact the Concurrency Management Division of the Growth Management Department at 891-7100.

Natural Features Inventory

In order to preserve our natural environment, the Comprehensive Plan mandates that significant environmental features be identified and preserved prior to land development. For all sites that contain environmental features, an Natural Features Inventory (PDF) is required. This inventory, prepared by you and confirmed by the Growth Management Department, will identify and delineate all of the significant existing environmental features, such as wetlands, water courses, significant forests, endangered species, and sink holes. If your site does not contain environmental features, you may request an inspection and waiver (PDF).

Subdivision Approval

If a project consists of the subdivision of property so that individual lots can be sold, subdivision approval is required. The approval process, and time required, will vary based on the size of the subdivision and other factors.

Redevelopment

The City's land development codes provide special incentives for redevelopment projects, in the form of exemptions from some concurrency, stormwater, landscape, parking and buffer requirements.

Affordable Housing

The City's land development codes also provide special incentives for redevelopment projects that are planned and built to be affordable for families and individuals with incomes below the median income for Leon County. For more information on these incentives, please contact the Housing Assistance Division in the Department of Neighborhood and Community Services at 891-6500.

Site Plan Approval

Site plan approval is required for all projects except single family houses, duplexes, triplexes, quadraplexes and commercial projects of less than 1,000 square feet. Depending on the size of your project, its proposed use, its location and other factors, the approving authority and process will vary. The site plan process for your project will be specified on your Land Use Compliance Certificate.

Environmental Management Permits

After receiving your land use approval, in the form of a subdivision or site plan, you are ready to secure approval of your final construction plans, in the form of Environmental Management and Building permits. To apply for an Environmental Management permit (PDF), which will allow you to begin site work, you must show details of your stormwater systems and landscape plans. Further, you must show how you plan to protect the trees on your site and prevent erosion during construction. For more details, please contact the Environmental Services Division of the Growth Management Department at 891-7100.

Final Plat Recording

If your project involves the subdivision of property, it will be necessary for you to complete all public facilities and to submit a final plat of the subdivision prior to applying for any building permits. The public facilities will include the streets, stormwater ponds, water and sanitary sewer mains. The final plat must be approved by the Growth Management Department, the City Engineer, City Water Utilities and the City Commission and be recorded in the public records of Leon County. For more information, please contact the Land Use and Development Coordination Unit of the Growth Management Department at 891-7001 or the City Engineer at 891-8234.

Building Permit

To apply for your Building permit, you must submit detailed plans for the building, including plans for the structural, electrical, plumbing and mechanical systems. Separate permits will be required for each system.

Save yourself a trip to the courthouse and e-record directly from the City Growth Management's Records Management section! For your convenience, optional e-recording services are available for only \$7.50 (plus the regular County fees associated with recording services). This service includes e-recording of Notices of Commencement, Limited Partition Affidavits, Previously Established Land Use Conformities, Technical Amendments, easements, and other agreements. Notarized Affidavits of Originality can also be obtained for a fee of \$2.00. For more details, please contact the Applicant Services Unit of the Growth Management Department at 891-7125.

Certificate of Occupancy

A "Certificate of Occupancy," which will allow you to occupy your building, will be issued after you have completed all construction required by your permits and have paid all applicable permit and impact fees.

How Much Does It Cost?

The fees for each of the various land development processes will vary, depending on the size and whether it is a residential or commercial project. You may [download a copy of the fee schedule](#) (PDF). For an estimate of the fees for your project, please contact a Development Coordinator in the Growth Management Department, at 891-7001.

EXHIBIT V

TEM130003 AND REFERENCED TO THE PUBLIC RECORDS OF: TSP 120026, TSP130009, TPK 130003, , TBB122411, TBB124410, TBB 130329, TBB 130330, TBB 130331, TBB 130332, TBB 130333, TBB 130334, TCM130008, and TCM120046

The Campus Block stormwater system requires the excavation of existing soils that will cut and expose of the expansive clay vein common to the 304, 308, 312 and 316 Mayo properties causing damage to the adjacent property owners. The engineers of record must certify that said common soil will not drain and shrink beyond its current pre-redevelopment existing state and will not adversely cause damage or harm to the existing uphill 308 and 312 and 316 Mayo properties sharing said common expansive clay subsoil vein.

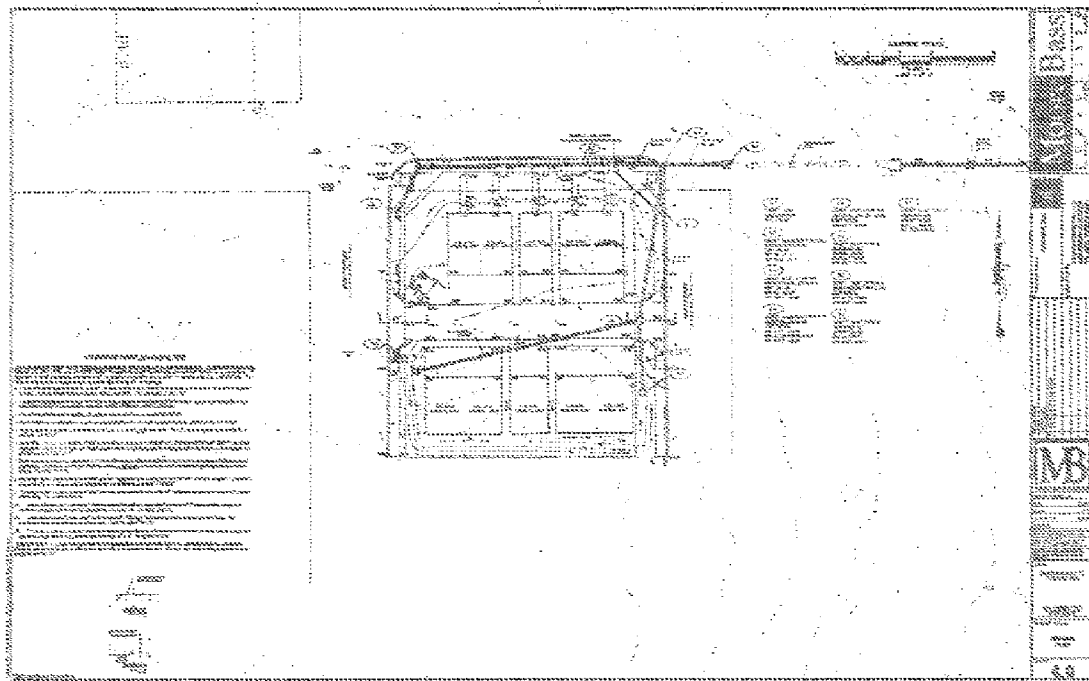

Proposed Stormwater system at southeast corner of Campus Block Grading Plan (southeast corner of 304 Mayo Street).

Y 71814X3

TBB130334, 304 Mayo Street Soil Boring Locations as completed in December 2012.



Expansive clay residue shown deposited on surface in front yard of 304 Mayo Street after building site soil borings completed in December 2012. Soil Boring located at rear southeast corner of proposed Campus Block Unit # 10 as seen in foreground and farther soil boring located at southwest soil boring hole of Campus Block Unit #9 as photographed before existing 304 Mayo Street house was demolished.



Expansive Clay boring residue from December 2012 shown as deposited on surface of 304 Mayo Street front yard.



Primarily expansive clay residue pulled from the December 2012 soil boring test located at 304 Mayo for TBB130334 Building Permit.

Soil borings have been completed as required for TBB130334.

The engineers have failed to respond and submit a planned mitigation to the proposed altering of the existing expansive subsoil common to Campus Block and the other existing Mayo Street properties.

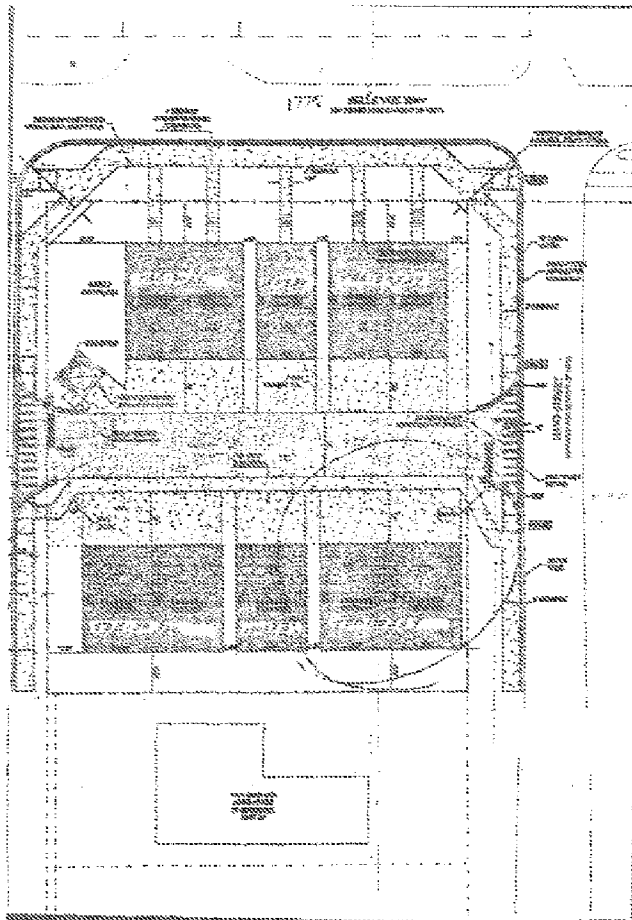

Building Permit TBB130334 on file.

The environmental review engineer has failed to sign off on TBB130334 and the other Campus Block building permits reviewed. The environmental review engineer appears to have allowed a non-registered engineer sign for the *Required Engineering Review*. Failure to review and address the adverse soil conditions located within the stormwater system will cause adjacent properties damage.

STAFF USE ONLY

		PERMIT FEE	
PARKING REQ'D <u>4</u>		Fees PD at APP <u>82.40</u>	ps
		Application <u>50</u>	
ZONING DIST. <u>Ux (mmrtd)</u>	CONSTR. TYPE <u>V-B</u>	Driveway Application <u>NA</u>	
		Expedited	
		Environmental	
FLOOD ZONE <u>Y 1(B)</u>	BLDG AREA <u>5350</u>	Driveway Connection <u>NA</u>	
		Building <u>1000.00</u>	
DIST. OF Flood Zone) <u>-</u>	HEIGHT <u>36</u>	S & E Control <u>214.08</u>	
		Water & Sewer <u>7824.00</u>	
PERM BASE SERV <u>-</u>	# OF STORIES <u>3</u>	State Surcharge <u>32.91</u>	
		Treating Surcharge <u>2.25</u>	
SUBSTANTIAL IMP <u>Y 1(B)</u>	# OF BEDROOMS <u>6 (2 each)</u>	Other	
		Other	
PC120050 TSPR002L PEM130003		PC130004	PERMIT FEE
IMPERVIOUS <u>3374</u>	# DRIVEWAY CONN	BALANCE DUE	<u>9097.97</u>

Required Review	Date of 1st Rev.	Date of 2nd Rev.	Final Approval
<input checked="" type="checkbox"/> Zoning	2/20/13 CES	2/22/13	C. Spiller
<input checked="" type="checkbox"/> Environmental	2/20/13 CES	2/22/13	C. Spiller for PL
<input type="checkbox"/> Gas			Gas
<input type="checkbox"/> Fire			FIRE
<input checked="" type="checkbox"/> Building	2/22/13 SES	2/27/13	SBP

APPLICATION STATUS, CONTACT INFORMATION & STAFF RECORDS:

Date/Reviewer	Comments
	Approved SP. no show 3 bath. these plans show 4 full baths. OK remove full bath in study.

The altering of subsoil conditions for the installation of a stormwater system will cause adverse effects and must be mitigated before damage is allowed to occur.

Leon County, 300 & 304 Mayo Street; Campus Block
 Soil Borings
 Project: 12S3-408D

BORING LOCATION FIGURE

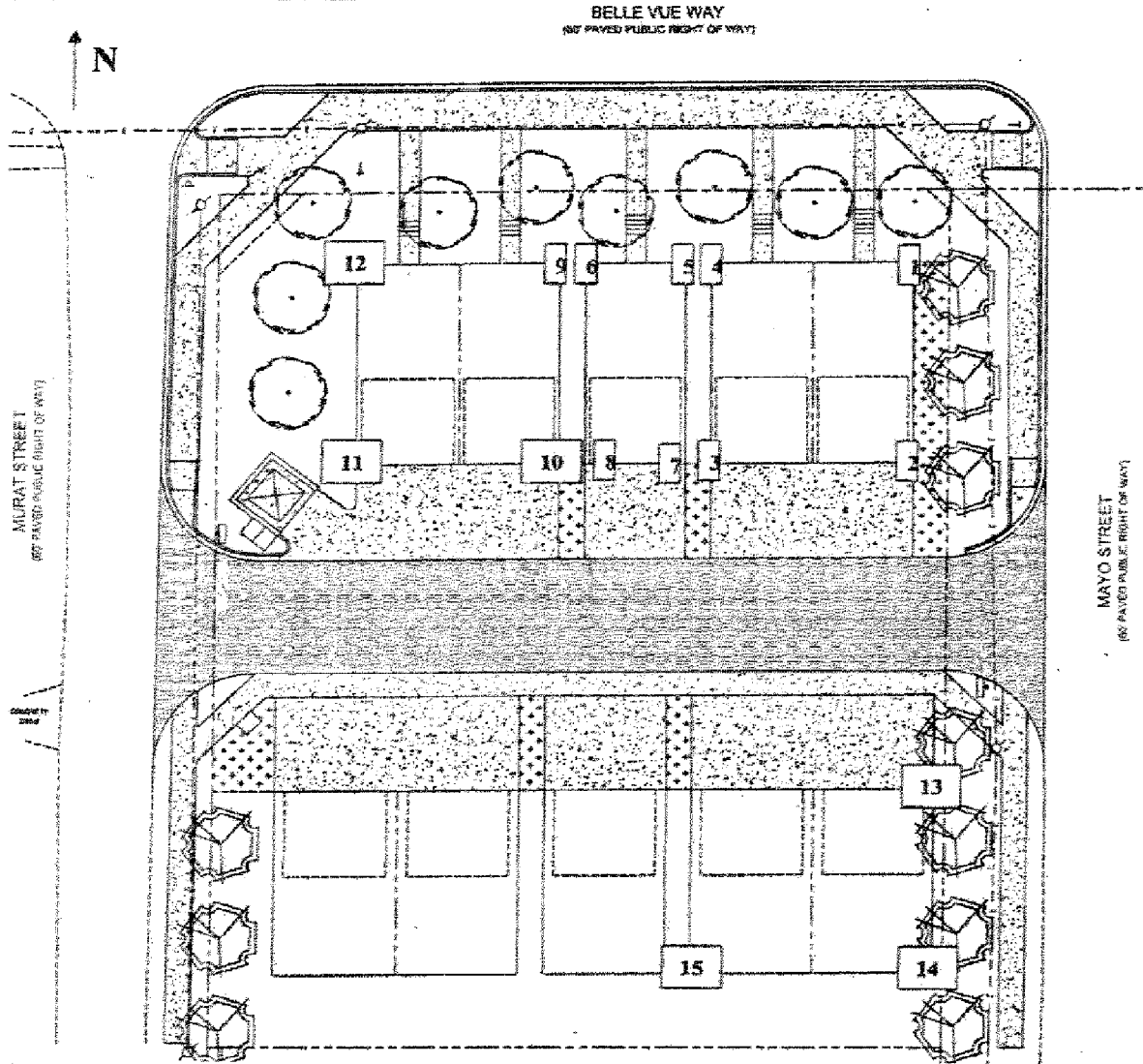

NOTE: Bold numbers located on Figure are approximate boring locations.
 Boring locations discussed with the Client.
 Figure source from MooreBass Consulting.
 Borings ≈ 24' wide by ≈ 42' long.
 Borings conducted by Simco 2400 Drill Rig.

C. Bourgeois Green 12-12-12
 Carmen Bourgeois Green, P.E. Date
 Florida P.E. No: 40890

53

Leon County, 300 & 304 Mayo Street; Campus Block
 Soil Borings
 Project: 12S3-408D

Boring Number	Depth (feet)		UNIFIED SYMBOL	SOIL DESCRIPTION AND DRILLING CONDITIONS
	FROM	TO		
14	0	0.5	SP-SW	Dark Brown Moist Sand with Roots (Topsoil)
	0.5	1	SP-SW	Dark Brown Moist Sand
	1	1.5	SC-SM	Brown Moist Slightly Clayey Sand
	1.5	4	SC-SM	Yellowish Brown/Reddish Brown Moist Moderately Clayey Sand
	4	6	SC-SM	Yellowish Brown/Reddish Brown/Light Gray Moist Moderately Clayey Sand
	6	10	CL-CH	Light Gray/Yellowish Brown Moist Pipe Clay <i>Groundwater Table Not Encountered</i>
15	0	0.5	SP-SW	Dark Brown Moist Sand with Roots (Topsoil)
	0.5	1	SC-SM	Brown Moist Slightly Clayey Sand
	1	4	SC-SM	Yellowish Brown/Reddish Brown Moist Moderately Clayey Sand
	4	10	CL-CH	Light Gray/Yellowish Brown Moist Pipe Clay <i>Groundwater Table Not Encountered</i>

GENERAL NOTES

- 1) Testing was performed at the location(s) indicated/flagged by the Client. Borings conducted using hand augers, Simco EP 200 drill rig, or Simco 2400 drill rig were performed as per ASTM D-1452.
- 2) Boring information provided in this report is based on the driller's logs, collected samples, and visual examination of soils in the field. Boring depths indicated are approximate. The Unified Soil Symbols are based on visual descriptions and estimates. Sieve analysis would be necessary to specifically identify the Unified Soil Symbol types. No inference of the approximate soil bearing capacities or soil compaction characteristics are made within this report.
- 3) Subsurface conditions are expected to vary from one location to the next. The borings provide a characterization of subsurface conditions at the test location; however, local variations are expected to occur, and significant differences in subsurface conditions may be encountered at other locations not tested. No inference is made regarding the presence or absence of karst or subsidence features.
- 4) Groundwater table elevations are representative of the conditions present at the time of testing. Groundwater tables are subject to fluctuation, depending on the amount of rainfall and other factors. The absence of a groundwater table does not mean it will not occur at the tested depth(s) under other conditions.

SITE NOTES

Due to site obstructions (existing building and fences), the southwest buildings could not be drilled at this time. Once the existing structures are demolished, S3 can further access the subject site.

Due to the presence of fat clay/elastic silt (locally referred to as "pipe clay") within a majority of the test borings, a specialized foundation is warranted/recommended for the buildings at this Site. Consultation with a foundation or civil engineer is recommended.

S3

4

March 31, 2013

PUBLIC RECORD INQUIRY FOR PENDING REQUESTED MAJOR MODIFICATION APPROVAL, TSP130009

REFERENCED TO THE PUBLIC RECORDS OF: TSP 120026, TPK 130003, TEM130003, TBB122411, TBB124410, TBB 130329, TBB 130330, TBB 130331, TBB 130332, TBB 130333, TBB 130334, TCM130008, TCM120046

Please Confirm or Deny the following 57 public review inquiries as they relate to the above referenced Public Record Submittals and as they relate to the proposed Campus Block Redevelopment proposed removal of two single family dwellings on two lots totaling 0.59 acre to add a 40 unrelated person apartment complex on a single 0.59 acre lot.

Mr. Brian Berry PE, Mr. Steve Palmer PE,

1. The Engineer of Record's (EOR's) November 8, 2012, TSP120026 Narrative requests the review of the redevelopment's sewer loads be based upon the applicant's submitted load for (10) three bedroom, three bath units.
2. The EOR's November 2012 submittal proposed a 4" on-site sewer line tapping into the existing 6" clay pipe Mayo Street sewer line.
3. The EOR's January 2013 submittal proposed a 6" on-site sewer line tapping into the existing 6" clay pipe Mayo Street sewer line.
4. The EOR's public record response states that the EOR is only responsible for the sizing of the Redevelopment sewer line up to the City's tap location.
5. A 6" smooth bore pvc pipe has a larger flow capacity than a 6" clay pipe sewer line.
6. On January 28, 2012, TSP120026, during the DRC hearing, the Campus Block *Site Plan had been approved for 10 multi-family dwelling units (30 beds) at a density of 16.94 units per acre.*
7. A February 21, 2013 email reply in regards to the Mayo Street sewer line calculations states, "The EOR based the calculations off of the number of units approved and stated above, which was 10 units. However, as stated in my previous email, *"The flows are not calculated using fixture counts but are based on flows outlined in the City of Tallahassee Concurrency manual, Appendix C and some internal design standards the City uses based on historical flow data for the City that are also part of the City specifications for water and wastewater."*
8. The Concurrency manual calculates the sewer load for each dwelling unit at 2.68 persons per unit.
9. Based on the Concurrency Manual, 10 dwelling units would calculate the proposed new sewer load as 26.8 persons for a total sewer load.

10. The applicant's website stated that Campus Block Redevelopment is a 40 bed 10 unit apartment complex.
11. The EOR stated that the Campus Block website was in error and that the Campus Block Redevelopment was for a 10 dwelling unit, 30 bedroom and 30 bathroom redevelopment.
12. February 27, 2013, the EOR requested approval for 10 dwelling units redevelopment with a proposed new sewer load of 40 bedrooms and 45 toilets.
13. March 1, 2013 Campus Block building permits were requested for 3 bedroom, 3 bath units.
14. The February 27, 2013 TSP130009 requests a Major Modification approval for (10) 4 bedroom, 4.5 bathrooms units.
15. The TSP 130009 DRC Review is scheduled for April 8, 2013 at 9 am.
16. Actual use sewer load calculations based on actual fixture loads were never calculated for the TSP120026 evaluation.
17. Written EOR calculations determining the actual sewer loads did not exist at the time of January 28, 2013 TSP120026 approval.
18. A February 21, 2013 email reply states, "The EOR gave me the flow demands but not the actual hand written calculations since they can be done very quickly on a calculator."
19. The EOR states in public record that their sewer design is used to reduce the number of sewer taps.
20. Written historic data in regards to the Mayo Street sewer line does exist.
21. The primary issue is not the structural integrity of the 6" clay sewer line.
22. The primary issue that remains is the flow capacity of the 6" clay sewer line and the fact that line blockage does occur.
23. Campus Block is proposing a change from single family residential to a multifamily 40 bedroom, 45 bathroom redevelopment on the same sewer system.
24. Campus Block Redevelopment has removed (2) single story single family two bedroom houses and is proposing a redevelopment of that property with 10 units with (5) of the three story four bedroom multifamily apartments that will dump their sewer waste through a single new 6" pvc tapped into the smaller capacity existing 6" clay pipe Mayo Street Sewer line.
25. Sewer lines are gravity feed waste systems that are vented at each dwelling connected to that system through their roof vent stacks.
26. Sewerage waste is primarily a liquid and when a liquid is confined in a piped system the sewerage flows or gravitates towards the lowest elevation in that street sewer line system.
27. The Mayo Street sewer line is a simple gravity feed system to remove waste.

28. The existing Mayo Street occupied dwellings on the east side of Mayo Street are tied into such a gravity waste system and have a finished floor elevation (FFE) of roughly 152'(+/-).
29. These existing eastside of Mayo Street single family dwellings FFE's are approximately four to six feet higher than the Mayo Street gravity sewer line.
30. The Mayo Street sewerage system has experienced inconvenience blockage in the past resulting in slow flushing toilets.
31. Mayo Street sewer line blockage has been and is random, never on a fixed schedule.
32. As of March 31, 2013, no incident of any sewerage back flow entering the eastside Mayo Street residences via their sewer line connections to the Mayo Street sewer line have been reported to the City.
33. Campus Block is requesting approval to add five (4) bedroom, three story structures that will tie into the Mayo Street, with five tubs, five hand sinks, five toilets, five washing machines at or above FFE 156'(+/-), five toilets, five hand sinks, five kitchen sinks, five garbage disposals, five bar sinks at the second floor elevation FFE 167'(+/-) and fifteen bathtubs, fifteen sinks, and fifteen toilets on the third level at FFE 177'(+/-).
34. The Campus Block apartments will have 20' - 10"(+/-) of above grade vertical sewer stacks that will dump into the Mayo Street sewer line which is roughly ten feet below the Campus Block grade level at FFE 146 (+/-)', the existing proposed Mayo Street sewer line tap location.
35. Campus Block apartments will have a five unit vertical sewerage stacking capacity of over 30 (+/-) feet above the existing Mayo Street sewer line, a full 34 (+/-) feet higher than the existing east side Mayo Street single family residences.
36. Liquid sewerage will seek to level itself within the piped system due to gravity.
37. When the Mayo Street sewer line does experience a blockage, the raw sewerage will naturally flow towards the lowest vented points in the system, the existing lower houses on the east side of Mayo Street.
38. Regardless of any downstream sewer line blockage location, the higher elevation Campus Block apartments can and will be able to continue to flush their sewerage waste into the sewer system due to the system being a vented sewerage system.
39. The back flow sewerage will naturally flow towards the lower dwellings already connected to the Mayo Street sewer system with no ill effects to the Campus Block dwelling units.
40. When the Mayo Street sewer line does experience a blockage, raw sewerage will back up and enter the existing eastside Mayo Street dwellings.

41. When the Mayo Street sewer line does experience complete blockage, raw sewerage will back up and enter the eastside Mayo Street dwellings thus placing the health, welfare and safety of the east side Mayo Street occupants at risk.
42. When the Mayo Street sewer line does experience a blockage, raw sewerage will back up and enter the eastside Mayo Street dwellings and these properties will be irreversibly damaged causing a loss in rental business operations and a loss in property value.
43. The avoidable harm to the health of any resident or occupant caused by the raw sewerage contamination will be a truly avoidable loss.
44. Redevelopment site plan reviews evaluate all design choices for their impact and consequences.
45. Campus Block has numerous design options with direct adjoining public right of way road and sewer line frontage on three sides of the proposed Campus Block Redevelopment.
46. Campus Block chose the design and layout of their site.
47. Campus Block has direct public right of way access with 504 linear feet of adjacent sewer line access on Murat Street, Belle View Way and Mayo Street.
48. Campus Block has the option of providing a new sewer line to connect directly to Belle View Way main sewer line.
49. Campus Block has the option of connecting their sewer line to the Murat Street sewer line.
50. Campus Block has the option of splitting their sewer line connections among three existing sewer lines.
51. Campus Block has chosen the least costly option for Campus Block through a gang connection of individual units to include 5 units to a single sewer line.
52. The Campus Block Mayo Street single sewer line connection does not appear to be based upon the best interest for the public good.
53. As the Development Review Manager and as a Florida Registered Professional Engineer you have the responsibility to review the Campus Block Mayo Street sewer tie-in proposal.
54. As the Development Review Manager and as a Florida Registered Professional Engineer you have the responsibility to determine if the Campus Block Mayo Street sewer tie-in proposal is in the best interest of the public.
55. As the Development Review Manager, you have the authority to approve the Campus Block Mayo Street sewer tie-in proposal.
56. The resulting redevelopment shall not be detrimental to the public good or to the surrounding properties.
57. Through said approval of the Campus Block Mayo Street sewer tie-in proposal you thereby certify that you see no potential harm or damage will occur to any persons or surrounding property by such approval.

RE: TSP130009 Campus Block Major Modification

From : Steven Palmer <Steven.Palmer@talgov.com> Tue, Apr 02, 2013 03:37 PM
Subject RE: TSP130009 Campus Block Major Modification  mayo
To : 'J Stolz' <jimstolz@centurylink.net>, Keith Burnsed <Keith.Burnsed@talgov.com>, Blas Gomez <Blas.Gomez@talgov.com>, Brian Berry <Brian.Berry@talgov.com>
Cc : Wayne Tedder <Wayne.Tedder@talgov.com>, Gail Shuffler <Gail.Shuffler@talgov.com>, Susan Poplin <Susan.Poplin@talgov.com>

Mr. Stolz- I am reviewing your email now, and I will get back with you as soon as I can after I've determined the best method for responding.

Steve Palmer, P.E.

Administrator, Land Use and Environmental Services Division
Growth Management Department
435 N. Macomb Street • Tallahassee, FL 32301
Office: 850.891.7095 • Steve.Palmer@talgov.com

From: J Stolz [<mailto:jimstolz@centurylink.net>]
Sent: Tuesday, April 02, 2013 11:32 AM
To: Palmer, Steven; Burnsed, Keith; Gomez, Blas; Berry, Brian
Cc: Tedder, Wayne; Shuffler, Gail; Poplin, Susan
Subject: TSP130009 Campus Block Major Modification

Please respond to the public inquiry for the TSP130009 April 8, 2013 DRC hearing and please include the inquiry and response as part of the public record.

thank you,
Jim Stolz
affected party



**THE CITY OF TALLAHASSEE
BUILDING INSPECTION DIVISION
PLUMBING PERMIT**



Address: 1775 BELLE VUE WAY T/LC
 Unit#: 8
 Contractor: ROBERT WEST JR PLUMBING INC
 Contractor Lic#: CFC057859
 Owner: CAMPUS BLOCK FSU LLC
 Occupant: CAMPUS BLOCK
 Parcel ID#: 2135220000010
 Type Imprv: NEW
 Class Bldg: SINGLE FAMILY DETACHED
 Permit#: TBP130461
 Valuation: \$0.00

Status: ISSUED
 Date Issued: 03/26/2013
 Issued By: GATESJ
 Inspector: MIKE FAGAN
 Insp Cell#: 933-8184
 Bldg Pmt#: TBB130333
 Shell Permit: N
 Historic (HPO) Site: N
 City Owned and Occupied: N

Permit Classification Fee: SINGLE FAMILY RESIDENTIAL
 Version of Code: FL Bldg Code 2010

DESCRIPTION	QTY	AMOUNT
APPLICATION FEE		\$54.00
ANNUAL FACILITY		\$0.00
FLXTURE COUNT \$8.57 X	20	\$171.40
BACKFLOW PREVENTOR	0	\$0.00
NEW SEWER INSTALLATION	1	\$8.57
GREASE TRAP		\$0.00
SOLAR WATER HEATING SYSTEM		\$0.00
POTABLE: N POOL: N		
COMMERCIAL SWIM POOL		\$0.00
WATER SERVICE INSPECTION		\$0.00
SEWER SERVICE INSPECTION		\$0.00
SEWER REPLACEMENT		\$0.00
MULTI-USE/FAMILY FIX COUNT	0	\$0.00
VIOLATION FEE	N	\$0.00
RE-INSPECT FEE	0	\$0.00
PERMIT EXTENSION	0	\$0.00
CONTRACTOR CHANGE	0	\$0.00
INSPECTOR HOURLY FEE		\$0.00
TRAINING SURCHARGE		\$2.50
STATE SURCHARGE		\$7.02
AAF		\$0.00
OTHER FEES ID	0	\$0.00
TOTAL FEE:		\$243.49
TOTAL PAYMENT:		\$243.49
BALANCE DUE:		\$0.00

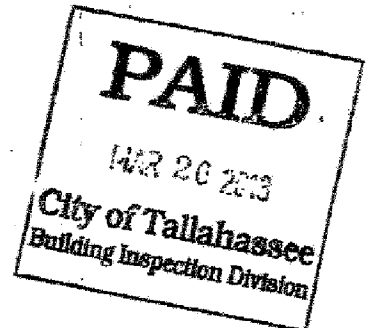

Notes: ST - NEW RES SFD

Signature: _____

Call (850) 891-1800 to schedule the following inspections:
 401 Rough-In Slab 402 Rough In 403 Tub Set
 404 Water Heater 407 Water Service 410 Backflow
 905 Plumbing Final

Call (850) 891-7040 to schedule:
 400 Sewer Inspection

2

Date: 3-26-13 Call Back #: 251-2827 Fax Back #: 514-3238
 Trust Acct #: _____ Plumbing Permit #: TBP 130461

SHELL PERMIT Building Permit #: TBB 130333

Application is herewith made for a plumbing permit covering a plumbing installation in or on the premises stated below. The applicant hereby agrees to perform such work in accordance with the requirements of the Florida Building Code.

NOTICE TO PLUMBING CONTRACTOR: ANY JOB VALUE GREATER THAN \$2,500.00 THAT IS NOT ASSOCIATED WITH A BLDG PERMIT WILL REQUIRE A NOTICE OF COMMENCEMENT BEFORE FIRST INSPECTION.

Plumbing Contr.: Robert West Jr. License #: CECO 57859

Job Address: 1755 Belle View UNIT # 8 Cost of Plumbing: \$ _____

Owner: Old Farm Parcel ID#: _____

A. TYPE OF IMPROVEMENT	C. CLASS OF BUILDING	(Proposed Use)	
01 NEW BUILDING	01 ONE FAMILY	09 WAREHOUSE	24 PUBLIC UTILITY
02 ADDITION	02 TWO FAMILY	13 SUBDIVISION	25 SCHOOL LIBRARY, EDUCATION
03 ALTERATION / REPAIR	03 TRIPLEX	15 BUSINESS	26 STORES, MERCANTILE
09 FOUNDATION ONLY	04 QUADRIplex	16 AMUSEMENT, RECREATIONAL	28 DAY CARE
10 SWIMMING POOL	05 MULTI FAMILY _____ units	17 CHURCH, OTHER RELIGIOUS	30 MULTI - USE
	06 ROOMING HOUSE _____ units	18 INDUSTRIAL	32 COMM ACCESSORY STRUCTURE
	07 HOTEL, MOTEL _____ units	19 PARKING GARAGE	37 RESTAURANTS
	08 DORMITORY _____ units	20 SERV. STATION, REP GARAGE	OTHER SPECIFY _____
	12 SINGLE FAMILY ATTACHED	21 HOSPITAL, INSTITUTIONAL	
	35 MOBILE HOME	22 OFFICE, PROFESSIONAL	

No. of Fixtures	Backflow Preventer	New Sewer Installation	Grease Trap	Price Each	Solar System	Price Each	Application Fee	Total Fee Due	Description
20	+	1	+	X \$ 8.57	+	X \$ 31.00	+\$ 54.00	=	New/Add 1 & 2 Family
	+		+	X \$ 8.03	+	X \$ 31.00	+\$ 54.00	=	Alteration 1 & 2 Family
	+		+	X \$ 4.55	+	X \$ 31.00	+\$ 127.00	=	New/Add Multi Family
	+		+	X \$17.41	+	X \$ 31.00	+\$ 127.00	=	New/Add Commercial
	+		+	X \$13.39	+	X \$ 31.00	+\$ 127.00	=	Alteration Multi Family & Commercial
				X \$40.00	+	X \$ 31.00	+\$ 127.00	=	Commercial Pool
backflow for pool is \$17.41 each									
						X \$ 32.00	+\$ 54.00	=	Water Service Inspection
						X \$ 32.00	+\$ 54.00	=	Sewer Service Inspection
						X \$ 32.00	+\$ 54.00	=	Sewer Replacement
						X \$ 31.00 (per panel)	+\$ 123.00	=	Solar Water Heating (STAND ALONE PERMIT)
							\$ 2.50		Training Surcharge
									State Surcharges
									243.49 TOTAL FEES

SOLAR SYSTEM BEING INSTALLED IS:
 POTABLE or POOL
 ROOF MOUNT or GROUND MOUNT

Rooming House, Hotel/Motel & Dormitory bldgs. can be charged as multi-family

Applicant Signature: [Signature] PLEASE CALL: 891-1800 FOR INSPECTIONS
 891-7040 FOR SEWER INSP.

5

W

April 28, 2013

Campus Block FSU Actual Sewer Load dumping into the Mayo Street Sewer line based on actual installed plumbing fixtures (DFU per FBC Section 709)

Campus Block has five (4) bedroom, three story structures that will tie into the Mayo Street, with five tubs, five hand sinks, five toilets, five washing machines at or above FFE 156'(+/-), five toilets, five hand sinks, five kitchen sinks, five garbage disposals, five bar sinks at the second floor elevation FFE 167'(+/-) and fifteen bathtubs, fifteen sinks, and fifteen toilets on the third level at FFE 177'(+/-). Each Unit uses a 4 inch PVC horizontal waste pipe that exits the units into a 6" PVC waste drain that is being tied into the existing smaller 6" clay Mayo Street sewer line.

Five 4 bedroom 4.5 bathroom units with actual installed number of fixtures and FBC Discharge Fixture Unit count as per FBC Sanitary Drainage, Section 709 Fixture Units, Table 709.1 Drainage Fixture Units for Fixtures and Groups, Fixture Type and Drainage Fixture Unit Value as Load Factor (DFU)

4 bath tubs	DFU 2 each	8 total
5 bathroom hand sinks	DFU 1 each	5 total
5 toilets	DFU 3 each	15 total
1 kitchen sink with garbage disposal with dishwasher	DFU 2 each	2 total
1 bar sink	DFU 1 each	1 total
1 washing machine	DFU 2 each	2 total

Campus Block each Unit installed Drainage Fixture Unit Load: 33 DFU's

FBC Section P3111, P3111.3 Size of Combination Waste and Pipe Horizontal Branch maximum number of Fixture Units DFU Diameter of Pipe (inches) allowable per unit 4 inch pipe installed: 20 DFU

Issued Plumbing Permits example: TBP130461 for TBB130333

Campus Block Apartment Unit Drainage Fixture Unit listed Load:	20 DFU
Actual DFU installed per Unit	33 DFU
Issued Plumbing Permit is undersized for installed DFU Loads:	(13 DFU)

Five Units tied into Mayo Street Sewer line, permit undersize: (65 DFU)

April 8, 2013 TSP130009 Condition of Approval, Signed and Sealed Sewer Load Calculations are not posted in the public record file, yet, construction continues.

2

W

fixture drain shall connect to the combination waste and vent within a distance specified in Table P3105.1. The combination waste and vent pipe shall be considered the vent for the fixture.

P3111.3 Size. The minimum size of a combination waste and vent pipe shall be in accordance with Table P3111.3.

**TABLE P3111.3
SIZE OF COMBINATION WASTE AND VENT PIPE**

DIAMETER PIPE (inches)	MAXIMUM NUMBER OF FIXTURE UNITS (d.f.u.)	
	Connecting to a horizontal branch or stack	Connecting to a building drain or building subdrain
2	3	4
2½	6	26
3	12	31
4	20	50

For SI: 1 inch = 25.4 mm.

SECTION P3112

Pipe.
P3113.2
ual, bran
these po
point of
outside

P3113.3
common
accordan
horizont
the total

P3113.4
accordan

P311
than
be ve
Build
sewa
in ac

P311
solid

4

CenturyLink Webmail

jimstolz@centurylink.net

Campus Block signed and sealed water and sewer calculations

From : J Stolz <jimstolz@centurylink.net>

Mon, May 27, 2013 10:52 AM

Subject : Campus Block signed and sealed water and sewer calculations

 1 attachment

To : Brian Berry <Brian.Berry@talgov.com>, Blas Gomez <Blas.Gomez@talgov.com>, Steven Palmer <Steven.Palmer@talgov.com>

Cc : Dean Kindley <Dean.Kindley@talgov.com>

Bcc : jasonstolz <jasonstolz@hotmail.com>

Public record inquiry request for the April 8th 2013 DRC, Campus Block approval with conditions, signed and sealed Water and Sewer Calculations. Please provide the Public Record location of the Campus Block signed and sealed Water and Sewer Calculation files.

AND please add the attachment to the TSP13009 public record file.

Thank you.

 **CampusBlock sewer.docx**
18 KB

May 23, 2013
Brian Berry PT, Steven Palmer PE, Blas Gomez PE
City of Tallahassee Development Review

RE: Campus Block Apartments, TSP120026 and TSP130009 Reviews

Florida Building Code Plumbing 2010

CHAPTER 7

SANITARY DRAINAGE

SECTION 701

GENERAL

701.1 Scope.

The provisions of this chapter shall govern the materials, design, construction and installation of sanitary drainage systems.

701.3 Separate sewer connection.

*Every building having plumbing fixtures installed and intended for human habitation, occupancy or use on premises abutting on a street, alley or easement in which there is a public sewer shall have a separate connection with the sewer. **Where located on the same lot**, multiple buildings shall not be prohibited from connecting to a common building sewer that connects to the public sewer.*

(2010 FLORIDA BUILDING CODE — BUILDING
USE AND OCCUPANCY CLASSIFICATION

SECTION 310

RESIDENTIAL GROUP R

310.1 Residential Group R.R-2.

Residential occupancies containing sleeping units or more than two dwelling units where the occupants are primarily permanent in nature, including: Apartments.)

Campus Block has been permitted as single family residential and duplex residential occupancy classification (TBB130329, TBB130330, TBB130331, TBB130334, TBB130333, TBB130334). As permitted each Campus Block unit must provide separate connections to the public sewer or ten sewer taps. When located on the same lot, multiple buildings can connect to a common building sewer. Multiple buildings are defined by more than two units per lot, are classified as FBC are R-2 Occupancy, Apartments. The submitted DRC documents states Campus Block are multifamily apartments. What occupancy classification was used for the approval of the sewer review for TSP120036 and TSP13009?

SECTION 709

FIXTURE UNITS

709.1 Values for fixtures.

Drainage fixture unit values as given in Table 709.1 designate the relative load weight of different kinds of fixtures that shall be employed in estimating the total load carried by a soil or waste pipe, and shall be used in connection with Tables 710.1(1) and 710.1(2) of sizes for soil, waste and vent pipes for which the permissible load is given in terms of fixture units.

The drainage fixture unit load of an indirect waste receptor receiving the discharge of indirectly connected fixtures shall be the sum of the drainage fixture unit values of the fixtures that discharge to the receptor, but not less than the

drainage fixture unit value given for the indirect waste receptor in Table 709.1 or 709.2.

Campus Block FSU Actual Sewer Load dumping into the Mayo Street Sewer line based on actual installed plumbing fixtures (DFU per FBC Section 709)

Campus Block has five (4) bedroom, three story structures that will tie into the Mayo Street, with five tubs, five hand sinks, five toilets, five washing machines at or above FFE 156'(+/-), five toilets, five hand sinks, five kitchen sinks, five garbage disposals, five bar sinks at the second floor elevation FFE 167'(+/-) and fifteen bathtubs, fifteen sinks, and fifteen toilets on the third level at FFE 177'(+/-). Each Unit uses a 4 inch PVC horizontal waste pipe that exits the units into a 6" PVC waste drain that is being tied into the existing smaller 6" clay Mayo Street sewer line.

Five 4 bedroom 4.5 bathroom units with actual installed number of fixtures and FBC Discharge Fixture Unit count as per FBC Sanitary Drainage, Section 709 Fixture Units, Table 709.1 Drainage Fixture Units for Fixtures and Groups, Fixture Type and Drainage Fixture Unit Value as Load Factor (DFU)

4 bath tubs	DFU 2 each	8 total
5 bathroom hand sinks	DFU 1 each	5 total
5 toilets	DFU 3 each	15 total
1 kitchen sink with garbage disposal with dishwasher	DFU 2 each	2 total
1 bar sink	DFU 1 each	1 total
1 washing machine	DFU 2 each	2 total

Campus Block each Unit installed Drainage Fixture Unit Load: 33 DFU's

FBC Section P3111, P3111.3 Size of Combination Waste and Pipe Horizontal Branch maximum number of Fixture Units DFU Diameter of Pipe (inches) allowable per unit 4 inch pipe installed: 20 DFU

Issued Plumbing Permits example: TBP130461 for TBB130333
 Campus Block Apartment Unit Drainage Fixture Unit listed Load: 20 DFU
 Actual DFU installed per Unit 33 DFU
 Issued Plumbing Permit is undersized for installed DFU Loads: (13 DFU)

Five Units tied into Mayo Street Sewer line, permit undersize: (65 DFU)

The April 8, 2013 TSP130009 Condition of Approval required Signed and Sealed Water and Sewer Load Calculations. Where in the public record file are the Campus Block signed and sealed Water and Sewer Load Calculations?

Webmail

jimstolz@centurylink.net

Re: Campus Block signed and sealed water and sewer calculations

From : J Stolz <jimstolz@centurylink.net> Fri, May 31, 2013 10:59 PM
Subject : Re: Campus Block signed and sealed water and sewer calculations
To : Brian Berry <Brian.Berry@talgov.com>
Cc : Dean Kindley <Dean.Kindley@talgov.com>, Hetal Desai <Hetal.Desai@talgov.com>, Blas Gomez <Blas.Gomez@talgov.com>, Steven Palmer <Steven.Palmer@talgov.com>

Thank you for the document.

I just wish to clarify the basis of the approval. The 10 unit 3 bedroom, 3 bath sewer calculation 13006S approval dated 2/20/13 have been signed, sealed, submitted, and calculated at 2.38 occupants per three bedroom apartment based on the 1973 sewer loading tables for all residential units regardless of size or location. The actual Campus Block on-site and in-use sewer load will exceed the 2/19/2013 sewer loading calculations submitted for approval. On April 8, 2013 the Campus Block DRC review increased the apartment development from three bedroom, three bath to four bedroom 4.5 bath per unit. No new calculations are required although the actual sewer load for four bedrooms is 60% larger than the submitted sewer load calculations that will remain calculated at 2.38 occupants per unit.

Is this correct?

Jim Stolz
affected party

From: "Brian Berry" <Brian.Berry@talgov.com>
To: "J Stolz" <jimstolz@centurylink.net>, "Blas Gomez" <Blas.Gomez@talgov.com>, "Steven Palmer" <Steven.Palmer@talgov.com>
Cc: "Dean Kindley" <Dean.Kindley@talgov.com>, "Hetal Desai" <Hetal.Desai@talgov.com>
Sent: Friday, May 31, 2013 9:14:16 AM
Subject: RE: Campus Block signed and sealed water and sewer calculations

Mr. Stolz,

Attached is a copy of the water and sewer calculations you requested.

Thank You,
Brian Berry, P.E.
Development Review Manager
City Of Tallahassee – Underground Utilities

Water Resources Engineering Division
300 South Adams St, B-26, Tallahassee, FL 32301
Office: 850-891-6140, Cell: 850-694-0331, Fax: 850-891-6170
<<mailto:brian.berry@talgov.com>>

From: J Stolz [<mailto:jimstolz@centurylink.net>]
Sent: Monday, May 27, 2013 8:53 AM
To: Berry, Brian; Gomez, Blas; Palmer, Steven
Cc: Kindley, Dean
Subject: Campus Block signed and sealed water and sewer calculations

Public record inquiry request for the April 8th 2013 DRC, Campus Block approval with conditions, signed and sealed Water and Sewer Calculations. Please provide the Public Record location of the Campus Block signed and sealed Water and Sewer Calculation files.

AND please add the attachment to the TSP13009 public record file.

Thank you.

EXHIBIT X

For the Parking Standards Committee review TPK130003, TSP120026, TSP130009;

The proposed redevelopment parking scheme of Campus Block is inadequate. Previous review of Campus Block redevelopment, TSP120026, had been based on the applicant's submittal stating that 30 tenants will occupy this single redeveloped parcel. Based on the engineer of record, 20 parking spaces had been proposed for 30 tenants.

TSP130009 is a major modification of TSP 1200026, and now requests that 40 tenants be approved, although there will be no increase in parking with the same 20 parking spaces now being proposed for now 40 unrelated tenants.

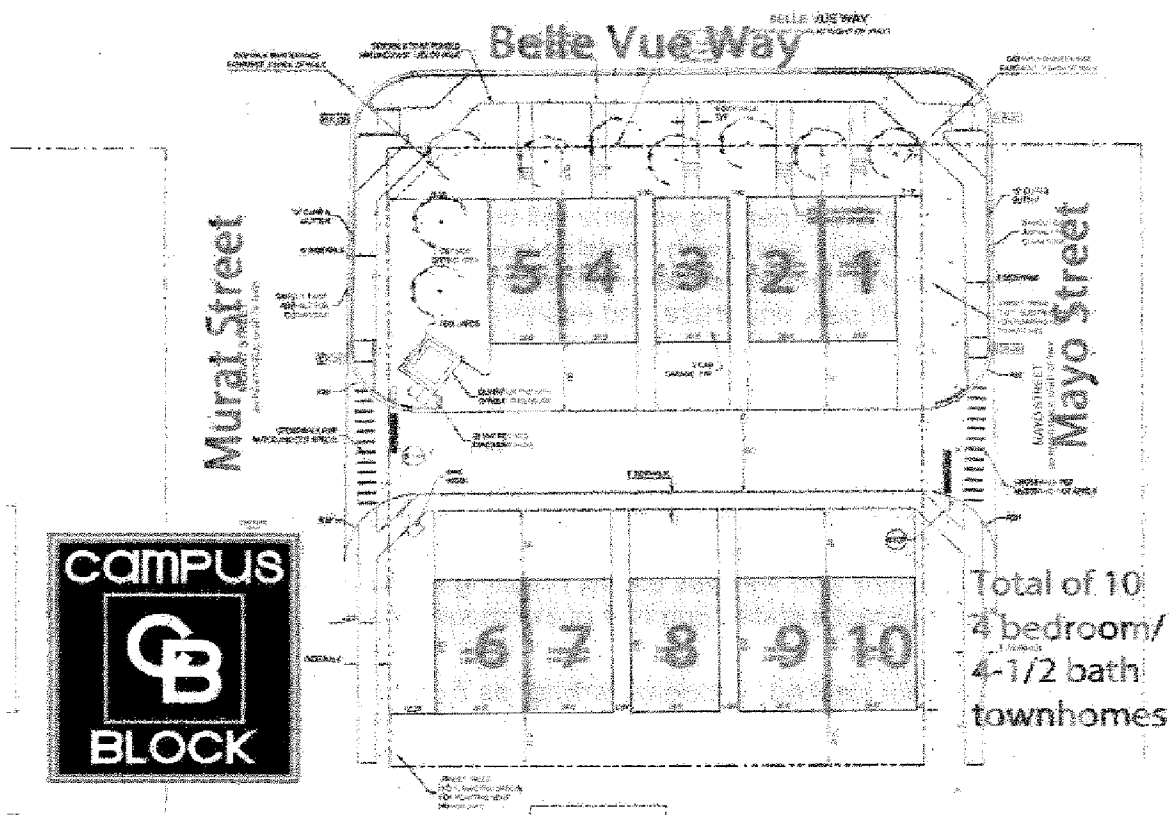

(source: Campus Block FSU website) **One single parcel with (10) multifamily units.**

The proposed Campus Block FSU development is (for 40 unrelated tenants) on a single 0.59 acre redevelopment lot with just 20 parking spaces being provided, AND, the applicant has even proposed the complete elimination of all existing street parking on Murat Street, Belle Vue Way and Mayo Street. The proposed center drive is 141 feet long, 24 feet wide and lined with 20 foot deep driveways providing a total of 20 parking spaces. No curbside parking area anywhere, no guest spaces, no handicap parking spaces, just 20 parking spaces for tenants and their guest.

11/10/2015

The proposed TSP130009 major modification now asks to allow 40 unrelated tenants on the single parcel lot. The Parking Standards Committee has been asked to review TPK130003 and grant a variance for the proposed redevelopment that will not meet *Article IV Table 8A Code's on-site parking requirements* nor *Section 10-284.5 Parking Location Standards (b) (1)* states: *On-street parking shall be provided on all streets with adequate public right of way (Sec -285 Table 2A)* and is proposed to provide just 20 accessible surface parking spaces for 40 bedrooms with no handicap spaces and no visitor spaces provided. Campus Block has 504 linear feet of road frontage on three streets, yet not one on-street parking space has been provided, WHY?

The applicant apparent choice to completely ignored Division 4 of the Code is being compounded by further appearing to completely eliminate of all current legal on-street perimeter vehicle overflow parking on all three redevelopment road frontages. Not only is street parking not being provided with the redevelopment but, all the existing legal street parking has been and will be completely eliminated.

The proposed Campus Block parking scheme will create Life and Safety Hazards for the Campus Block residents along with hardship and Life and Safety Hazards for the surrounding Mayo, Murat, and Belle View residents and for the general public that will be in the area. They will park anywhere and everywhere. Life safety issues must be, must be properly considered and addressed and take precedence.

The multifamily proposed Campus Block parking scheme now under review will likely result in MMTD road lane blockage, public local road lane blockage, dumpster blockage, illegal parking on sidewalks, illegal parking in the road, illegal parking on other private property, illegal driveway blockage, emergency vehicle blockage, vehicle line of sight impedance and an overall chaotic mix of bicycles, skateboards, pedestrians and vehicles clearly resulting in Life Safety and Health Hazards with the applicant's stated purpose of the request for variance is "aesthetics"?

The applicant requests stacked "*Tandem Parking*" as a code variance, but stacked "*Tandem Parking*" is not allowed for multifamily developments... only used *elsewhere*?

There is no hardship stated or otherwise for not requiring Campus Block to abide to just the minimum Code standards. What will be the public good of the variance, if the variance raises the risk that someone will get injured? What could be used as an argument to defend the variance waiver of the minimum code safety standards?

Life Safety takes priority over aesthetics..... every time.

Public safety requires that the parking design reflect the actual use and the Code specifically requires for this redevelopment that more parking spaces be on-site and more parking to be provided on-street.

As a matter of Life Safety and for the good of the community, the Parking Standards Committee must reject the proposed parking variance request and require the that the bare minimum 4 bedroom multifamily Code on-site and off-street parking requirements be implemented and applied to the Campus Block Redevelopment project.

APPENDIX

Parking Standards Committee review of TPK130003, with example of "Tandem Parking" in use; 1864 West on Belle Vue Way, a single parcel multifamily development where either a variance for "tandem parking" was created or this project was permitted just as a 3 bedroom development? TSP110042 - 1864 West is on a single 0.91 acre lot with (11) 4 Tenant per unit student rentals with garages and two designated driveway parking spaces per unit.

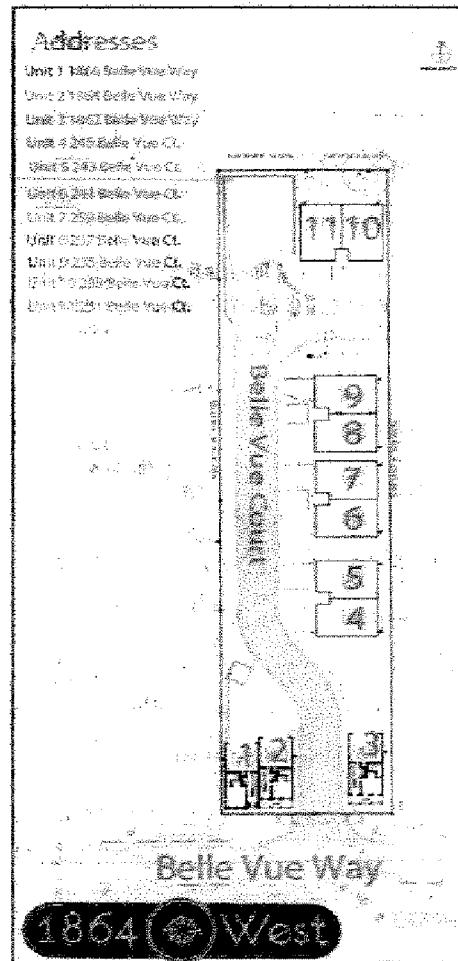

(Source: 1864 West.com)



Photo of 1864 West development with tandem parking looking north to Belle Vue Court from development intersection at Belle Vue Way. Jeep parked on sidewalk at 1864 West Unit #2, and silver sedan with dark wheels is blocking emergency access to 1864 West Units 4-11.



Belle Vue Court, note dumpster located behind, as seen through Jeep windshield.



Belle Vue Court looking north just past 1864 West Unit # 3 and dumpster, curved sidewalk on right start of Unit #4. Note the ignored no parking signs on left side of Belle Vue Court due to lack of tenant parking providing only 22 spaces with "tandem parking" 11 double width garages for 44 tenants.



Belle Vue Court in front of 1864 West Unit # 7 looking south at Units 1 and 2 with illegally parked tenant vehicles on west side of Belle Vue Court.

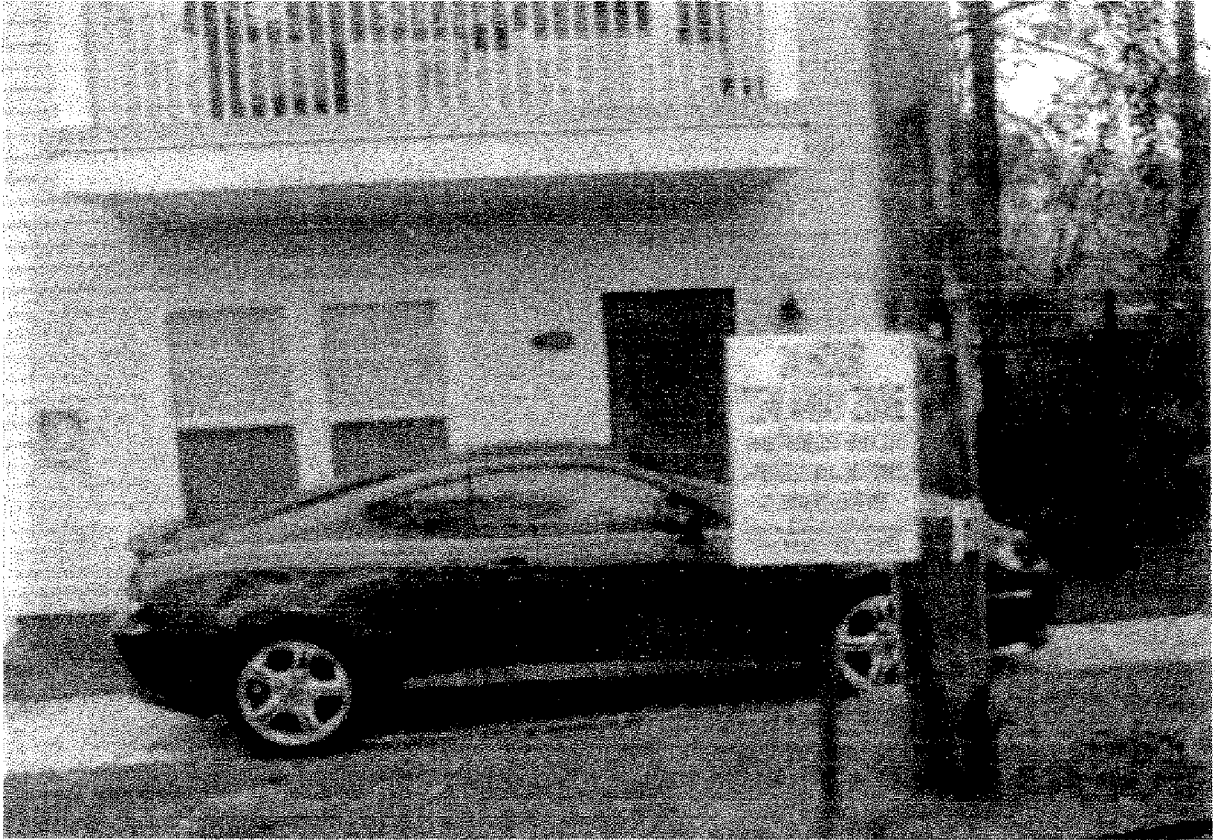

1864 West has nearly twice the land area as Campus Block, and no long access drive, where will the Campus Block residents and their guest park with just 20 surface parking spaces being provided??????????

Anywhere they choose regardless of forcing pedestrians into the street.....

1864 West Unit #3 on Belle Vue Way, Tenant parking on and blocking the public sidewalk.



Note grass is well worn from tire wear.



1864 West side of Unit #4, looking north on Belle Vue Court. Note sedan blocking pedestrian sidewalk forcing pedestrians into the street.



1864 West looking south, note illegal parking and white Toyota Tundra at end blocking the dumpster.

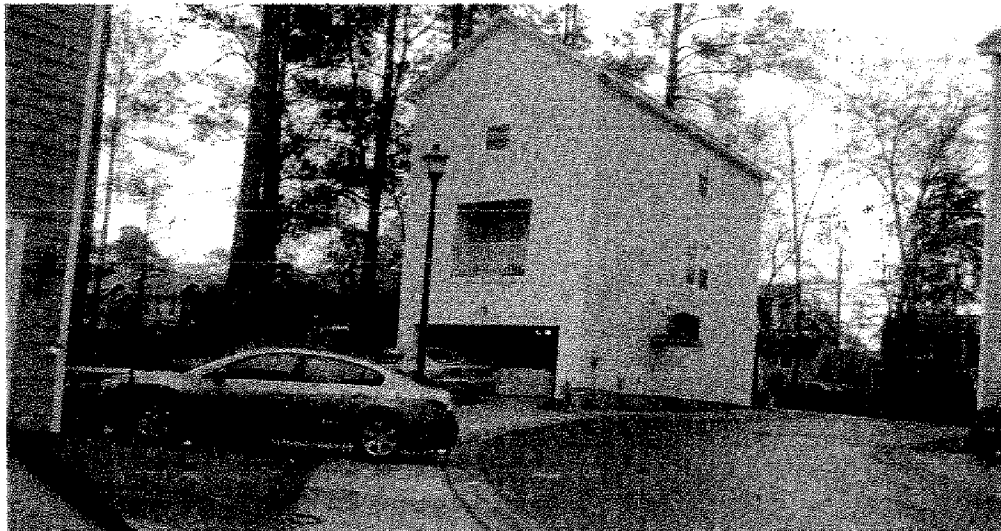

1864 West looking southeast towards Unit #3 with the open garage, note use of garage as Tenant's recreation room or storage area, not garage parking. There is no Code to enforce "Tandem Parking".

The previous photos were taken during the day on two occasions and do not reflect peak parking load hours. Stacked "Tandem Parking" does not work for student tenant rentals.



Overflow illegal student parking on private property, a vacant Belle Vue Way lot with 1864 west in background on right. Lack of adequate Redevelopment parking has a negative impact on public good and surrounding properties.

Tandem parking does not work for multifamily development and that is why it is not allowed by Code or ordinance (except for staff overlooking life safety and granting special privileges to a select few
.....Campus Block and 1864 West.....



A student townhome community.



- **ZERO SECURITY DEPOSIT FOR ALL LEASES SIGNED IN FEB.**
- **4 BEDROOM / 4-1/2 BATH STUDENT TOWNHOMES, OVER 2,000 SF**
- **GRANITE COUNTER TOPS, STAINLESS APPLIANCES, WOOD FLOORS**
- **2 CAR GARAGES, 2 CAR DRIVEWAY, PARK NEXT TO FRONT DOOR, ALARM**
- **COMMON AREA FURNISHED (2 FULL SIZE SOFA'S, COFFEE AND END TABLE, 4 BAR STOOLS, DINING TABLE WITH 4 CHAIRS)**
- **BUILT IN 2012**
- **LEASING NOW FOR 2013/2014**
- **\$605 PER BED FURNISHED**
- **\$595 PER BED UN-FURNISHED**

Call Owner Pat Chisholm for more information 407-923-8366
www.1864west.com



(Source: 1864west.com)

Stacked Tandem Parking does not work for student tenant rentals. Require the Code minimums.

TPK 130003

CITY OF TALLAHASSEE

PARKING STANDARDS COMMITTEE REVIEW

RECEIVED FEB 26 2013 GROWTH MANAGEMENT

This application should be submitted to the Growth Management Department, Division of Land Use & Environmental Services. Submittal must include the following items:

- Completed Application Form (original)
- Completed Owner's Affidavit (original)
- Parking study/justification statement providing a basis for the request.
- Fully-dimensioned traffic circulation/parking plan at a scale sufficient to show all of the necessary information to conduct a review.
- Color documents should also be submitted in electronic form in one of the following formats: .tif, .pdf, .jpeg, or .bmp.
- Filing fee of \$345.00.

1. Property Owner's Name: Campus Block FSU, LLC
Mailing Address: 2460 Forest Club Drive
Orlando, FL 32804
Telephone/Fax Number: (407) 923-8366
E-Mail Address: pat@plcpartnersllc.com
2. Applicant's (Optionee) Name: Same as Owner
Mailing Address:
Telephone/Fax Number:
E-Mail Address:
3. Agent's Name: Moore Bass Consulting, Inc.
Mailing Address: 805 N. Gadsden Street
Tallahassee FL 32303
Telephone/Fax Number: (850) 222-5678
E-Mail Address: ebass@moorebass.com
4. Parcel Identification Number: 21-35-22-000-001-0
5. LUCC #: TCC120050
6. Project Name: Campus Block
7. Is this a Resubmittal? Yes No
8. Zoning District: UT
9. Land Use Type: X 01-Residential Multi-Family 05-Restaurant
02-Non-Medical Office 06-General Retail
03-Medical Office 07-Light Industrial
04-Institutional 08-Heavy Industrial

Growth Management Department | Land Use & Environmental Services Division | Phone: (850) 891-7100 | Fax: (850) 891-7184
Location: 435 N. Macomb Street, Tallahassee, FL 32301 | Mailing: 300 S. Adams Street, Box B 28, Tallahassee, FL 32301

10. Parking Standards Committee review is being requested for (check all that apply):

- a. An increase from the specified on-site parking requirements.
- b. A decrease from the specified on-site parking requirements.
- c. A request for pervious parking.
- d. A modification to the Off-Street Parking Space Standards
- e. Other (Specify): Tandem Parking

	Required	Proposed
11. Number of Parking Spaces:	<u>20-27</u>	<u>40</u>
Number of Bicycle Spaces:	<u>10</u>	<u>10</u>
Number of Loading Berths:	<u>N/A</u>	<u>N/A</u>

Note: Pursuant to the *City of Tallahassee Land Development Code*, no parking space required for the handicapped shall be counted as a parking space in determining compliance with the *City of Tallahassee Land Development Code*.

12. This request is being filed in conjunction with or in anticipation of the following:

- Construction of a New Building(s) Reuse of an Existing Building
- Expansion of an Existing Building(s) Other (Specify): _____

13. Pursuant to the *City of Tallahassee Land Development Code*, check the public interest(s) that is to be served as a result of the parking standard modification:

- Environmental Protection Aesthetics Drainage
- Heritage Conservation Tree Protection

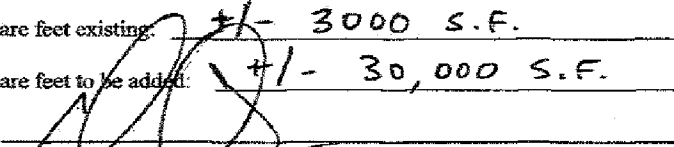
- 14. Total amount of building square feet existing: +/- 3000 S.F.
- 15. Total amount of building square feet to be added: +/- 30,000 S.F.
- 16. Signature of Applicant(s): 

PROPERTY OWNER, APPLICANT (OPTIONEE), AND AGENT WILL BE COPIED ON ALL CORRESPONDENCE FROM THE GROWTH MANAGEMENT DEPARTMENT.



**ADDITION CONCERNS REGARDING VIOLATIONS OF FLORIDA STATUTES,
FLORIDA BUILDING CODE, LIFE SAFETY CODE, FLORIDA PREVENTION CODE**

COT Site Plan Approval of 1864 West. COT, TSP110042 Site Plan File

There seems to be a pattern of three story student apartment housing projects being permitted as three bedroom residential units then leased and occupied by four independent tenants (www.1864west.com) as an apartment complex without any sprinkler system being installed. These units are being permitted and constructed without an Architect's or proper fire review oversight.

Someone could be seriously injured or killed due to the lack of this proper oversight.

1864 West in Tallahassee was cited by the Engineer of Record as justification for Campus Block development. *1864 West* appears to have been permitted as a three story, three bedroom and study hall residences without fire sprinklers permitted in 2011 TSP110042 as a three story three bedroom per unit and is apparently being leased and occupied as 11 four bedroom individual tenant apartments. The *1864 West* apartment complex should also be investigated for similar discrepancies in Florida Statute and Code applications.

TYPE "A" PERMIT SET FOR 1866 WEST

1866 BELLE VUE WAY
CITY OF TALLAHASSEE OF LEON COUNTY, FLORIDA

SUBMITTED FOR REVIEW: 9.20.2011



1866 WEST

PROJECT INFORMATION

DESIGNED BY: [REDACTED]
 DRAWN BY: [REDACTED]
 CHECKED BY: [REDACTED]
 DATE: [REDACTED]

CONTRACT NO.: [REDACTED]
 PROJECT NO.: [REDACTED]

CLIENT: [REDACTED]
 ADDRESS: [REDACTED]

DATE OF ISSUE: [REDACTED]

PROJECT LOCATION: [REDACTED]

PROJECT DESCRIPTION: [REDACTED]

PROJECT OWNER: [REDACTED]

PROJECT ENGINEER: [REDACTED]

PROJECT ARCHITECT: [REDACTED]

PROJECT CONTRACTOR: [REDACTED]

PROJECT INSURANCE: [REDACTED]

PROJECT BOND: [REDACTED]

PROJECT PERMIT: [REDACTED]

PROJECT APPROVAL: [REDACTED]

PROJECT REVIEW: [REDACTED]

PROJECT CLOSURE: [REDACTED]

PROJECT DATA

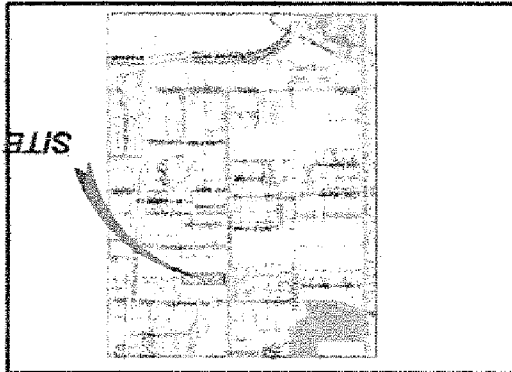

VICINITY MAP

NO.	SHEET TITLE:	REV. DATE
01	COVER SHEET	
02	EXISTING CONDITIONS	
03	DEMO PLANS	
04	SITE PLAN	
05	EROSION CONTROL PLAN	
06	DRAINAGE PLAN	
07	UTILITY PLAN	

SHEET INDEX

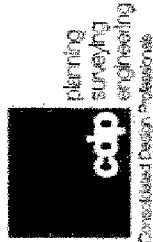

Civil Design Professionals
 200 S. W. 1st Street
 Tallahassee, FL 32301
 Phone: 904.833.8888
 Fax: 904.833.8884



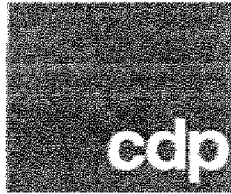

planning
surveying
engineering

June 23, 2011
Revised August 4, 2011

Ms. Cindy Smith, Senior Planner
Land Use and Environmental Services
300 S. Adams Street
3rd Floor
Tallahassee, FL

Re: 1864 Belle Vue Way Type A Submission

Ms. Smith:

The proposed re-development consists of (11) new 3 bedroom buildings located on 0.9 acres on Belle Vue Way. The project is consistent with the UT zoning and MMTD standards as we interpret them. There is the associated parking and detention as well as the landscape areas that are required for this project.

For this project our intent is to utilize a central dumpster for the project as well. I have included samples of the potential buildings from a project located just down the street. Our intent is to utilize the same architect and buildings for our site.

If you have any question, please do not hesitate to call at your convenience.
Sincerely,

A handwritten signature in black ink, appearing to read 'Tom Daniel', is written over a set of horizontal lines.

Tom Daniel, RLA
Project Manager

253 e. virginia st.
Suite B
tallahassee, fl 32301
850-703-5268

475 swanson road
suite C
tyronc, ga 30290
770-486-7370

Certificate Number: TCM110049
Date Issued: 11/15/2011
Expiration Date: 12/27/2011

CITY OF TALLAHASSEE
PRELIMINARY CERTIFICATE OF CONCURRENCY

Applicant: WEBB BRIAN
Owner: WEBB BRIAN
Project Name: 1864 WEST
Project Location: 1864 BELLE VUE WAY

PARCEL I.D. NUMBER(S):

21-34-51-000-1360
1864 BELLE VUE WAY T/LC

Type of Land Use:	Amount:	Sq. Ft./# of Units:
Residential-Condo/Townhome	11	DU

COMMENTS: 11 DU = 33 beds student housing

Your concurrency has been obligated through the expiration date shown above. This is to remind you that after that date, if your project has not been submitted for Site Plan review/approval, the project will be considered withdrawn. In order to reinstate the project, a new application and fees must be submitted.

This certificate is issued pursuant to City of Tallahassee Ordinance Number 90-0-0080AA. Based upon the information submitted by the applicant, this certificate certifies that a development with the land use densities and intensities specified at the location specified above will have adequate infrastructure capacity tentatively reserved for water, sewer, solid waste, stormwater, parks, transit and roads to serve the needs of the development. The information provided by the applicant has not been verified as accurate by staff. This permit in no way gives the proposed development any final authorization to develop, nor does it absolve the applicant from fulfilling the requirements of any Federal, State, County, or City Laws or regulations related to land use or land development.

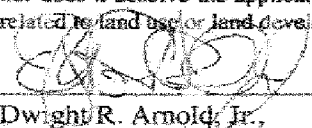

Dwight R. Arnold, Jr.,
Development Review Administrator

11/15/2011
Date

-
-
- The above project has received Final Development Approval and the Approved Site Plan/Plat is attached for your review.
 The above project has been modified from the original submittal.
 The above project has been denied Final Development Approval.

Land Use Administration/Growth Management

Date

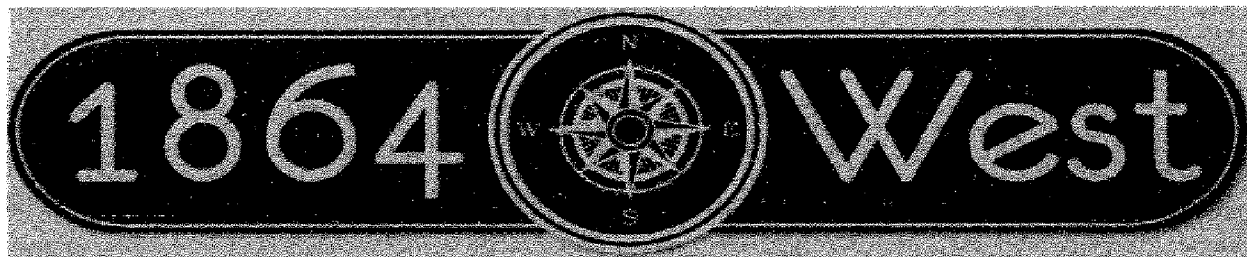

850-224-7368

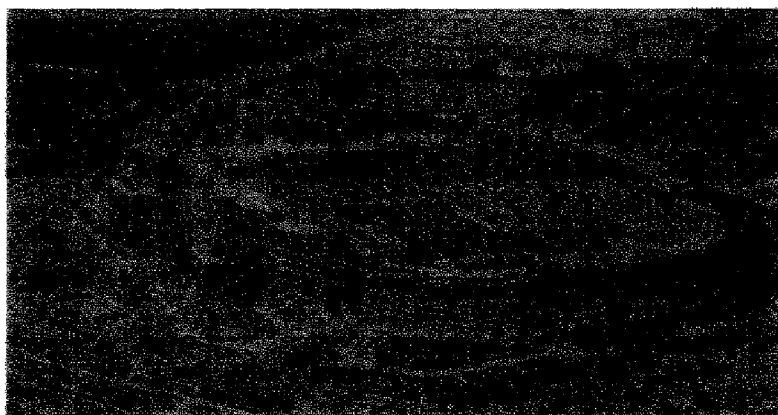

[Home](#)
[Location Map](#)

[Site Plan](#)
[Units 1-3 Elevation / Floorplan](#)
[Units 4-11 Elevation / Floorplan](#)

[Leasing Information](#)
[Availability](#)
[1864 West Photo Gallery](#)
[Contact Us](#)



Contact Us

Leasing:
850-224-7368
808 W. ST. AUGUSTINE
ST.
TALLAHASSEE, FL 32304
info@leparuloproperties.com

Developer:
Patrick Chisholm
PLC Partners, LLC
2460 Forest Club Dr.
Orlando, FL 32804
407-923-8366
pat@plcpartnersllc.com

1864 West, Tallahassee Student Housing, Tallahassee Rentals, Tallahassee
Condo Rental, Tallahassee FSU Housing



[Click for Larger View](#)

All 11 units and 44 bedrooms leased.
100% occupied.
Thanks FSU students for your support.

- 1864 West - a Student Townhome Community.
- A total of 11 four bedroom, 4-1/2 bath Townhomes.
- Walk to campus, only 4 blocks west of Doak Campbell Stadium located at 1864 Belle Vue Way.
- Large townhomes each with their own 2-car garage.
- Safety is paramount with plenty of dawn until dusk exterior lighting.
- Each townhome has its own 2-car garage with door opener and 2-car driveway.
- Alarm system in each unit.
- Large bedrooms each with its own walk-in closet and private bathroom.
- 9 foot ceilings, wood flooring, stainless steel appliances, granite countertops.
- Full size washer & dryer in each townhome.
- Each townhome is over 2,000 square feet of air conditioned space.
- Private front balcony and rear porch in each unit.
- Plenty of parking with small subdivision feel.
- Feel the excitement on football game day in the fall with the activity along Bellevue within blocks of Doak Campbell Stadium.

[Home of 1864 West](#)

[FSU Housing Location](#)

[FSU Rental Site Plan](#)

[Tallahassee Rentals Units 1-3](#)

[Tallahassee Rentals Units 4-11](#)

[College Rentals Leasing Information](#)

[1864 West Gallery](#)

[Contact 1864 West](#)

Powered by [The Dreamers Web](#)

1864 West

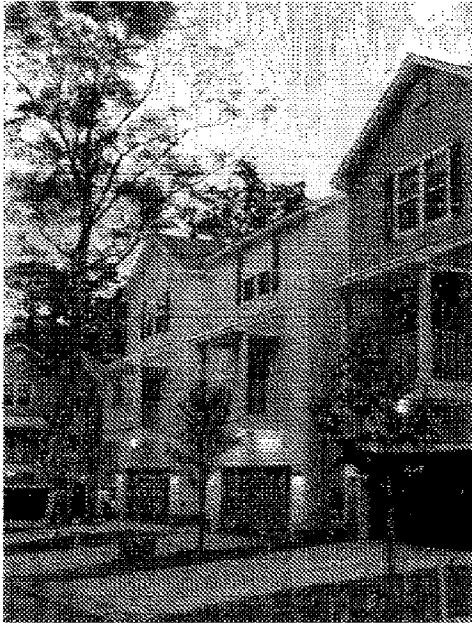

- **ZERO SECURITY DEPOSIT FOR ALL LEASES SIGNED IN FEB.**
- **4 BEDROOM / 4-1/2 BATH STUDENT TOWNHOMES, OVER 2,000 SF**
- **GRANITE COUNTER TOPS, STAINLESS APPLIANCES. WOOD FLOORS**
- **2 CAR GARAGES. 2 CAR DRIVEWAY, PARK NEXT TO FRONT DOOR, ALARM**
- **COMMON AREA FURNISHED (2 FULL SIZE SOFA'S, COFFEE AND END TABLE, 4 BAR STOOLS, DINING TABLE WITH 4 CHAIRS)**
- **BUILT IN 2012**
- **LEASING NOW FOR 2013/2014**
- **\$605 PER BED FURNISHED**
- **\$595 PER BED UN-FURNISHED**

Call Owner Pat Chisholm for more information 407-923-8366
www.1864west.com

 **LEPARULO**
PROPERTIES + INVESTMENTS
Give Us A Call: (850) 224-7368

FIRST FLOOR LEVEL

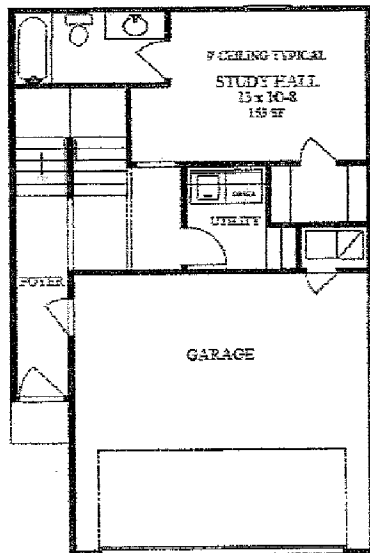

SECOND FLOOR LEVEL

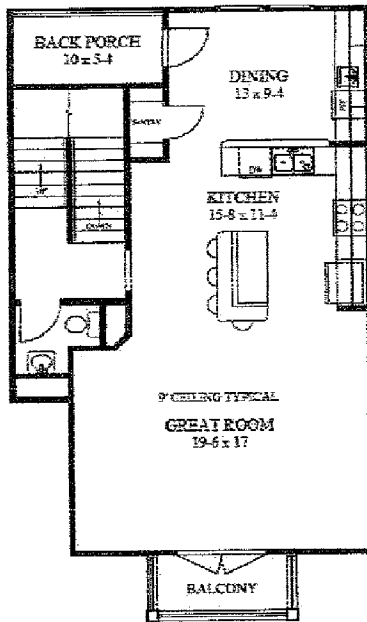

THIRD FLOOR LEVEL

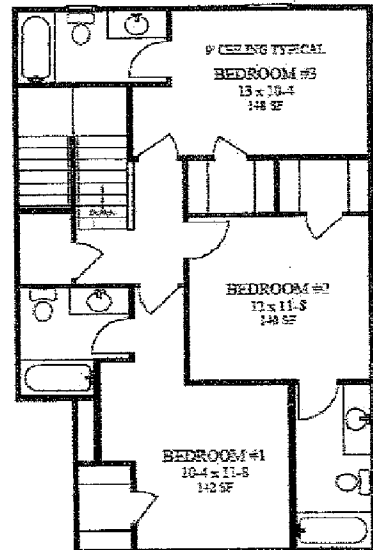

496 SF FIRST FLOOR LEVEL
841 SF SECOND FLOOR LEVEL
834 SF THIRD FLOOR LEVEL
2161 SF TOTAL CONDITIONED SPACE
400 SF GARAGE
56 SF BACK PORCH
47 SF BALCONY
12 SF FRONT PORCH

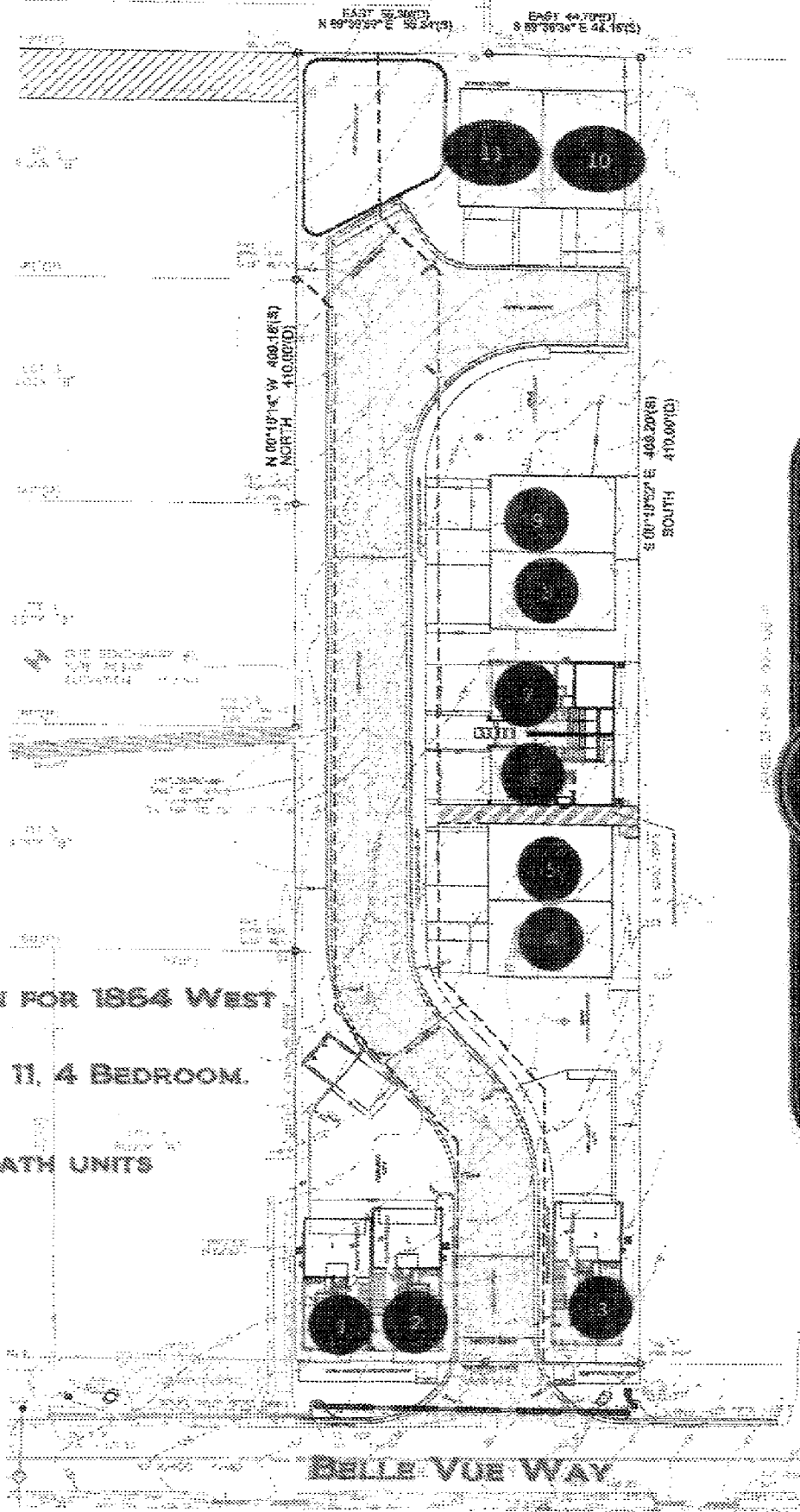

SITE PLAN FOR 1864 WEST

TOTAL OF 11, 4 BEDROOM.

4-1/2 BATH UNITS

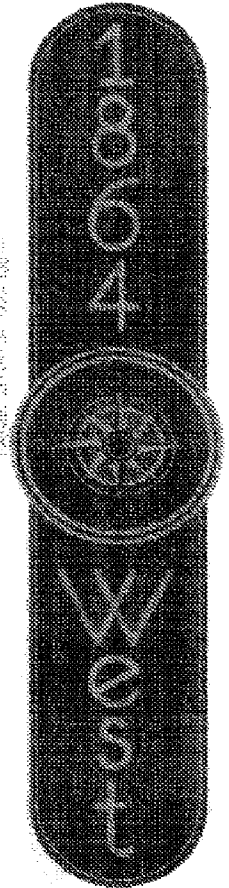

1864 West



850-224-7368
 NOW LEASING
 FOR
 AUGUST 2012

All 11 units leased.

We have a few bedrooms available for lease in select units.

4 BED/4.5 BATH TOWNHOMES

** Lease Special: \$595 per bedroom for brand new construction close to campus. Contact Leparulo Properties for details.

- A BLOCK WEST OF DONK CAMPUS
- 2 CAR GARAGE
- PRIVATE BALCONY & PORCH
- 9 FOOT CEILING
- PLENTY OF PARKING
- WALK TO SCHOOL
- LARGE UNITS OVER 2,000 SF
- 11 TOTAL UNITS, 44 BEDS
- SMALL SUBDIVISION FEE
- PLENTY OF EXTERIOR LIGHTING
- ALARM SYSTEMS
- WALK IN CLOSETS
- PET FRIENDLY

FIRST FLOOR LEVEL

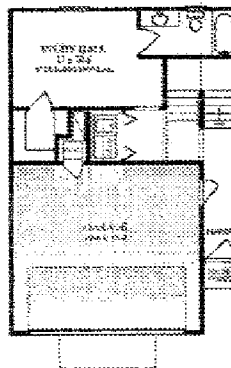

SECOND FLOOR LEVEL

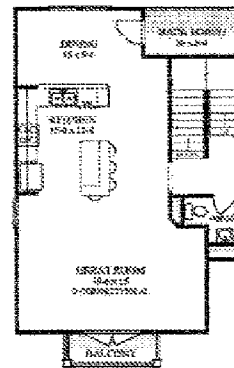

THIRD FLOOR LEVEL

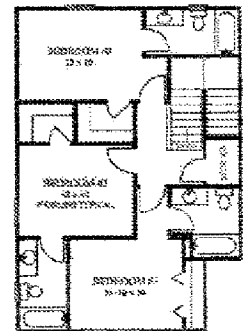

NOTE: PER PERMITS FROM
 TALLAHASSEE COUNTY, FLORIDA
 THIS UNIT IS A 3-BEDROOM UNIT.
 THE BALCONY IS 12'0" WIDE.
 THE BATH IS 5'0" WIDE.
 THE KITCHEN IS 10'0" WIDE.
 THE LIVING AREA IS 12'0" WIDE.



LEPARULO
 PROPERTIES • INVESTMENTS

808 W. ST. AUGUSTINE STREET
 TALLAHASSEE, FL 32304

850.224.7368

www.1864west.com

THE UNIVERSITY OF CHICAGO LIBRARY

100 EAST EAST

CHICAGO, ILLINOIS 60607

TEL: 773-936-3700

FAX: 773-936-3700

WWW.CHICAGO.LIBRARY.EDU

CHICAGO LIBRARY

CHICAGO LIBRARY

CHICAGO LIBRARY

CHICAGO LIBRARY

CHICAGO LIBRARY

CHICAGO LIBRARY

CHICAGO LIBRARY

CHICAGO LIBRARY

CHICAGO LIBRARY

CHICAGO LIBRARY

CHICAGO LIBRARY

CHICAGO LIBRARY

CHICAGO LIBRARY

CHICAGO LIBRARY

Next List



Officer/Registered Agent Name List

Officer/RA Name	Entity Name	Entity Number
<u>CHISHOLM, PATRICK</u>	NSCOPE LLC	L04000029919
<u>CHISHOLM, PATRICK</u>	PLC PARTNERS, LLC	L11000072887
<u>CHISHOLM, PATRICK</u>	PLC PARTNERS, LLC	L11000072887
<u>CHISHOLM, PATRICK</u>	CAMPUS BLOCK FSU, LLC	L12000131855
<u>CHISHOLM, PATRICK</u>	CAMPUS BLOCK FSU, LLC	L12000131855
<u>CHISHOLM, PATRICK</u>	P.W. CHISHOLM, INC.	P29564
<u>CHISHOLM, L. PATRICK</u>	THE 1864 AT BELLEVUE, LLC	L11000089284
<u>CHISHOLM, L. PATRICK</u>	THE 1864 AT BELLEVUE, LLC	L11000089284
<u>CHISHOLM, L. PATRICK</u>	1864 WEST CONDOMINIUM ASSOCIATION, INC.	N12000007470
<u>CHISHOLM, W. PATRICK</u>	ANAXAGORAS LLC	L10000126631
<u>CHISHOLM, W. PATRICK</u>	P.W. CHISHOLM, INC.	P29564

Detail by Officer/Registered Agent Name

Florida Non Profit Corporation 1864 WEST CONDOMINIUM ASSOCIATION, INC.

Filing Information

Document Number N12000007470 FEI/EIN Number NONE Date Filed 08/01/2012 State or Country FL Status ACTIVE

Principal Address

2460 FOREST CLUB DRIVE
ORLANDO, FL 32804

Mailing Address

2460 FOREST CLUB DRIVE
ORLANDO, FL 32804

Registered Agent Name & Address PADGETT, TIMOTHY DESQUIRE

TIMOTHY D. PADGETT, P.A.

2878 REMINGTON GREEN CIRCLE

TALLAHASSEE, FL 32308

Officer/Director Detail Name & Address

Title D/O

1/10/19

Today we went to the bank to get some money out of the account. I had to go to the bank to get some money out of the account. I had to go to the bank to get some money out of the account.

The bank was very busy today. I had to wait for a long time to get to the counter. I had to wait for a long time to get to the counter.

I had to wait for a long time to get to the counter. I had to wait for a long time to get to the counter. I had to wait for a long time to get to the counter.

I had to wait for a long time to get to the counter. I had to wait for a long time to get to the counter. I had to wait for a long time to get to the counter.

I had to wait for a long time to get to the counter. I had to wait for a long time to get to the counter. I had to wait for a long time to get to the counter.

Thank you

John

1/10/19



BUILDING INSPECTION

Mailing: 300 South Adams St., B-28
Tallahassee, Florida 32301



APPLICANT SERVICES
850-891-7125
FAX: 850-891-0948
BUILDING INSPECTION
850-891-7050
FAX: 850-891-7099

Location: 455 N Macomb St.
Tallahassee, FL 32301

Type A Site Plan- Meeting on 11/17/11

2) **1864 West** (TSP110042) (21-34-51-000-1360) located on 0.94-acre at 1864 Belle Vue Way. The proposed project is the construction of 11 multi-family, 3 bedroom dwelling units. The property is zoned R-5 (Manufactured Home and Single-Family Detached).

PROJECT COORDINATOR: South Team (891-7100) Gordon Hansen – Senior Planner
AGENT: Consolidated Design Professionals – 850-702-5268
TIME: 9:15 a.m.

Building Inspection Division Comments – Bob Tredik 891-7071 bob.tredik@talgov.com

- 1) It is unclear whether this project is being constructed under the residential code as condo style townhouse buildings or under the commercial bldg code as apt bldgs. Please verify.
- 2) Under the FBC-B, all residential buildings are required to be sprinklered.
- 3) If reviewed under the residential code, each condo parcel must be given an address
- 4) Please schedule a meeting with this reviewer to further discuss the permitting of this project.

1864 West (TSP110042) (21-34-51-000-1360) located on 0.94-acre at 1864 Belle Vue Way. The proposed project is the construction of 11 multi-family, 3 bedroom dwelling units. The property is zoned R-5 (Manufactured Home and Single-Family Detached).



Florida Division of State Fire Marshal

The Florida Fire Marshals and Inspectors Association,
"Organization" (§633.026)

Informal Interpretation

Date: July 17, 2012

NFPA Document Number: NFPA 101

Edition: 2009

Paragraph Reference: 30.3.5.1

For purpose of this petition, pertinent factors do not include the name of the governmental agency or persons representing that agency. Petitioners are discouraged from making any personal assertions about an agency or agency official. If this involves an actual situation, briefly explain all of the pertinent factors.

Actual Situation Explanation:

We have prepared plans for a six (6) unit town home project in Pasco County Florida. The building contains 14,620 square feet. The building is founded on a concrete foundation with a concrete slab on grade. The exterior walls and party walls are CMU. The party walls have a two (2) hour rating. The elevated floor system is designed using pre-engineered wooden floor trusses (system 42) and 3/4" plywood or OSB. In the living areas over the attached garage the floor system has a one (1) hour rating. [T]he roof system consists of pre-engineered wooden roof trusses covered with 7/16" OSB or plywood. For a distance of four feet (4') on each side of the party walls, FRT [sheeting] is used. We are being told that the building must be protected with an approved fire sprinkler system. We content that town homes are to be considered as single family buildings with zero (0) lot lines and therefore sprinklers are not required.

Question (should be worded so that it can be answered with either "Yes" or "No"):

In line with the situation [explained] above and in accordance with section 30.3.5.1 of the Florida Fire Protection Code, does this building, or others similarly designed need fire sprinkler protection?

Answer: No

Justification:

The underlying issue to this question is: Is the described structure an "apartment" or is the structure a "one-and two-family dwelling as defined by the Florida Fire Prevention Code?

If the structure is determined to be an "apartment," then it is regulated by Chapter 30 of the Life Safety Code and requires fire sprinkler protection. If the structure is determined to be a "one-and two-family

Rulings herein expressed are not the formal position of the Florida State Fire Marshal's Office

3108 S.E. 21st Court | Okeechobee, FL 34974-6331 | Phone: (863) 467-8991 | Fax: (863) 467-8991

Website: www.FFMIA.org | Email: info@ffmia.org | http://www.myfloridacfo.com/sfm/bfpr/bfpr_index.htm



Florida Division of State Fire Marshal

The Florida Fire Marshals and Inspectors Association,
"Organization" (§633.026)

dwelling," then it is regulated by Chapter 24 of NFPA 101 and does not require fire sprinkler protection.

NFPA 101 Section 3.3.32.3 defines an "Apartment Building" as: "A building or portion thereof containing three or more dwelling units with independent cooking and bathroom facilities." The annex explanatory text to this definition goes on to provide further guidance to the user by stating: "The Code specifies that, where ever there are three or more living units in the building, the building is considered an apartment building and is required to comply with either Chapter 30 or Chapter 31, as appropriate. *Townhouse units are considered to be apartment buildings if there are three or more units in the building. The type of wall required between units in order to consider them to be separate buildings is normally established by the authority having jurisdiction. If the units are separated by a wall of sufficient fire resistance and structural integrity to be considered as separate buildings, then the provisions of Chapter 24 apply to each townhouse. Condominium status is a form of ownership, not occupancy; for example, there are condominium warehouses, condominium apartments, and condominium offices.*" (*Emphasis Added*)

NFPA 101 Section 3.3.61.1 defines a "One-and Two-Family Dwelling Unit" as: "A building that contains not more than two dwelling units with independent cooking and bathroom facilities."

NFPA 101 6.1.8.1.5 reiterates the definition of a "apartment building" but adds commentary to the text at the end of section 6.1.8.1.5. This commentary states in part "The definition of *apartment building* in 6.1.8.1.5 is copied from A.3.3.32.3. The text of A.3.3.32.3 clarifies that townhouse-type apartments - particularly those under condominium ownership - are to be classified as apartment buildings. It is often mistakenly believed that condominiums are a form of occupancy rather than a form of ownership."

The structure in question is not described as a condominium form of ownership. Therefore, based on these two definitions, if the "Townhouse" units are separated by a wall of sufficient fire resistance and structural integrity, then they can be considered separate buildings and regulated as one-and two-family dwellings under Chapter 24 of NFPA 101.

The key to both of these definitions is what rating and integrity of the separation wall is required to create separate buildings? NFPA 101 does not provide specific guidance on the rating or integrity of this wall. However, Section 1.1.16 "Areas Not Addressed" provides the user with some guidance as to why this issue is not addressed in NFPA 101 and where to look for guidance in answering this question.

Section 1.1.16 "Areas Not Addressed" states, in part:

"The *Code* does not address the following:

Rulings herein expressed are not the formal position of the Florida State Fire Marshal's Office

3108 S.E. 21st Court | Okeechobee, FL 34974-6331 | Phone: (863) 467-8991 | Fax: (863) 467-8991

Website: www.FFMA.org | Email: info@ffma.org | http://www.myfloridafco.com/sfm/ffma/ffma_index.htm



Florida Division of State Fire Marshal

The Florida Fire Marshals and Inspectors Association,
"Organization" (§633.026)

- (1) General fire prevention or building construction features that are normally a function of the fire prevention and building codes."

The annex text to A.1.1.6(1) states as an explanation to the above sub (1): "The *Code* is intended to be adopted and used as part of a comprehensive program of building regulations that include building, mechanical, plumbing, electrical, fuel gas, fire prevention, and land use regulations."

The handbook commentary provided explanation to this text with the following:

"The *Code* is not intended to be either a building code or a fire prevention code." "The code intentionally excludes traditional building code topics such as wind loads, seismic consideration, and exterior exposure protection."

Therefore, it is reasonable to assume, by the NFPA 101 Life Safety Code not specifying a minimum rating and integrity of the wall needed to separate townhomes, that the code intended these requirements to be specified in a "traditional building code" adopted by the Authority Having Jurisdiction.

It is important to note that the "Authority Having Jurisdiction"(AHJ) can be an "organization, office, or individual responsible for enforcing the requirements of a code or standard, or for approving equipment, materials, an installation, or a procedure." (NFPA 101 3.2.2.) For the purposes of adopting a Building Code in the State of Florida and specifying the minimum type of separation between Townhouses to create separate buildings, in lieu of a specific requirement contained in NFPA 101, the AHJ is the Florida Building Commission under 553.77.

The Florida Building Commission has adopted the 2009 International Residential Code, with Florida specific amendments, to become the Florida Building Code-Residential. Section R302.2 contains specific separation requirements for the construction of a fire resistant structurally independent wall between two "Townhouse" units.

Section "R302.2 Townhouses" states in part:

"Each townhouse shall be considered a separate building and shall be separated by fire resistance rated wall assemblies meeting the requirements of R302.1 for exterior walls.

Exception: A common 2-hour fire-resistance-rated wall assembly tested in accordance with ASTM E 119 or UL 263 is permitted for townhouses if such walls do not contain plumbing or mechanical equipment. . ."

Section "R302.2.4 Structural independence" states in part:

Rulings herein expressed are not the formal position of the Florida State Fire Marshal's Office

3108 S.E. 21st Court | Okeechobee, FL 34974-6331 | Phone: (863) 467-8991 | Fax: (863) 467-8991

Website: www.FFMIA.org | Email: info@ffmia.org | http://www.myfloridacfo.com/sfm/bfpr/bfpr_index.htm

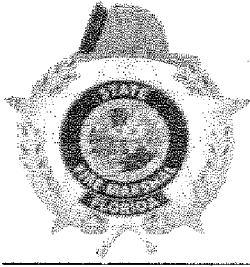

Florida Division of State Fire Marshal

The Florida Fire Marshals and Inspectors Association,
"Organization" (§633.026)

Each individual townhouse shall be structurally independent. . ."

Although the Florida Fire Prevention Code and the Florida Building Code are adopted under separate statutory authority by the State Fire Marshals Office and the Florida Building Commission, it was clearly the legislative intent that the two documents work together in regulating construction. There are numerous references contained in FS 553 and FS 633 directing the Building Commission and the State Fire Marshals Office to coordinate their adoptions and consider the actions of the other body in adopting the code. Specifically, the Florida Building Commission was directed to "coordinate efforts to provide consistency between the Florida Building Code and the Florida Fire Prevention Code and the Life Safety Code." FS 553.779(1)(e). The State Fire Marshals Office is directed in FS 633.025(1) to have the "The Florida Fire Prevention Code and the Life Safety Code adopted by the State Fire Marshal, which shall operate in conjunction with the Florida Building Code. . ."

In considering how the code should be applied in dealing with the design of the fire separation wall separating two townhouse buildings, there is no conflict between the Florida Fire Prevention Code and the Florida Building Code. The codes are simply functioning as intended by the legislature and the NFPA 101 Technical Committee. Where the guidance provided in NFPA 101 ends, the guidance provided by the Florida Building Code picks up to provide very specific clarity as to the design and structural requirements of a wall required to consider townhomes as separate buildings. The design described by the requestor appears to be consistent with the design specified in the Florida Building Code for the townhouses to be considered as separate buildings and, therefore, not regulated by Chapter 30 of NFPA 101.¹

¹ The Interpretation Committee believes it is important to note that:

1. The provisions of the Florida Building Code-Residential, regarding the design of townhouse separation walls, are consistent with the provision of NFPA 5000 Building Code for townhouse separation.
2. The provisions of NFPA 101 section 8.2.1.3 infers that a 2-hour wall is appropriate to consider two different types of construction as two separate buildings.
3. NFPA 13D, 2010 edition now states in the handbook commentary that "One of the frequently asked questions regarding NFPA 13D is whether or not the document is appropriate to use for multiple townhouses. . ." "The answer depends on how the townhouses are designed. If the townhouses are constructed in accordance with the International Residential Code, then the use NFPA 13D is appropriate." NFPA 13D is the Standard for the Installation of Sprinkler Systems in One-and Two-Family Dwellings and Manufactured Homes.

The references above are consistent with the interpretation decision issued by this committee.

Rulings herein expressed are not the formal position of the Florida State Fire Marshal's Office

3108 S.E. 21st Court | Okeechobee, FL 34974-6331 | Phone: (863) 467-8991 | Fax: (863) 467-8991

Website: www.FFMA.org | Email: info@ffmia.org | http://www.myfloridacfo.com/sfm/bfor/bfor_index.htm



Florida Division of State Fire Marshal

The Florida Fire Marshals and Inspectors Association,
"Organization" (§633.026)

Committee Answer Submitted by,

Bart Wright, Chair
Informal Fire Code Interpretation Committee

Rulings herein expressed are not the formal position of the Florida State Fire Marshal's Office

3108 S.E. 21st Court | Okeechobee, FL 34974-6331 | Phone: (863) 467-8991 | Fax: (863) 467-8991

Website: www.FFMA.org | Email: info@ffmia.org | http://www.myfloridacfo.com/sfrn/bfpr/bfpr_index.htm

SMITH THOMPSON
SHAW MINACCI & COLÓN, P.A.
ATTORNEYS AT LAW

W. CRIT SMITH
SUSAN S. THOMPSON*
FRANK S. SHAW, III
DAVID K. MINACCI*
MARY W. COLÓN*
SHAWN P. GOLETZ
ANDREW J. POWER

June 5, 2013

*ALSO ADMITTED IN GEORGIA

Jeff Atwater
Florida State Fire Marshall and Chief Financial Officer
200 East Gaines Street
Tallahassee, FL 32399-0341

Re: Complaint Related to Fire Safety Issues at Campus Block FSU Project

Dear Mr. Atwater:

The Board of Architecture and Interior Design (Board) has contracted with the law firm of Smith, Thompson, Shaw, Minacci & Colón, P.A. to provide investigative and prosecutorial services. Enclosed please find a copy of documentation that was recently provided to us as a consumer complaint. After review by the Board's architectural consultant, Jerry L. Hicks, and discussion with the Board's prosecutor, David Minacci, it has been determined that due to the City of Tallahassee's classification of the project as residential townhomes (rather than apartments) and since townhomes do not require the involvement of a licensed architect for project design, the Board has no jurisdiction over this project or the parties involved.

We still have concerns that the actual use of the property as student apartment housing rather than townhomes presents multiple life safety issues that have not been addressed and the construction for which has not been included in the project. The documents included in the complaint clearly show that permitting of the project as townhomes is not consistent with the photographs and documentation related to the proposed use. These 10 units each have 4 bedrooms that will be leased to individual students resulting in there being 40 individual students living in these units with insufficient fire protection. Since these units are designated as residential townhomes, they are not required to have an automatic fire sprinkler system. Also, had this project been properly designated as apartments, a licensed architect would have been required for the production of the project design, which would have required the inclusion of life safety features such as sprinkler systems, comprehensive parking design, and all the necessary and required fire safety components.

It should be noted that both the City of Tallahassee and the engineer refer to this project as student apartments although the City chose to permit these units as townhomes. They are also being constructed on one common parcel of land.

We respectfully request your review of these documents and the project site to determine what measures are needed in order to implement the needed life safety plan which would be consistent with this type of development.

Sincerely,



Mary Helena (M.H.) Allen
Investigator, Board of Architecture & Interior Design
Enclosures

