

**EVALUATION OF FIRE SEPARATION CHANGES FROM 2012 IRC TO 2015
AND RECOMMENDATIONS FOR A COST EFFECTIVE
METHOD OF ALTERNATIVE CONSTRUCTION**

RINKER-CR-2015-102

Draft Final Report

26 May 2016

Submitted to

Mo Madani

Department of Business and Professional Development
1940 North Monroe Street
Tallahassee, FL 32399

Authors

R. Raymond Issa, Ph.D., J.D., PE, API
Mark Aaby, P.E. and Kristin Kristin Steranka (Koffel Associates)

Copyright ©2015 Center for Advanced Construction Information Modeling/University of Florida
All Rights Reserved.

CACIM
Rinker School
University of Florida
Box 115703
Gainesville, FL 32611-5703
www.bcn.ufl.edu/cacim



DISCLAIMER

The Center for Advanced Construction Information Modeling/University of Florida nor any agency thereof, nor any of their employees, makes any warranty, express or implied, or assumes any legal liability or responsibility for the accuracy, completeness, or usefulness of any information, apparatus, product, or process disclosed, or represents that its use would not infringe privately owned rights. Reference herein to any specific commercial product, process, or service by trade name, trademark, manufacturer, or otherwise does not necessarily constitute or imply its endorsement, recommendation, or favoring by the Center for Advanced Construction Information Modeling/University of Florida or any agency thereof. The views and opinions of authors expressed herein do not necessarily state or reflect those of the Center for Advanced Construction Information Modeling/University of Florida or any agency thereof.

TABLE OF CONTENTS

	PAGE
1. EXECUTIVE SUMMARY	2
2. PROJECT SCOPE	2
3. CODE REFERENCES.....	3
4. LITERATURE REVIEW	3
4.1 2015 Code Requirements	3
4.2 Code History.....	5
4.3 Prescriptive Assemblies.....	7
4.4 Performance Based Assemblies	12
4.5 Cost Effective Alternatives.....	13
5. CONCLUSION.....	15
APPENDICES	
A – County of San Diego Eave Construction Details.....	A1
B – Engineering Judgement Details.....	B1
C – Fire Pillow Data Sheet.....	C1

EVALUATION OF INTERNATIONAL RESIDENTIAL CODE CHANGES FOR FLORIDA BUILDING COMMISSION AND THE UNIVERSITY OF FLORIDA

1. EXECUTIVE SUMMARY

The University of Florida has contracted Koffel Associates, Inc., on behalf of the Florida Building Commission, to evaluate the fire separation requirement changes from the 2012 Edition of the International Residential Code (IRC) as amended by Florida under the 5th Edition, 2014 Florida Building Code and the 2015 Edition of the IRC. This evaluation will focus on the applicable code requirements, and alternative methods of protection.

This version of the report is for submission on May 23 2016.

2. PROJECT SCOPE

The scope of this project is to evaluate the requirements for fire separations in the ‘Florida Building Code: Residential,’ 5th Edition and the changes to them in the 2015 IRC. There is a concern that these requirements have become more stringent, especially in relation to exterior walls and projections.

Fire separation distance is defined by the 2015 IRC as: “The distance measured from the building face to one of the following:

1. To the closest interior *lot line*.
2. To the centerline of a street, an alley or public way.
3. To an imaginary line between two buildings on the *lot*.

The distance shall be measured at a right angle from the face of the wall.”

Based on the fire separation distance, a building’s exterior walls, projections and openings have fire-resistance requirements. The primary focus of this evaluation will be on exterior wall and projection requirements for single family homes and townhouses, i.e. an attached single family dwelling with a zero lot line.

The evaluation will consist of a literary review of four (4) concepts related to fire-rated construction and fire separation distances. These concepts include a review of 2015 code requirement changes, code history, prescriptive and performance based approaches, and cost effective alternative construction.

The scope was limited strictly to reviewing the fire separation provisions of the codes. However, other code requirements will be discussed, as necessary, such as sprinkler protection, opening protection, and penetration protection.

3. CODE REFERENCES

The following codes and standards are used for this analysis:

- International Residential Code (IRC), 2015 Edition
- Florida Building Code Residential (FBC-R), 5th Edition (2014)

The primary reference of this evaluation will be the IRC, 2015 Edition, as Florida will use this code as the basis for the next edition of their residential building code. Note that the IRC and FBC-R are very similar. Any differences between the codes related to the code requirements addressed herein will be noted.

All terminology used in this report will be as defined by the IRC. For example, draftstopping can also be referred to as “draft stop,” “fire block,” or “fire stop.” These other terms may be common in the field, but the code has different definitions for this terminology. In addition, this terminology has changed over time and is present in the legacy codes.

4. LITERATURE REVIEW

The literature review includes an analysis of the 2015 code requirement changes, code history, prescriptive and performance based approaches, and cost effective alternative construction. Each item is discussed in the sections below.

4.1 2015 Code Requirements

The current code requirements for exterior walls and fire separation distance are in IRC Section R302.1. Fire separation distance is used to determine the fire-resistance needed for exterior walls, projections and openings. Per §R302.1, “Construction, projections, openings, and penetrations of exterior walls of dwellings and accessory buildings shall comply with Table R302.1 (1); or dwellings equipped throughout with an automatic sprinkler system installed in accordance with Section P2904 shall comply with Table R302.1 (2).”

Exceptions:

1. Walls, projections and openings or penetrations in walls perpendicular to the line used to determine the *fire separation distance*.
2. Walls of dwellings and accessory structures located on the same lot.
3. Detached tool sheds and storage sheds, playhouses, and similar structures exempted from permits are not required to provide wall protection based on location on the *lot*. Projections beyond the *exterior wall* shall not extend over the *lot line*.
4. Detached garages accessory to a dwelling located within 2 ft of a *lot line* are permitted to have roof eave projections not exceeding 4 in.
5. Foundation vents installed in compliance with the codes are permitted.”

Table R302.1 (1) EXTERIOR WALLS

EXTERIOR WALL ELEMENT		MINIMUM FIRE-RESISTANCE RATING	MINIMUM FIRE SEPARATION DISTANCE (feet)
Walls	Fire-resistance Rated	1-hr tested in accordance with ASTM E 119 or UL 263 with exposure from the outside.	< 5
	Not Fire-resistance Rated	0 hrs	≥ 5
Projections	Not Allowed	N/A	< 2
	Fire-resistance Rated	1-hr on the underside ^{a, b}	≥ 2 to < 5
	Not Fire-resistance Rated	0 hrs	≥ 5
Openings in Walls	Not Allowed	N/A	< 3
	25% Maximum of Wall Area	0 hrs	3
	Unlimited	0 hrs	5
Penetrations	All	Comply with Section R302.4	< 3
		None	3

- a. Roof eave fire-resistance rating shall be permitted to be reduced to 0 hrs on the underside of the eave if fire blocking is provided from the wall top plate to the underside of the roof sheathing.
- b. Roof eave fire-resistance rating shall be permitted to be reduced to 0 hrs on the underside of the eave provided that gable vent openings are not installed.

Table R302.1 (2) EXTERIOR WALLS- DWELLINGS WITH FIRE SPRINKLERS

EXTERIOR WALL ELEMENT		MINIMUM FIRE-RESISTANCE RATING	MINIMUM FIRE SEPARATION DISTANCE (feet)
Walls	Fire-resistance Rated	1-hr tested in accordance with ASTM E 119 or UL 263 with exposure from the outside.	0
	Not Fire-resistance Rated	0 hrs	3 ^a
Projections	Not Allowed	N/A	< 2
	Fire-resistance Rated	1-hr on the underside ^{b, c}	2 ^a
	Not Fire-resistance Rated	0 hrs	3
Openings in walls	Not Allowed	N/A	< 3
	25% Maximum of Wall Area	0 hrs	3 ^a
	Unlimited	0 hrs	5
Penetrations	All	Comply with Section R302.4	< 3
		None	3 ^a

- a. For residential subdivisions where all dwellings are equipped throughout with an automatic sprinkler system installed in accordance with Section P2904, the fire separation distance for nonrated exterior walls and rated projections shall be permitted to be reduced to 0 ft, and unlimited unprotected openings and penetrations shall be permitted, where the adjoining lot provides an open setback yard that is 6 ft or more in width on the opposite side of the property line.
- b. Roof eave fire-resistance rating shall be permitted to be reduced to 0 hrs on the underside of the eave if fire blocking is provided from the wall top plate to the underside of the roof sheathing.
- c. Roof eave fire-resistance rating shall be permitted to be reduced to 0 hrs on the underside of the eave provided that gable vent openings are not installed.

The code that is highlighted in yellow are the changes made from the 2012 to the 2015 Edition of the IRC. This language was added to address the construction problem of providing fire-resistive eave projections in addition to adequate roof ventilation vents. The 2015 IRC Revision History comments explain that the new language provides builders with an option to “mitigate this situation by providing for the installation of a top-side roof vent in lieu of fire-resistance treatments of the eave projection” [1].

Though fire blocking is normally only appropriate for approximately 10-15 minutes of fire-resistance, by providing this alternative the building code addresses the larger issue of roof ventilation. Roof ventilation is usually provided using “bird block” vents under roof eaves, which provide a direct path for fire, fire embers, and smoke to enter a non-sprinkler protected attic. An alternative ventilation option is providing a dormer vent which can be located on top of the roof and placed so that it does not negatively affect the aesthetics of the building. By changing the location of the vent and adding fire blocking under the projection, the attic space is effectively protected and the projection is simply considered expendable with no required rating. This allowance provides equivalent protection to the previous requirements for 1-hr fire-rated underside construction.

4.2 Code History

The requirement for 1-hr underside rating for projections dates back to before there was the International Code Council (ICC), when there were three (3) model code organizations: SBCCI, BOCA, and ICBO. These three building councils jointly sponsored the CABO One and Two Family Dwelling Code. This code was one of the first steps in creating uniformity between the code councils to eliminate conflict and repetition. The CABO One and Two Family Dwelling Code began to be referenced by the Uniform Building Code (UBC) in 1982. Exterior wall projection requirements were added to the CABO code in 1995. The following timeline table shows the transformation of the One and Two Family Building Code and its requirements for projections and exterior walls based on fire separation.

The Florida Building Code did not incorporate a separate Residential Code until 2004. In 2004, the Florida Building Code began to adopt and amend the International Residential Code. One of the biggest amendments made throughout the history of the FBC-R is the exception for zero lot line building projections. This exception, which changes numbers throughout the years as noted in the table below, allowed buildings with zero lot line’s to neglect the projection underside protection requirement as long as 6 ft was provided between the projection and any other projection or exterior wall. This exception has been removed in the 2014 FBC-R and the only way to be code compliant is to provide 1-hr fire-resistant construction on the underside of the projections for a zero lot line building.

Table 1. History of the Projection Code.

Code and Edition	Florida Building Code Adoption	Section	Requirement (IRC, FBC-R)
<i>CABO 1992</i>	Not Adopted	§R-202.1	<i>Required exterior walls less than 3 ft from the property line to have a 1-hr fire-resistance rating. Projections are not mentioned.</i>
<i>CABO 1995</i>	Not Adopted	§R-302.1	<i>Required exterior walls less than 3 ft from the property line to have a 1-hr fire-resistance rating. Projections were forbidden from extending more than 12 in. into areas where openings were prohibited.</i>
<i>International One- and Two – Family Dwelling Code 1998</i>	Not Adopted	§302.1	<i>Same requirements as CABO 1995.</i>
<i>IRC 2000</i>	Not Adopted	§R302.1	<i>Required exterior walls less than 3 ft from the property line to have a 1-hr fire-resistance rating. Projections could not extend more than 1/3 the distance to the property line from where protected openings were required or more than 12 in. into areas where opening were prohibited, whichever was smaller. If they extended past that smaller measurement, a 1-hr fire-resistance rating was required on the underside.</i>
<i>IRC 2003</i>	FBC-R 2004 §R302.1	§R302.1	<i>Required exterior walls less than 3 ft from the property line to have a 1-hr fire-resistance rating. Projections could not extend to be closer than 2 ft from the lot line. All projections that extend into the fire separation distance required a 1-hr fire-resistance rating on the underside. Exterior walls required 1-hr fire resistive construction on both sides if separated by less than 6 ft. Projections could not extend closer than 4 ft from an adjacent wall or projection. A projection extending into the 6 ft fire separation distance required a 1-hr fire resistive construction on the underside.</i>
<i>IRC 2006</i>	FBC-R 2007 §R302.1	§R302.1	<i>Single table used to classify the fire resistance rating required based on the fire separation distance for exterior walls, projections, openings, and penetrations. Projections were still forbidden from extending more than 12 in. into areas where openings were prohibited. Exception 4 allows that projections could not</i>

			extend closer than 4 ft from an adjacent wall or projection for zero lot line buildings. A 1-hr fire resistive construction was required on the underside of the projection if it was not separated by 4 ft from other projections.
<i>IRC 2009</i>	FBC-R 2010 §R302.1	§R302.1	<i>Same requirements as IRC 2006.</i> Same code requirement as FBC-R 2007, but was moved to be Exception 6.
<i>IRC 2012</i>	FBC 2014 §R302.1	§R302.1	<i>Two tables used to classify the fire resistance rating required, based on the fire separation distance and provided suppression, for exterior walls, projections, openings, and penetration.</i> <i>12-in. projection provision was removed.</i> Same code requirements as the IRC. Exception is removed that used to provide for zero lot line building projections. To allow for unprotected projections in a zero lot line building, the entire subdivision must be fully sprinkler protected and the adjoining yard must have a 6 ft setback to make use of Note a. in Table R302.1(2).
<i>IRC 2015</i>	Not Adopted	§R302.1	<i>See Section 4.1 of this report.</i>

Adjustments for sprinkler protected buildings begin in the 2004 Edition of the FBC. Specifically, §R317, which allowed ½-hr fire-resistance rating, instead of a 1 hr, between dwelling units in two family dwellings when equipped throughout with an automatic sprinkler system in accordance with NFPA 13. This provision is carried through the 2007, 2010 and 2014 Editions of the FBC. Allowances for exterior wall separation and projections in sprinkler protected buildings are not incorporated until the 2014 Edition of the FBC. Prior to the 2014 FBC, the allowances that were meant for fully sprinkler protected subdivisions were being used for non-sprinklered subdivisions through the Exceptions.

To minimize the misuse of the sprinkler allowances, two tables are presented; Table R302.1(1) Exterior Walls gives requirements for non-sprinkler protected buildings and Table R302.1(2) Exterior Walls-Dwellings with Fire Sprinklers gives requirements for buildings equipped throughout with a NFPA 13D sprinkler system installed in accordance with Section P2904.

4.3 Prescriptive Assemblies

Prescriptive assemblies are those that are generic and do not require certain brands of products. Section 721 of the International Building Code (IBC), provides multiple tables where one can choose the type of structural member to be protected, the type of insulating material to be used, and it will provide how thick the insulating material must be to provide 1, 2, 3, or 4 hrs of fire-resistance. Table 2 is a collection of all the permitted 1-hr construction types given in Section 721 of the IBC.

Table 2: 1-hr Fire-Resistance Rated Construction

Roof Construction	Ceiling Construction	Thickness of floor slab (-es)	Minimum Thickness of ceiling (inches)
Siliceous Aggregate Concrete	Slab (no ceiling required) minimum cover over nonprestressed reinforcement shall not be less than 3/4".	3.5	N/A
Carbonate Aggregate Concrete	Slab (no ceiling required) minimum cover over nonprestressed reinforcement shall not be less than 3/4".	3.2	N/A
Sand-Lightweight Concrete	Slab (no ceiling required) minimum cover over nonprestressed reinforcement shall not be less than 3/4".	2.7	N/A
Lightweight Concrete	Slab (no ceiling required) minimum cover over nonprestressed reinforcement shall not be less than 3/4".	2.5	N/A
Steel joists constructed with a poured reinforced concrete slab on metal lath forms or steel form units	Gypsum plaster on metal lath attached to the bottom cord with single No. 16 gauge or doubled No. 18 gauge wire ties spaced 6" on center.	2 1/4	5/8
Steel joists constructed with a poured reinforced concrete slab on metal lath forms or steel form units	Cement plaster over metal lath attached to the bottom chord of joists with single No. 16 gauge or doubled .049" (No.18 B.W. gauge) wire ties 6" on center. Plaster mixed 1:2 for scratch coat and 1:3 for brown coat for 1-hr system.	2	5/8
Reinforced concrete slabs and joists with hollow clay tile fillers laid end to end in rows 2 1/2" or more apart; reinforcement placed between rows and concrete cast around and over tile	None	5 1/2	N/A
1 1/2" deep steel roof deck on steel framing. Insulation board, 30 pcf density, composed of wood fibers with cement binders of thickness shown bonded to deck with unified asphalt adhesive. Covered with a Class A or B roof covering.	Ceiling of gypsum plaster on metal lath. Lath attached to 3/4" furring channels with .049" (No. 18 B.W. gauge) wire ties spaced 6" on center. 3/4" channel saddle tied to 2" channels with doubled .065" (No. 16 B. W. gauge) wire ties. 2" channels spaced 36" on center suspended 2" below steel framing and saddle tied with .165" (No. 8 B.W. gauge) wire. Plaster mixed 1:2 by weight, gypsum-to-sand aggregate.	1	3/4

<p>1 1/2" deep steel roof deck on steel framing wood fiber insulation board, 17.5 pcf density on top applied over a 15-lb asphalt-saturated felt. Class A or B roof covering</p>	<p>Ceiling of gypsum plaster on metal lath. Lath attached to 3/4" furring channels with .049" (No. 18 B.W. gauge) wire ties spaced 6" on center. 3/4" channel saddle tied to 2" channels with doubled .065" (No. 16 B. W. gauge) wire ties. 2" channels spaced 36" on center suspended 2" below steel framing and saddle tied with .165" (No. 8 B.W. gauge) wire. Plaster mixed 1:2 for scratch coat and 1:3 for brown coat, by weight for 1-hr system.</p>	<p>1</p>	<p>3/4</p>
<p>Vermiculite concrete slab proportioned 1:4 (Portland cement to vermiculite aggregate) on a 1 1/2" deep steel deck supported on individually protected steel framing. Maximum span of deck 6'-10" where deck is less than .019" (No. 26 carbon steel sheet gauge) or greater. Slab reinforced with 4" x 8" .109/.083" (No. 12/14 B.W. gauge) welded wire mesh.</p>	<p>None</p>	<p>3</p>	
<p>Perlite concrete slab proportioned 1:6 (Portland cement roperlite aggregate) on a 1 1/4" deep steel deck supported on indivudally protected steel framing. Slab reinforced with 4" x 8" .109/.083" (No. 12/14 B.W. gauge) welded wire mesh.</p>	<p>None</p>	<p>3 1/2</p>	
<p>Wood joists, wood I-joists, floor trusses and flat or pitched roof trusses spaced a maximum 24" o.c. with 1/2" wood structural panels with exterior glue applied at right angles to top of joist or top chord of trusses with 8d nails. The wood structural panel thickness shall not be less than nominal 1/2" nor less than required by Chapter 23.</p>	<p>Base layer 5/8" Type X gypsum wallboard applied at right angles to joist or truss 24: o.c. with 1 1/4" Type S or Type W drywall screws 24" o.c. Face Layer 5/8" Type X gypsum wallboard or veneer base applied at right angles to joist or truss through base layer with 1 7/8" Type S or Type W drywall screws 12" o.c. at joints and intermediate joist or truss. Face layer Type G drywall screws placed 2" back on either side of face layer end joints, 12" o.c.</p>	<p>Varies</p>	<p>1 1/4</p>

<p>Steel joists, floor trusses and flat or pitched roof trusses spaced a maximum 24" o.c. with 1/2" wood structural panels with exterior glue applied at right angles to top of joist or top chord of trusses with No. 8 screws. The wood structural panel thickness shall not be less than nominal 1/2" nor less than required by Chapter 23.</p>	<p>Base layer 5/8" Type X gypsumboard applied at right angles to steel framing 24" on center with 1" Type S drywall screws spaced 24" on center. Face Layer 5/8" Type X gypsum board applied at right angles to steel framing attached through base layer with 1 5/8" Type S drywall screws 12" on center at end joints and intermediate joints and 1 1/2" Type G drywall screws 12 in. on center placed 2" back on either side of face layer end joints. Joints of the face layer are offset 24" from the joints of the base layer.</p>	<p>Varies</p>	<p>1 1/4</p>
<p>Wood I-joist (minimum joist depth 9 1/4" with a minimum flange depth of 1 5/16" and a minimum cross-sectional area of 2.3 sq in. at 24" o.c. spacing with 1" by 4" (nominal) wood furring strip spacer applied parallel to and covering the bottom of the bottom flange of each member, tacked in place. 2" mineral wool insulation, 3.5 pcf (nominal) installed adjacent to the bottom flange of the I-joist and supported by the 1"x 4" furring strip spacer.</p>	<p>1/2" deep single leg resilient channel 16" on center (channels doubled at wallboard end joints), placed perpendicular to the furring strip and joist and attached to each joist by 1 7/8" Type S drywall screws. 5/8" Type C gypsum wallboard applied perpendicular to the channel with end joints staggered at least 4' and fastened with 1 1/8" Type S drywall screws spaced 7" on center. Wallboard joints to be taped and covered with joint compound.</p>	<p>Varies</p>	<p>5/8</p>
<p>Wood I-joists (minimum I-joist depth 9 1/4" with a minimum flange depth of 1 1/2" and a minimum flange cross sectional area of 5.25 sq in.; minimum web thickness of 3/8") @ 24" o.c., 1 1/2" mineral wool insulation (2.5 pcf nominal) resting on hat-shaped furring channels.</p>	<p>Minimum .026" thick hat shaped channel 16" o.c. (channels doubled at wallboard end joints), placed perpendicular to the joist and attached to each joist by 1 5/8" Type S drywall screws. 5/8" Type C gypsum wallboard applied perpendicular to the channel with end joints staggered and fastened with 1 1/8" Type S drywall screws spaced 12" o.c. in the field and 8" o.c. at the wallboard ends. Wallboard joints to be taped and covered with joint compound.</p>	<p>Varies</p>	<p>5/8</p>
<p>Wood I-joist (minimum I-joist depth 9 1/4" with a minimum flange depth of 1 1/2" and a minimum flange cross sectional area of 5.25 sq in.; minimum web thickness of 7/16") @ 24" o.c., 1 1/2"</p>	<p>Minimum .019" thick resilient channel 16" o.c. (channels doubled at wallboard end joints), placed perpendicular to the joist and attached to each joist by 1 5/8" Type S drywall screws. 5/8" Type C gypsum wallboard applied perpendicular to the channel with end joints staggered</p>	<p>Varies</p>	<p>5/8</p>

<p>mineral wool insulation (2.5 pcf nominal) resting on resilient channels.</p>	<p>and fastened with 1" Type S drywall screws spaced 12" o.c. in the field and 8" o.c. at the wallboard ends. Wallboard joints to be taped and covered with joint compound.</p>		
<p>Wood I-joint (minimum I-joint depth 9 1/4" with a minimum flange depth of 1 1/2" and a minimum flange cross sectional area of 2.25 sq in.; minimum web thickness of 3/8") @ 24" o.c.</p>	<p>Two layers of 1/2" Type X gypsum wallboard with the long dimension perpendicular to the I-joists with end joints staggered. The base layer is fastened with 1 5/8" Type S drywall screws spaced 12" o.c. and the face layer is fastened with 2" Type S drywall screws spaced 12" o.c. in the field and 8" o.c. on the edges. Face layer end joints shall not occur on the same I-joint as base layer end joints and edge joints shall be offset 24" from base layer joints. Face layer to also be attached to base layer with 1 1/2" Type G drywall screws spaced 8" o.c. placed 6" from face layer end joints. Face layer wallboard joints to be taped and covered with joint compound.</p>	<p>Varies</p>	<p>1</p>
<p>Wood I-joint (minimum I-joint depth 9 1/2" with a minimum flange depth of 1 5/16" and a minimum flange cross sectional area of 1.95 sq in.; minimum web thickness of 3/8") @ 24" o.c.</p>	<p>Minimum .019" thick resilient channel 16" o.c. (channels doubled at wallboard end joints), placed perpendicular to the joist and attached to each joist by 1 5/8" Type S drywall screws. Two layers of 1/2" Type X gypsum wallboard with the long dimension perpendicular to the I-joists with end joints staggered. The base layer is fastened with 1 1/4" Type S drywall screws spaced 12" o.c. and the face layer is fastened with 1 5/8" Type S drywall screws spaced 12" o.c. Face layer end joints shall not occur on the same I-joint as base layer end joints and edge joints shall be offset 24" from base layer joints. Face layer to also be attached to base layer with 1 1/2" Type G drywall screws spaced 8" o.c. placed 6" from face layer end joints. Face layer wallboard joints to be taped and covered with joint compound.</p>	<p>Varies</p>	<p>1</p>

<p>Wood I-joint (minimum I-joint depth 9 1/4" with a minimum flange depth of 1 1/2" and a minimum flange cross sectional area of 2.25 sq in.; minimum web thickness of 3/8") @ 24" o.c. Unfaced fiberglass insulation is installed between the I-joists supported on the upper surface on the flange by stay wires spaced 12" o.c.</p>	<p>Base layer of 5/8" Type C gypsum wallboard attached directly to I-joists with 1 5/8" Type S drywall screws spaced 12" o.c. with ends staggered. Minimum .0179" thick hat-shaped 7/8" furring channel 16" o.c. (channels doubled at wallboard end joints), placed perpendicular to the joist and attached to each joist by 1 5/8" Type S drywall screws after the base layer of gypsum wallboards has been applied. The middle and face layers of 5/8" Type C gypsum wallboard applied perpendicular to the channel with end joint staggered. The middle layer is fastened with 1" Type S drywall screws spaced 12" o.c. The face layer is applied parallel to the middle layer but with the edge joints offset 24" from those of the middle layer and fastened with 1 5/8" Type S drywall screws 8" o.c. the joints shall be taped and covered with joint compound.</p>	<p>Varies</p>	
--	--	---------------	--

4.4 Performance Based Assemblies

There are other options to provide an equivalent 1-hr fire-resistance rating that are not using the above prescriptive construction options. These “performance based” assemblies are specific assemblies and brands that have been tested in their particular arrangement for a specific outcome. They are not general assemblies like that given in Section 4.3. These assemblies must be recreated exactly to ensure the proper fire-resistance rating is provided where required.

The International Code Council – Evaluation Service (ICC-ES) provides an evaluation service that will review a test on any material and assembly for a certain rating or purpose, and then produce an evaluation report on the product. These reports “present findings of ICC-ES as to the compliance with code requirements of the subject of the report- a particular building product, component, method or material” [ICC-ES]. The tests are completed by 3rd party laboratories which are accredited by an accreditation body that is a signatory to the Mutual Recognition Arrangement (MRA) of the International Laboratory Accreditation Cooperation (ILAC) or have an on-site assessment for compliance with the ICC-ES Non Accredited Laboratory Checklist [ICC-ES].

No materials or assemblies could be found that tested positively in the projection orientation for 1-hr of fire resistance. Prescriptive assemblies provide the most accurate way to provide the appropriate 1-hr fire-resistant construction required for the underside of projections.

4.5 Cost Effective Alternatives

There are two options when reviewing the cost of this code change. First is identifying any alternative “engineering judgements” that could be used to provide equivalent protection but have not been specifically prescribed by a test or code. The second option is to review the overall cost savings that would occur if the new code requirements were followed i.e. adding a sprinkler system.

Five designs have been provided to address the protection of both attached and detached zero-lot line buildings. Additionally, Appendix A provides details for ignition resistant eave construction that has been approved by the County of San Diego. The details, however, are not applicable to zero-lot line buildings.

A general cost review of what adding home sprinkler systems would require and save is also included below.

4.5.1 Engineering Judgment

Zero-lot line buildings are built in two different orientations: attached, i.e. townhouses, and detached. Each orientation must be treated individually due to the differences in construction and open spaces between the buildings. A total of five (5) alternative construction designs options were created to provide the required protection for zero-lot line buildings.

4.5.1.1 Detached Zero-Lot Line Buildings

A total of three (3) alternatives have been proposed to create a fire-resistive separation at the underside of any projection while still allowing soffit openings for attic ventilation. The options are described below and corresponding drawings can be found in Appendix B.

Option 1 (FS.01.1): The underside of the projection will be constructed to provide a 1-hr fire rating. The soffit opening will be provided at the eave and will be protected by a fire-rated damper.

Option 2 (FS.01.2): The underside of the projection will be constructed to provide a 1-hr fire rating. The ducted opening will be provided high on the exterior wall of the building, protected by a fire-rated damper. This opening will be ducted to the attic to ensure adequate ventilation is provided.

Option 3 (FS.01.3): The underside of the projection will be constructed to provide a fire-rated opening protective via a matrix of fire pillows. The fire pillows will be provided in a steel grid matrix that allows for the expansion of the pillows to fill in ventilation gaps during a fire scenario. The recommended type of pillow to be used is Quelfire Fire Stop Pillows, see Appendix C for its technical data sheet. However, there are other manufacturers of listed fire pillows. The gaps between the pillows should be calculated to ensure adequate ventilation is provided. The fire pillow manufacturer should be consulted to confirm acceptable gap spacing to ensure their product will adequately seal the gaps during fire exposure. For example, per Appendix

C's Size Table, a 0.10 sq m opening will be protected by two (2) of the PS 300 sized pillows (300 mm x 100 mm) with 20% of the area i.e. .02 sq m open for ventilation.

4.5.1.2 Attached Zero-Lot Line Buildings

A total of two (2) alternatives have been designed to ensure adequate protection is provided for both inline and offset townhouses. The options are described below and corresponding drawings can be found in Appendix B.

Option 1 (FS.01.4): For inline attached buildings, fire block will be provided as a continuation of the fire wall/ party wall within the soffit. Four (4) ft on both sides of the fire block must be solid without openings. Other than within the two four (4) ft no opening zones, the soffit may be open to provide adequate ventilation.

Option 2 (FS.01.5): For offset attached buildings, fire block will be provided as a continuation of the fire wall/ party wall within the soffit. Four (4) ft on both sides of the fire block must be solid without openings. Other than within the two four (4) ft no opening zones, the soffit may be open to provide adequate ventilation.

4.5.2 Cost of Code Compliance

The code compliant options available for zero lot line buildings are broken into two categories: sprinkler protected buildings or non sprinkler protected buildings. There are costs involved with both choices.

Sprinkler protecting an entire subdivision is a larger upfront cost, but permits allowances to be taken within the IRC and IBC. On average, a residential sprinkler system will cost about \$1.50 per sq ft, and also often leads to tax incentives and insurance savings ranging from 5-15% according to the National Association of Home Builders. It is hard to accurately determine if these saving offset the upfront cost to the owner which causes a larger mortgage payment. However, adding sprinkler systems affects the spending of more than just the homeowners. Through builder incentives and code allowances, developers can save up to \$1,271 per building lot per year according to a 2010 Fire Protection Research Foundation report by Newport Partners LLC.

Non-sprinkler protected subdivisions do not have the upfront cost of adding a sprinkler system, but do have to provide additional construction costs because of code requirements such as the 1-hr underside fire rating on projections. All options to provide 1-hr fire-resistance protection to the underside of a projection are costly and specific in how the assemblies should be constructed. The 2015 IRC provides an option that allows the 1-hr underside protection requirement to be reduced to 0 hrs when the roof vents are relocated from within the projections to the roof ridge and fireblocking is used to block off the projections from the remainder of the roof.

The allowance provided in the 2015 IRC is applicable in both the sprinkler protected and non-sprinkler protected building tables, and as such, still provides allowances for zero lot line buildings even when the buildings are not sprinkler protected. Following the 2015 IRC is the most cost effective way of addressing projection protection in non-sprinkler protected developments. Moving roof vents and providing fireblocking are significantly less expensive and are easier to install than providing 1-hr fire-resistance rated construction for the projections.

5. CONCLUSION

This report contains the requirements and construction options for zero lot line buildings allowed in the IRC and therefore, the FBC-R. It provides prescriptive and performance based options to provide the required protection for projections and the best cost effective alternatives to those fire-resistance rated assemblies.

Koffel Associates trusts that this report provides the information needed to assist in Florida adopting the 2015 IRC into their next code adoption.

Prepared by:



Kristin Steranka
Fire Protection Engineer

Reviewed by:



Clay Aler, P.E.
Principal
Licensed in DC, DC, MD, VA

APPENDIX A

COUNTY OF SAN DIEGO EAVE CONSTRUCTION DETAILS



County of San Diego, Planning & Development Services
IGNITION RESISTANT EAVE CONSTRUCTION
BUILDING DIVISION

GUIDANCE DOCUMENT

Since the 1980s, the County's fire and building codes have been strengthened in successive code adoption cycles with the primary goal of protecting the safety of our citizens and enhancing a home's ability to survive a wildfire. Although such measures protected many homes located within the areas impacted by the 2003 and 2007 wildfires, analysis of the burned homes identified areas where we could improve our codes; one of these areas is eave construction.

Winds in wildfires carry huge amounts of burning embers, swirling into cracks and crevices, igniting anything that is combustible. Eaves, because they are perpendicular to the wall, tend to capture blowing embers. Eave vents, which are designed to move air in and out of the attic, give opportunity for embers to ignite soffit material or enter attic areas. Once a fire starts in an attic, it goes undetected for some time and is very difficult to stop even under ideal conditions.

As a result, improvements were made to the County's codes to establish a series of permissible ignition resistant eave construction details. To determine which detail will be allowed on your structure, first determine whether you are able to maintain 100 feet of defensible space completely around the structure in accordance with the Fuel Modification requirements of the County Fire Code. The fuel modification zone shall be located entirely on the subject property.

- **When 100 foot of defensible space will be provided** any of the details listed in the following Ignition Resistant Eave Construction chart may be used.
- **When 100 foot of defensible space is not provided.** While it is always desirable to have at least 100 feet of defensible space around all structures in the Wildland-Urban Interface Fire Area, there are situations where the required fuel modification cannot be achieved on the parcel, or where steep terrain, high fuel loads, or other special circumstances create additional hazard. In these cases only the most ignition resistive details may be used.

Once you have determined the amount of defensible space that can be created on your property, consult the attached Ignition Resistant Eave Construction chart for a listing of the different types of eave construction that will be allowed for your structure. For every eave description in the chart there is a corresponding detail attached. In addition, each detail can be downloaded individually in AutoCAD DWG file format at: <http://www.co.san-diego.ca.us/pds/bldgforms/eaveindex.html>.

Eave construction on an addition may match the existing structure provided that the area of the addition does not exceed 50% of the existing structure or 2,500 square feet, whichever is less. The vents in these eaves must still comply with current County codes requiring resistance to intrusion of flames and embers.

While these standards will provide a high level of protection to structures built in the wildland-urban interface area, there is no guarantee that compliance with these standards will prevent damage or destruction of structures by fire in all cases. For more information on eave construction or other fire code requirements, please refer to the Wildland-Urban Interface – 2008 Code Changes handout (PDS #664) or contact the Fire Services Division at (858) 565-5920.

#	EAVE CONSTRUCTION DESCRIPTION	WITH 100'		WITHOUT 100'	
		Eave Allowed?	Vent Allowed?	Eave Allowed?	Vent Allowed?
1	Stucco Soffit with Fascia Protected. Horizontal soffit or angled overhang and 2x fascia enclosed with 7/8" Portland cement plaster	Y	Y ¹	Y	N ²
2	Stucco Soffit with Fascia Exposed. Horizontal soffit or angled overhang with 7/8" Portland cement plaster, exposed 2x fascia	Y	Y ¹	NOT ALLOWED	
3	Foam Trim with Stucco. 7/8" Portland cement plaster with foam trim over brown coat and enclosed with color coat	Y	N	Y	N ²
4	Heavy Timber. Exposed rafter tails (4 x 6 or larger), supporting 2" T&G roof decking (If fascia is used it must be 3 x 6 or larger)	Y	N	Y	N ²
5	Exposed Wood with Drywall Underlayment. Soffit enclosed with 1/2" Type X gypsum wallboard under 1x smooth finished starterboard, tight-fitting or caulked. 2x fascia.	Y	Y ¹	NOT ALLOWED	
6	Wood Soffit, Fascia Exposed, with Fire-Resistive Underlayment. 2x wood fascia as plant-on over 5/8" Type X gypsum wallboard or 7/8" Portland cement plaster or 2-2x wood blocking. Soffit may be constructed of combustible material with a 1/4" minimum thickness over 5/8" Type X gypsum wallboard or 7/8" Portland cement plaster.	Y	Y ¹	Y	N ²
7	Cementitious Siding on Soffit and as Underlayment Behind Fascia. 1/4" min. thickness non-combustible cementitious siding on soffit. 2x wood fascia installed over backing of cementitious siding backing or other backing as approved in detail #6.	Y	Y ¹	Y	N ²
8	Cementitious Siding on Soffit 1/4" min. thickness non-combustible cementitious siding – 2x fascia without underlayment	Y	Y ¹	NOT ALLOWED	
9	Enclosed Eave with Exposed Wood. Enclosed eave with solid combustible materials (wood) 3/4 inch thickness – no exposed rafter tails. All joints must be tight fitting and gaps caulked.	Y	Y ¹	NOT ALLOWED	
10	Open Eave with Exposed Wood. 2x rafter tails with 2x blocking, and 1x exterior grade starterboard or 1/2" CCX plywood. All joints must be tight fitting and gaps caulked.	Y	Y ¹	NOT ALLOWED	
11	Fire Retardant Treated Wood Fascia. 1/4" min. thickness non-combustible cementitious siding or 7/8" Portland cement plaster on soffit. 2x Fire Retardant Treated Wood fascia installed over 2x non- treated backing block.	Y	Y ¹	Y	N ²

¹ Vents are allowed in the eave assembly only under either of the following conditions:

- a) The vents are constructed to resist the intrusion of flames and burning embers.
- b) When approved by the Building Official and the Fire Official, enclosed eaves may be vented on the underside of the eave closest to the fascia provided the closest edge of the vent opening is at least 12 inches from the exterior wall.

² Exception: Vents are allowed in these eave assemblies only when they are constructed to resist the intrusion of flames and burning embers.



County of San Diego, Planning & Development Services
GUIDANCE DOCUMENT - IGNITION RESISTANT EAVES
BUILDING DIVISION

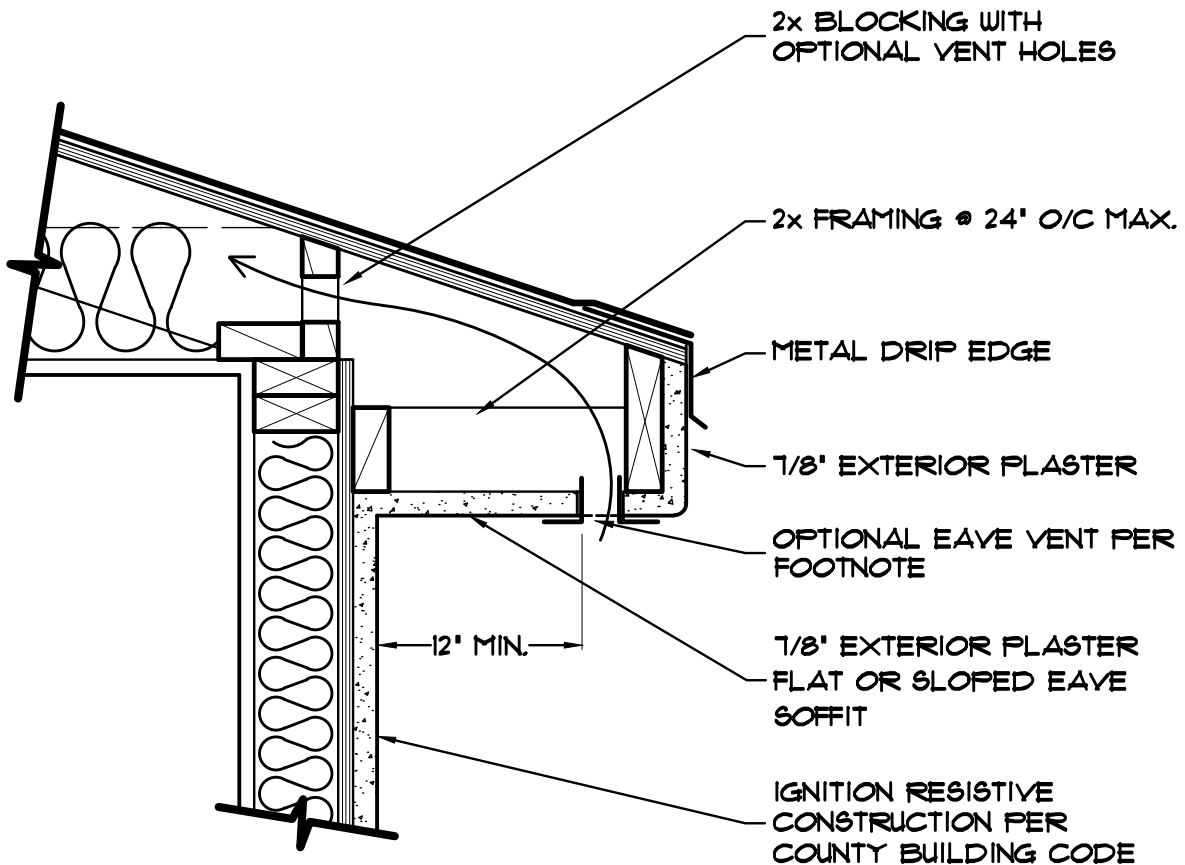

VENTS ARE PERMITTED IN THE EAVE ONLY UNDER EITHER OF THE FOLLOWING CONDITIONS:

- A) THE VENTS ARE CONSTRUCTED TO RESIST THE INTRUSION OF FLAMES AND BURNING EMBERS.
- B) WHEN APPROVED BY THE BUILDING OFFICIAL AND THE FIRE OFFICIAL, ENCLOSED EAVES MAY BE VENTED ON THE UNDERSIDE OF THE EAVE CLOSEST TO THE FASCIA PROVIDED THE CLOSEST EDGE OF THE VENT OPENING IS AT LEAST 12 INCHES FROM THE EXTERIOR WALL.

DATE: 09-24-2012

SCALE: NONE

FORM: PDS 198

3

OF 16 SHEETS

**DETAIL 1 - MUST HAVE AT LEAST 100' OF
DEFENSIBLE SPACE ON SITE**

STUCCO SOFFIT WITH FASCIA PROTECTED



County of San Diego, Planning & Development Services
GUIDANCE DOCUMENT - IGNITION RESISTANT EAVES
BUILDING DIVISION

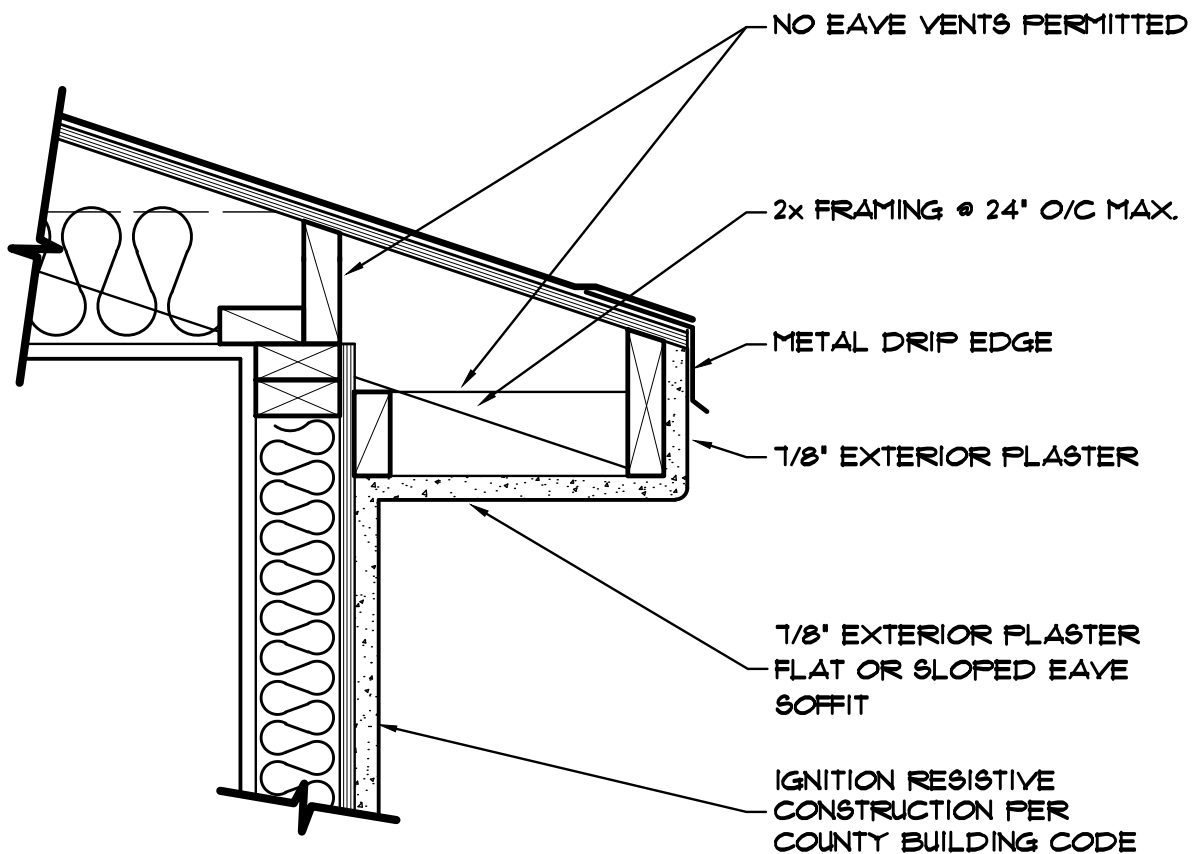

DATE: 09-24-2012

SCALE: NONE

FORM: PDS 198

**DETAIL 1 - ALLOWED
EVERYWHERE**

4

OF 16 SHEETS

STUCCO SOFFIT WITH FASCIA PROTECTED



County of San Diego, Planning & Development Services
GUIDANCE DOCUMENT - IGNITION RESISTANT EAVES
BUILDING DIVISION

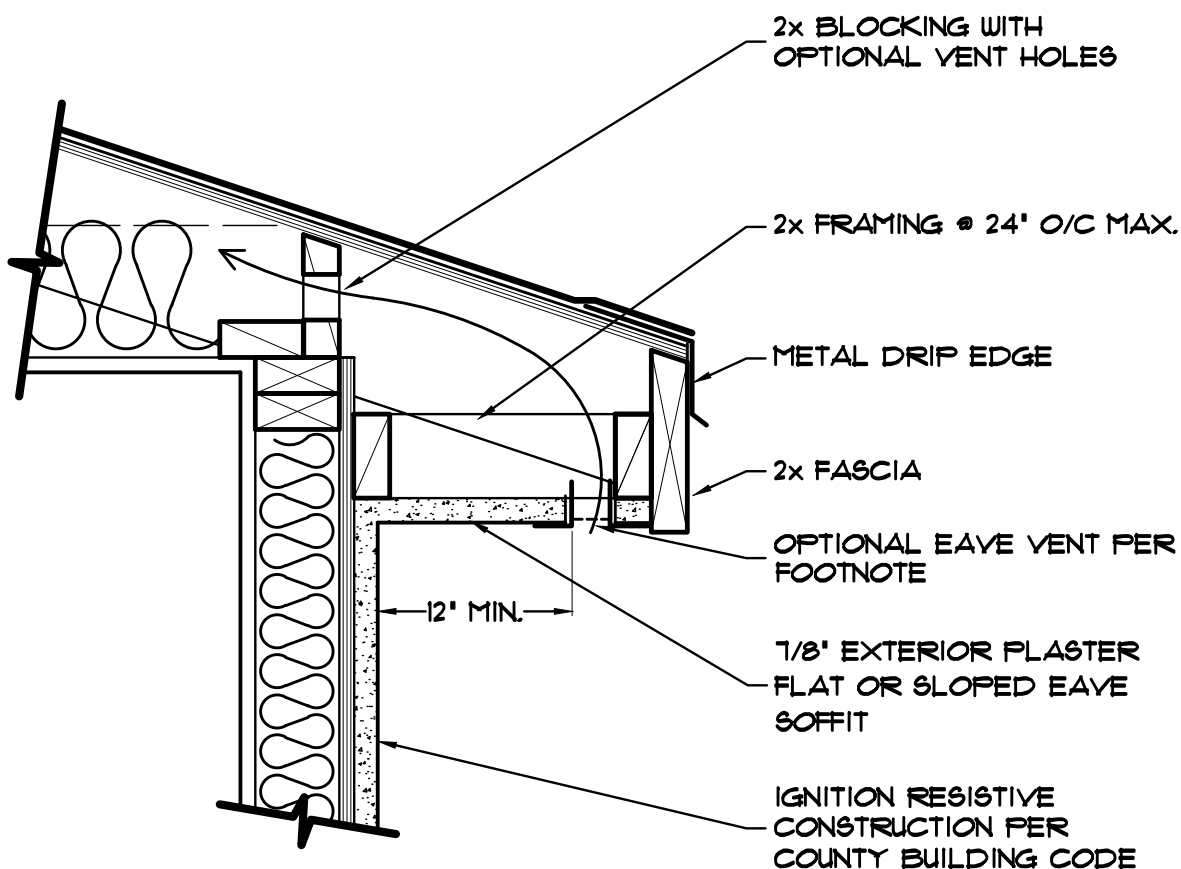

VENTS ARE PERMITTED IN THE EAVE ONLY UNDER EITHER OF THE FOLLOWING CONDITIONS:

- A) THE VENTS ARE CONSTRUCTED TO RESIST THE INTRUSION OF FLAMES AND BURNING EMBERS.
- B) WHEN APPROVED BY THE BUILDING OFFICIAL AND THE FIRE OFFICIAL, ENCLOSED EAVES MAY BE VENTED ON THE UNDERSIDE OF THE EAVE CLOSEST TO THE FASCIA PROVIDED THE CLOSEST EDGE OF THE VENT OPENING IS AT LEAST 12 INCHES FROM THE EXTERIOR WALL.

DATE: 09-24-2012

SCALE: NONE

FORM: PDS 198

**DETAIL 2 - MUST HAVE AT LEAST 100' OF
DEFENSIBLE SPACE ON SITE**

5

STUCCO SOFFIT WITH FASCIA EXPOSED

OF 16 SHEETS



County of San Diego, Planning & Development Services
GUIDANCE DOCUMENT - IGNITION RESISTANT EAVES
BUILDING DIVISION

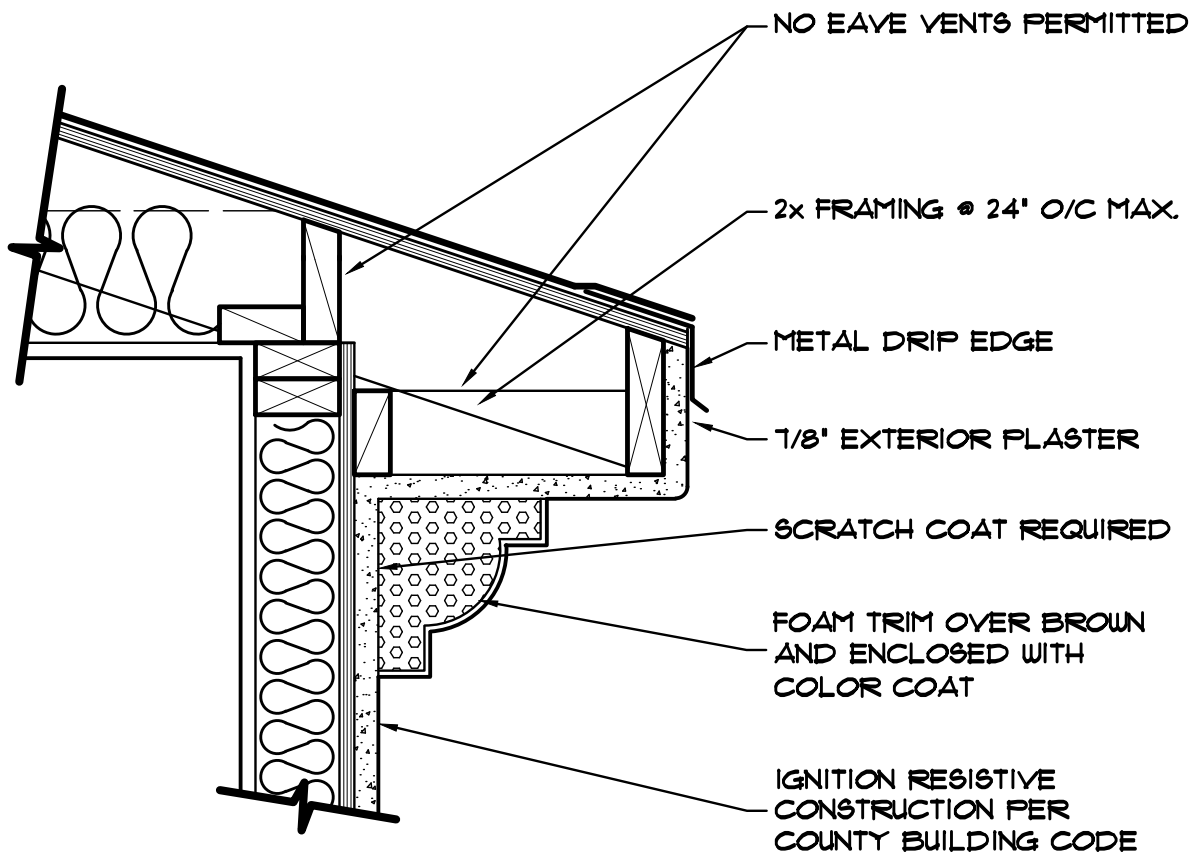

DATE: 09-24-2012

SCALE: NONE

FORM: PDS 198

DETAIL 3 - ALLOWED EVERYWHERE

6

OF 16 SHEETS

FOAM TRIM WITH STUCCO



County of San Diego, Planning & Development Services
GUIDANCE DOCUMENT - IGNITION RESISTANT EAVES
BUILDING DIVISION

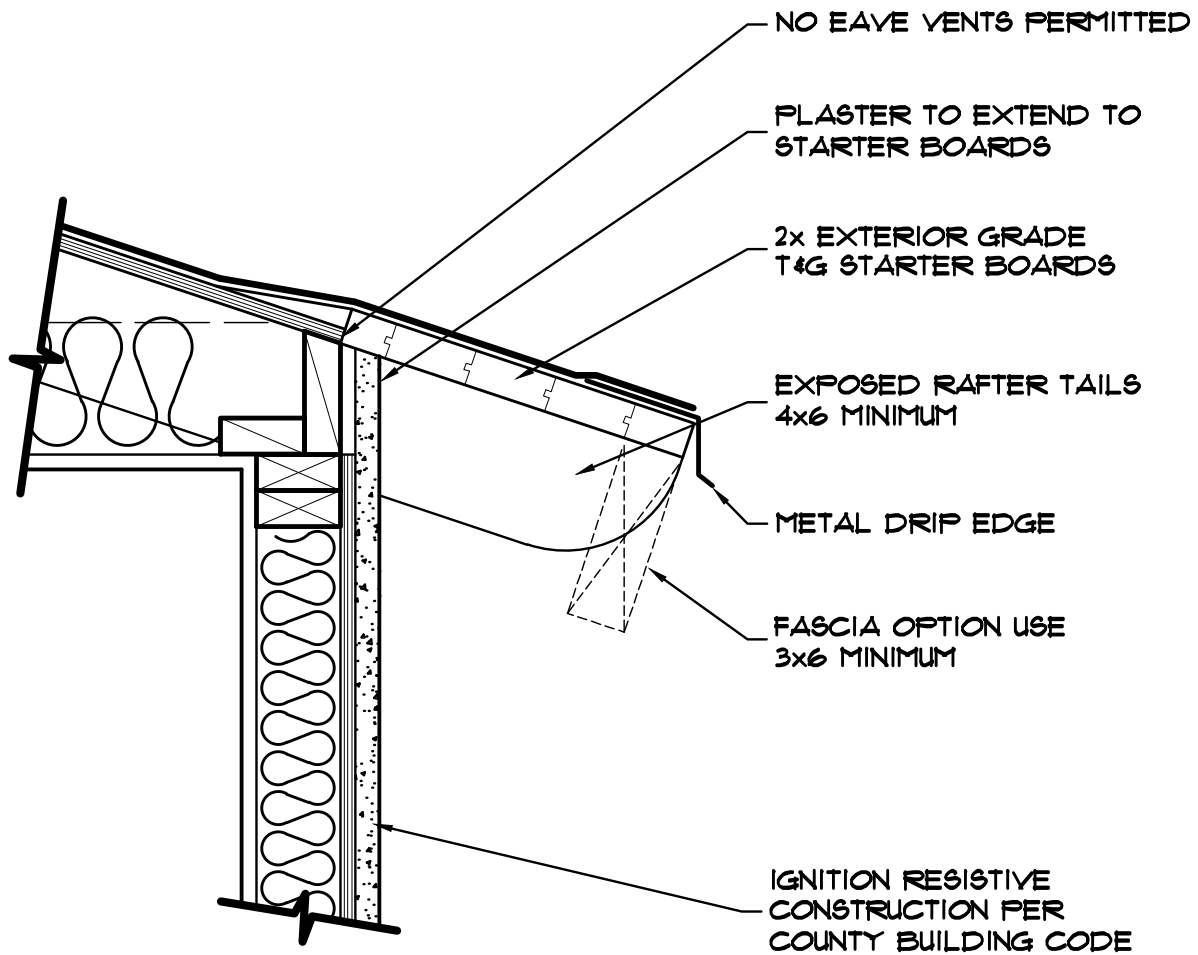

DATE: 09-24-2012

SCALE: NONE

FORM: PDS 198

DETAIL 4 - ALLOWED EVERYWHERE

7

OF 16 SHEETS

HEAVY TIMBER



County of San Diego, Planning & Development Services
GUIDANCE DOCUMENT - IGNITION RESISTANT EAVES
 BUILDING DIVISION

NOTE: ALL JOINTS MUST BE TIGHT FITTING AND CAULKED

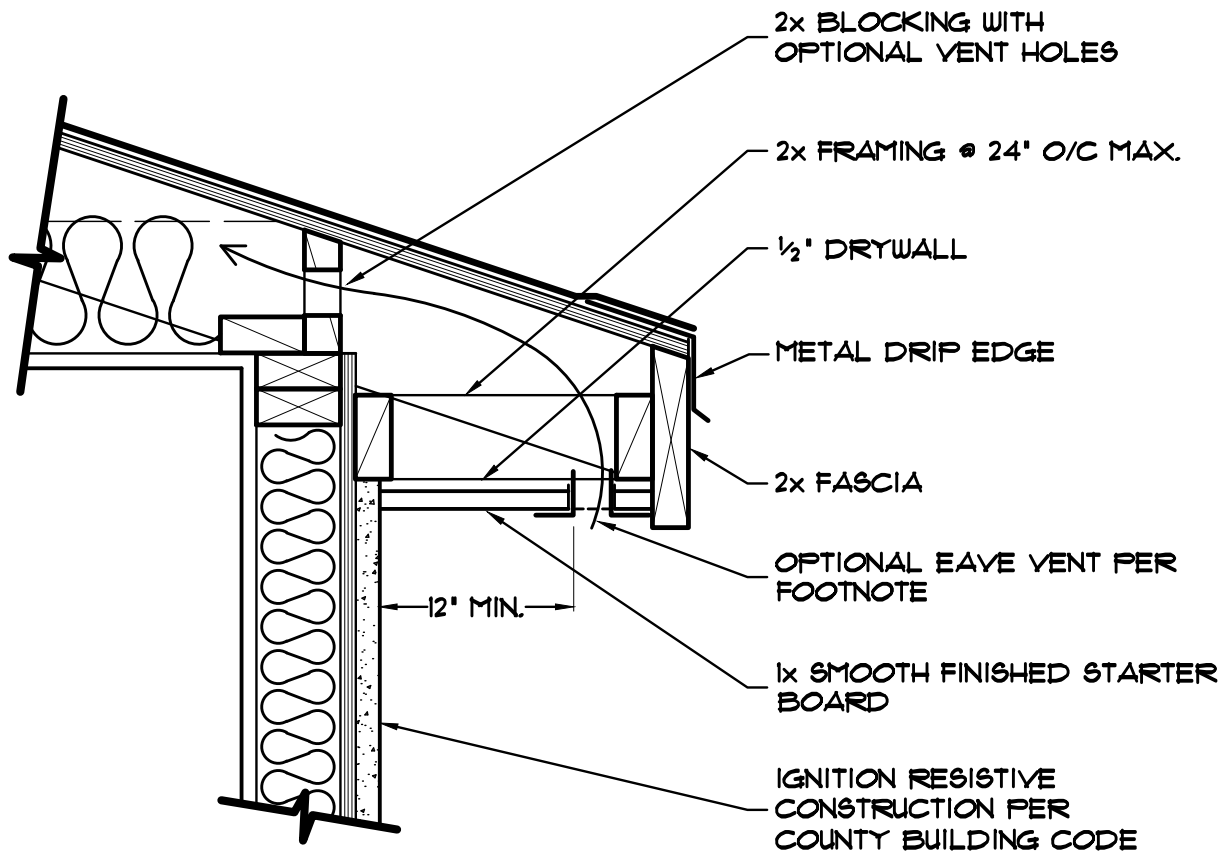

VENTS ARE PERMITTED IN THE EAVE ONLY UNDER EITHER OF THE FOLLOWING CONDITIONS:

- A) THE VENTS ARE CONSTRUCTED TO RESIST THE INTRUSION OF FLAMES AND BURNING EMBERS.
- B) WHEN APPROVED BY THE BUILDING OFFICIAL AND THE FIRE OFFICIAL, ENCLOSED EAVES MAY BE VENTED ON THE UNDERSIDE OF THE EAVE CLOSEST TO THE FASCIA PROVIDED THE CLOSEST EDGE OF THE VENT OPENING IS AT LEAST 12 INCHES FROM THE EXTERIOR WALL.

DATE: 09-24-2012

SCALE: NONE

FORM: PDS 198

DETAIL 5 - MUST HAVE AT LEAST 100' OF DEFENSIBLE SPACE ON SITE

8

OF 16 SHEETS

EXPOSED WOOD WITH DRYWALL UNDERLAYMENT



County of San Diego, Planning & Development Services
GUIDANCE DOCUMENT - IGNITION RESISTANT EAVES
 BUILDING DIVISION

NOTE: ALL JOINTS MUST BE TIGHT FITTING AND CAULKED

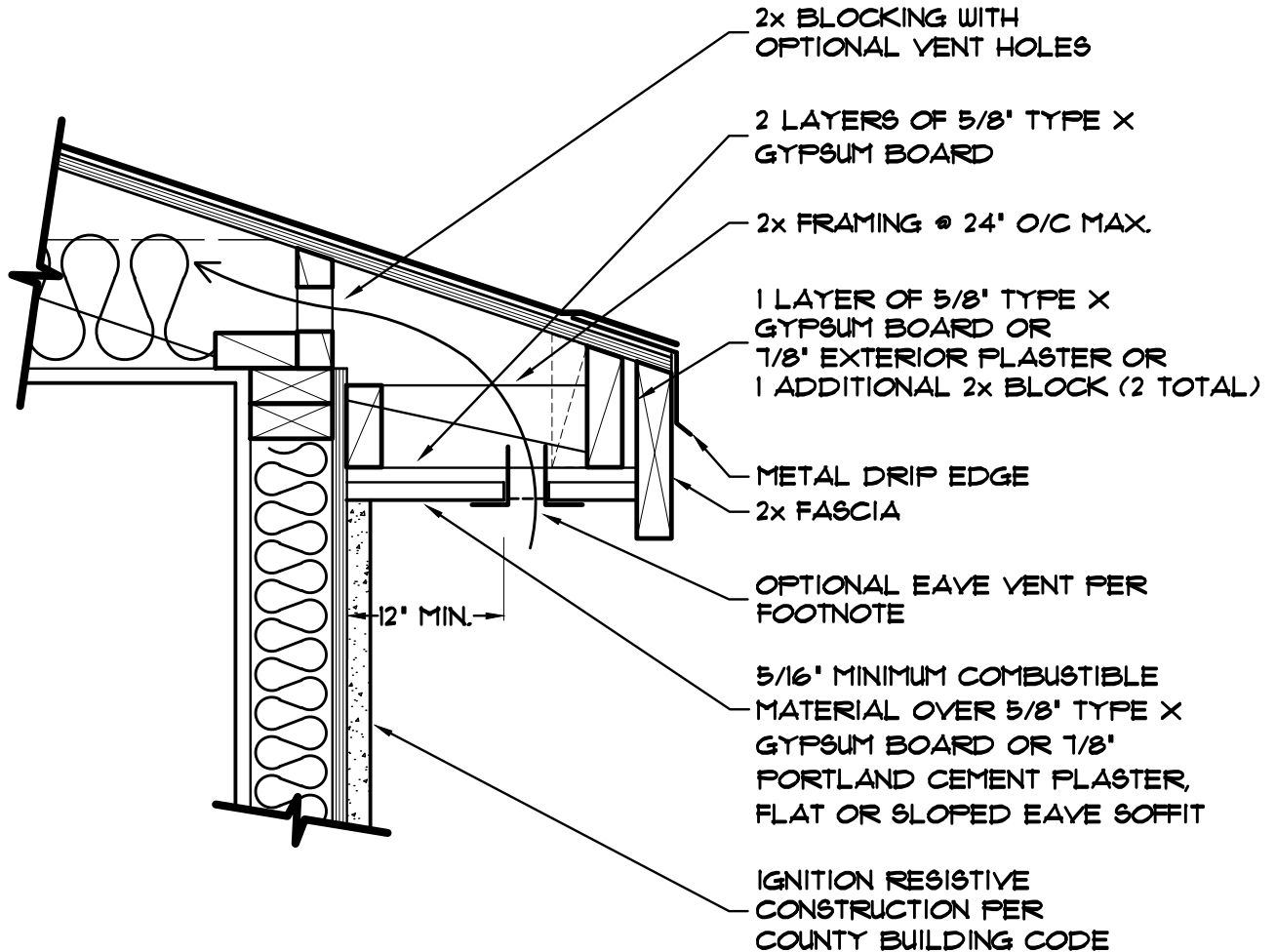

VENTS ARE PERMITTED IN THE EAVE ONLY UNDER EITHER OF THE FOLLOWING CONDITIONS:

- A) THE VENTS ARE CONSTRUCTED TO RESIST THE INTRUSION OF FLAMES AND BURNING EMBERS.
- B) WHEN APPROVED BY THE BUILDING OFFICIAL AND THE FIRE OFFICIAL, ENCLOSED EAVES MAY BE VENTED ON THE UNDERSIDE OF THE EAVE CLOSEST TO THE FASCIA PROVIDED THE CLOSEST EDGE OF THE VENT OPENING IS AT LEAST 12 INCHES FROM THE EXTERIOR WALL.

DATE: 09-24-2012

SCALE: NONE

FORM: PDS 198

DETAIL 6 - MUST HAVE AT LEAST 100' OF DEFENSIBLE SPACE ON SITE

9

OF 16 SHEETS

WOOD SOFFIT FASCIA EXPOSED WITH FIRE RESISTIVE UNDERLAYMENT



County of San Diego, Planning & Development Services
GUIDANCE DOCUMENT - IGNITION RESISTANT EAVES
BUILDING DIVISION

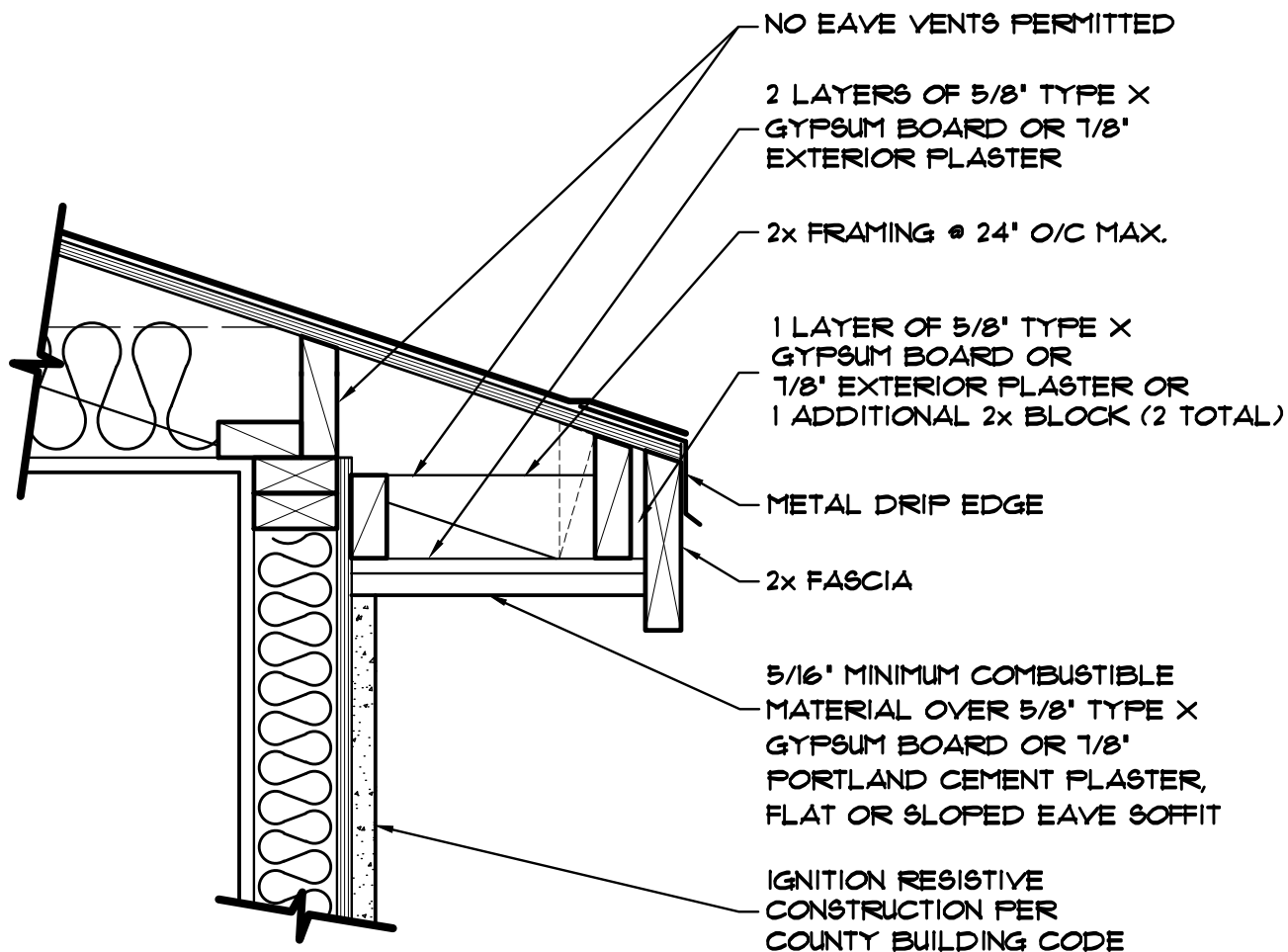

DATE: 09-24-2012

SCALE: NONE

FORM: PDS 198

10

OF 16 SHEETS

DETAIL 6 - ALLOWED EVERYWHERE

WOOD SOFFIT FASCIA EXPOSED WITH FIRE RESISTIVE UNDERLAYMENT



County of San Diego, Planning & Development Services
GUIDANCE DOCUMENT - IGNITION RESISTANT EAVES
 BUILDING DIVISION

NOTE: ALL JOINTS MUST BE TIGHT FITTING AND CAULKED

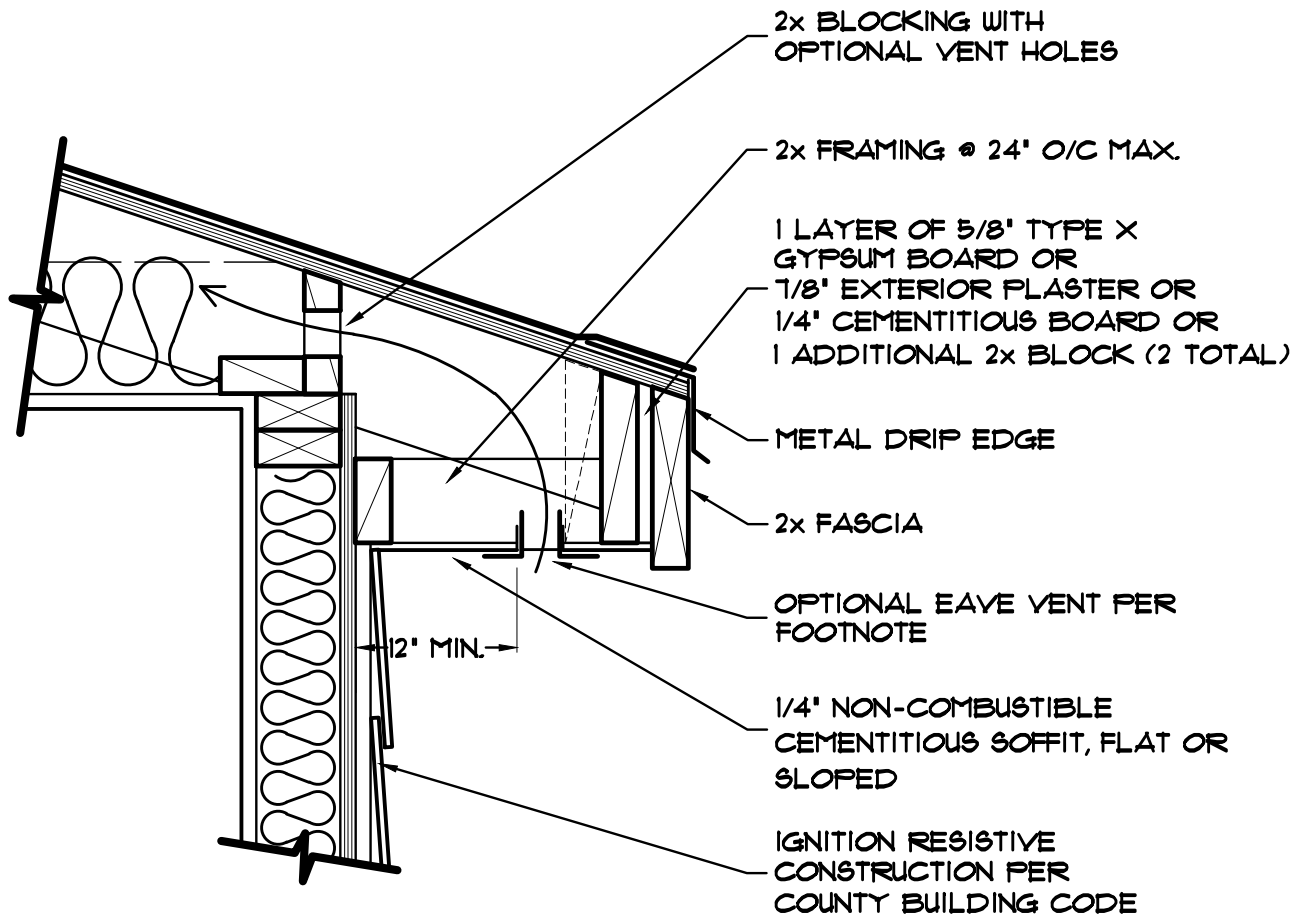

VENTS ARE PERMITTED IN THE EAVE ONLY UNDER EITHER OF THE FOLLOWING CONDITIONS:
 A) THE VENTS ARE CONSTRUCTED TO RESIST THE INTRUSION OF FLAMES AND BURNING EMBERS.
 B) WHEN APPROVED BY THE BUILDING OFFICIAL AND THE FIRE OFFICIAL, ENCLOSED EAVES MAY BE VENTED ON THE UNDERSIDE OF THE EAVE CLOSEST TO THE FASCIA PROVIDED THE CLOSEST EDGE OF THE VENT OPENING IS AT LEAST 12 INCHES FROM THE EXTERIOR WALL.

DATE: 09-24-2012

SCALE: NONE

FORM: PDS 198

DETAIL 7 - MUST HAVE AT LEAST 100' OF DEFENSIBLE SPACE ON SITE

11

OF 16 SHEETS

CEMENTITIOUS SIDING ON SOFFIT AND AS UNDERLAYMENT BEHIND FASCIA



County of San Diego, Planning & Development Services
GUIDANCE DOCUMENT - IGNITION RESISTANT EAVES
BUILDING DIVISION

NOTE: ALL JOINTS MUST BE TIGHT FITTING AND CAULKED

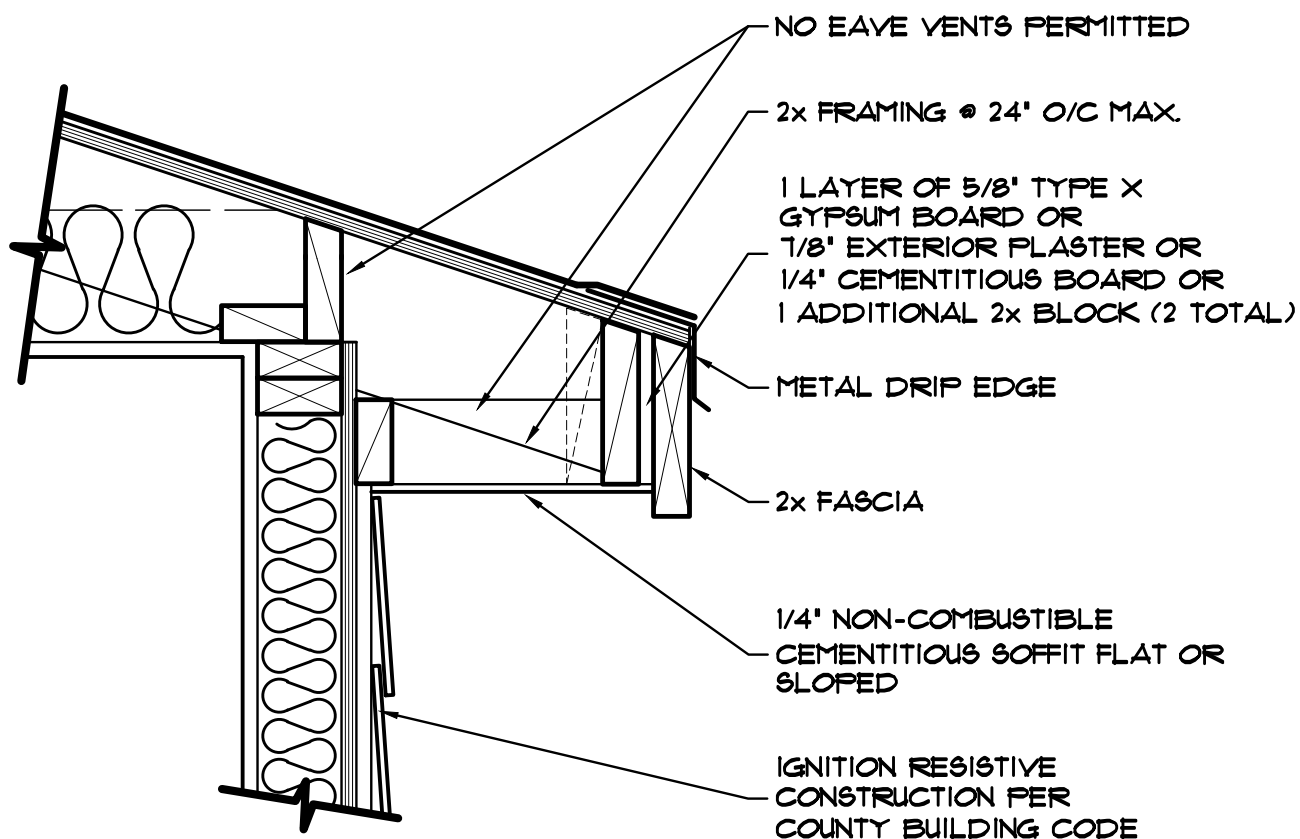

DATE: 09-24-2012

SCALE: NONE

FORM: PDS 198

12

OF 16 SHEETS

DETAIL 7 - ALLOWED EVERYWHERE

CEMENTITIOUS SIDING ON SOFFIT AND AS UNDERLAYMENT BEHIND FASCIA



County of San Diego, Planning & Development Services
GUIDANCE DOCUMENT - IGNITION RESISTANT EAVES
BUILDING DIVISION

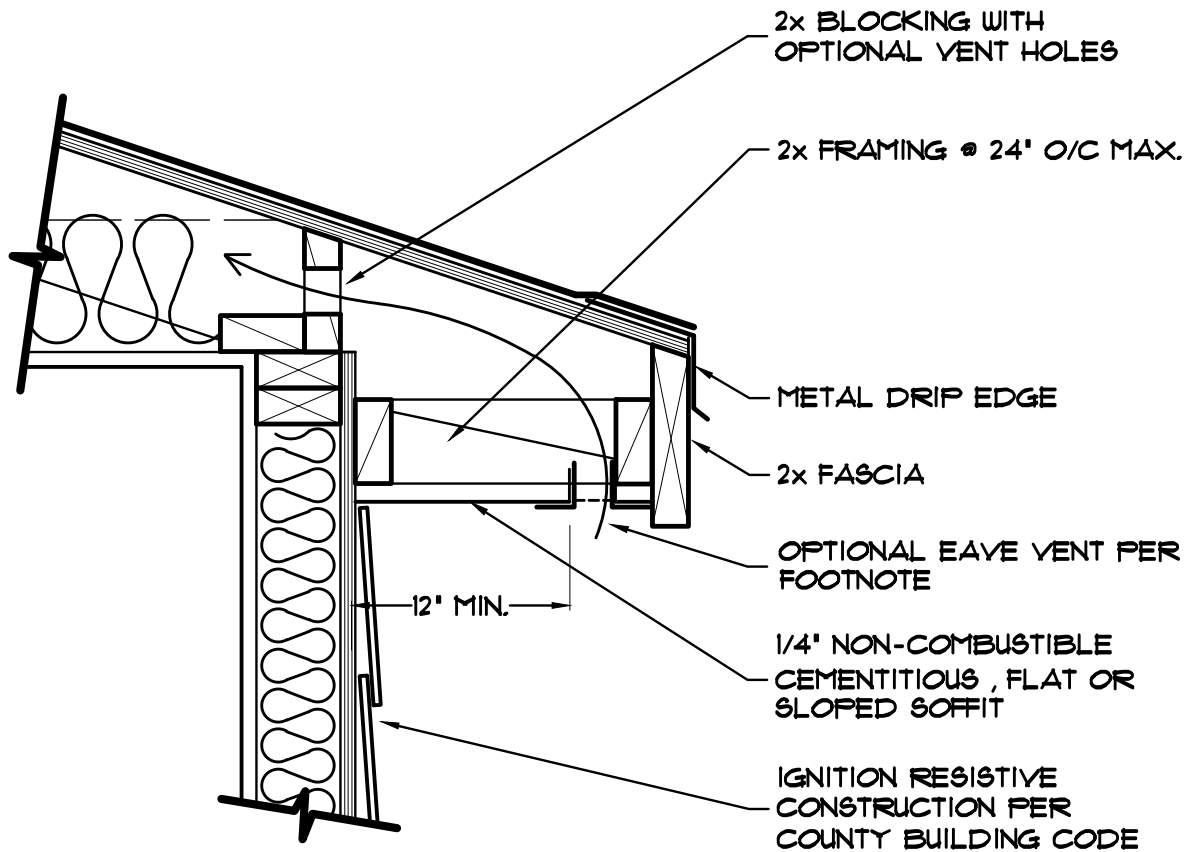

VENTS ARE PERMITTED IN THE EAVE ONLY UNDER EITHER OF THE FOLLOWING CONDITIONS:

- A) THE VENTS ARE CONSTRUCTED TO RESIST THE INTRUSION OF FLAMES AND BURNING EMBERS.
- B) WHEN APPROVED BY THE BUILDING OFFICIAL AND THE FIRE OFFICIAL, ENCLOSED EAVES MAY BE VENTED ON THE UNDERSIDE OF THE EAVE CLOSEST TO THE FASCIA PROVIDED THE CLOSEST EDGE OF THE VENT OPENING IS AT LEAST 12 INCHES FROM THE EXTERIOR WALL.

DATE: 09-24-2012

SCALE: NONE

FORM: PDS 198

DETAIL 8 - MUST HAVE AT LEAST 100' OF DEFENSIBLE SPACE ON SITE

13

OF 16 SHEETS

CEMENTITIOUS SIDING ON SOFFIT



County of San Diego, Planning & Development Services
GUIDANCE DOCUMENT - IGNITION RESISTANT EAVES
BUILDING DIVISION

NOTE: ALL JOINTS MUST BE TIGHT FITTING AND CAULKED

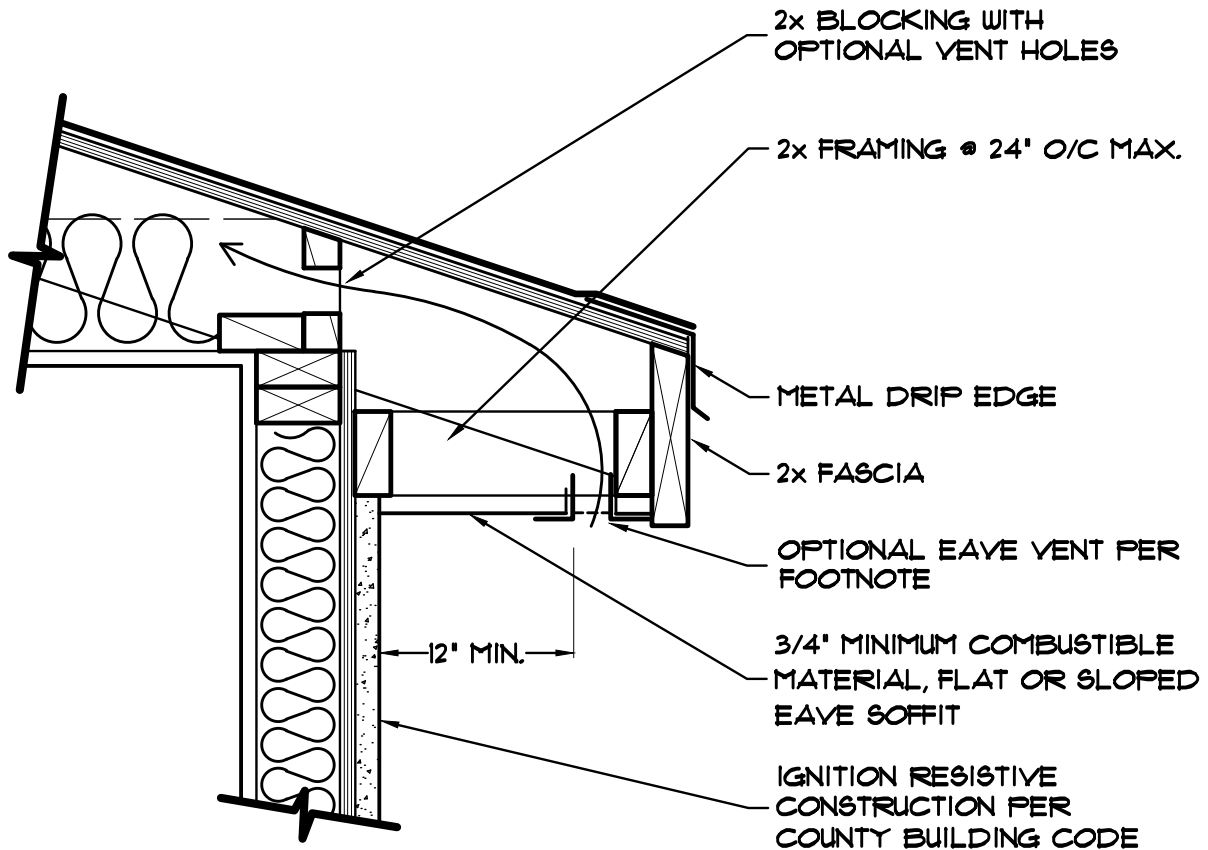

VENTS ARE PERMITTED IN THE EAVE ONLY UNDER EITHER OF THE FOLLOWING CONDITIONS:

- A) THE VENTS ARE CONSTRUCTED TO RESIST THE INTRUSION OF FLAMES AND BURNING EMBERS.
- B) WHEN APPROVED BY THE BUILDING OFFICIAL AND THE FIRE OFFICIAL, ENCLOSED EAVES MAY BE VENTED ON THE UNDERSIDE OF THE EAVE CLOSEST TO THE FASCIA PROVIDED THE CLOSEST EDGE OF THE VENT OPENING IS AT LEAST 12 INCHES FROM THE EXTERIOR WALL.

DATE: 09-24-2012

SCALE: NONE

FORM: PDS 198

**DETAIL 9 - MUST HAVE AT LEAST 100' OF
DEFENSIBLE SPACE ON SITE**

14

OF 16 SHEETS

ENCLOSED EAVE WITH EXPOSED WOOD



County of San Diego, Planning & Development Services
GUIDANCE DOCUMENT - IGNITION RESISTANT EAVES
BUILDING DIVISION

NOTE: ALL JOINTS MUST BE TIGHT FITTING AND CAULKED

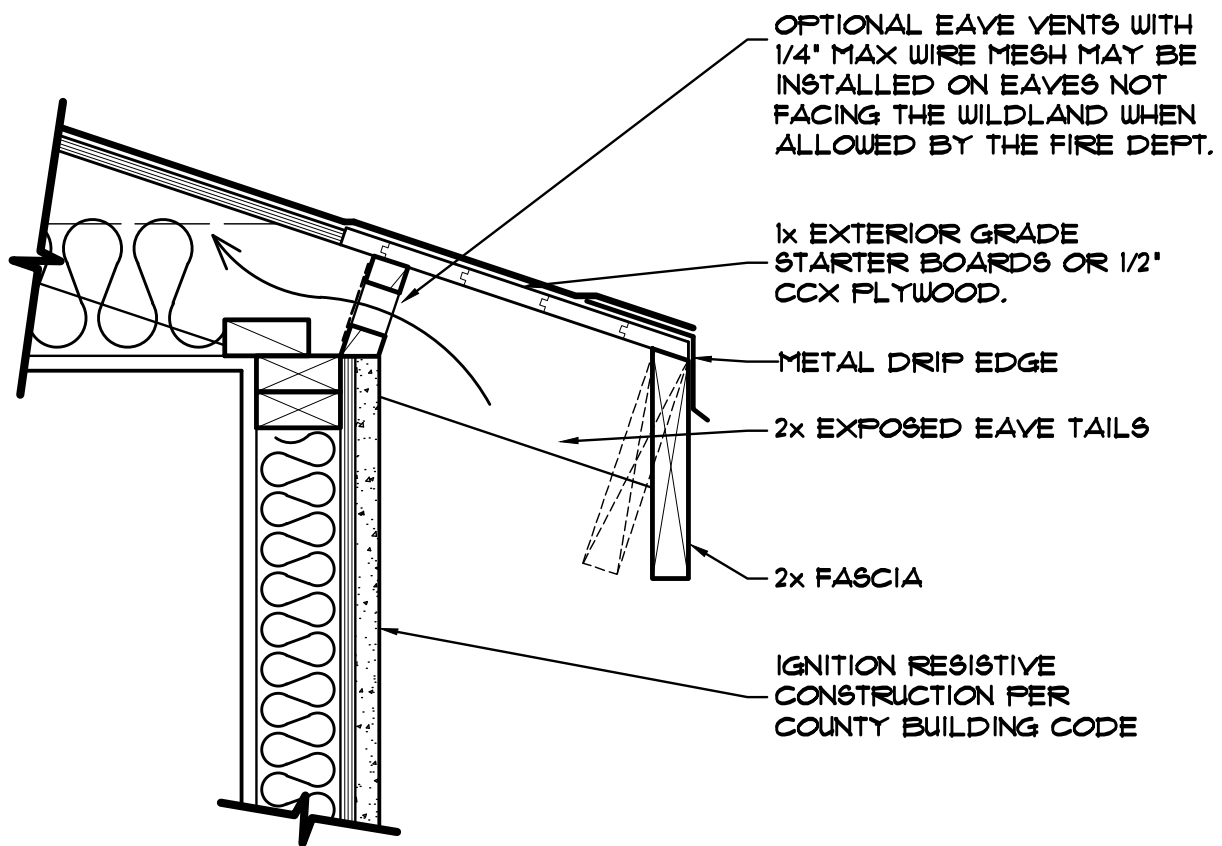

VENTS ARE PERMITTED IN THE EAVE ONLY UNDER EITHER OF THE FOLLOWING CONDITIONS:

- A) THE VENTS ARE CONSTRUCTED TO RESIST THE INTRUSION OF FLAMES AND BURNING EMBERS.
- B) WHEN APPROVED BY THE BUILDING OFFICIAL AND THE FIRE OFFICIAL, ENCLOSED EAVES MAY BE VENTED ON THE UNDERSIDE OF THE EAVE CLOSEST TO THE FASCIA PROVIDED THE CLOSEST EDGE OF THE VENT OPENING IS AT LEAST 12 INCHES FROM THE EXTERIOR WALL.

DATE: 09-24-2012

SCALE: NONE

FORM: PDS 198

DETAIL 10 - MUST HAVE AT LEAST 100' OF DEFENSIBLE SPACE ON SITE

15

OF 16 SHEETS

OPEN EAVE WITH EXPOSED WOOD



County of San Diego, Planning & Development Services
GUIDANCE DOCUMENT - IGNITION RESISTANT EAVES
BUILDING DIVISION

NOTE: ALL JOINTS MUST BE TIGHT FITTING AND CAULKED

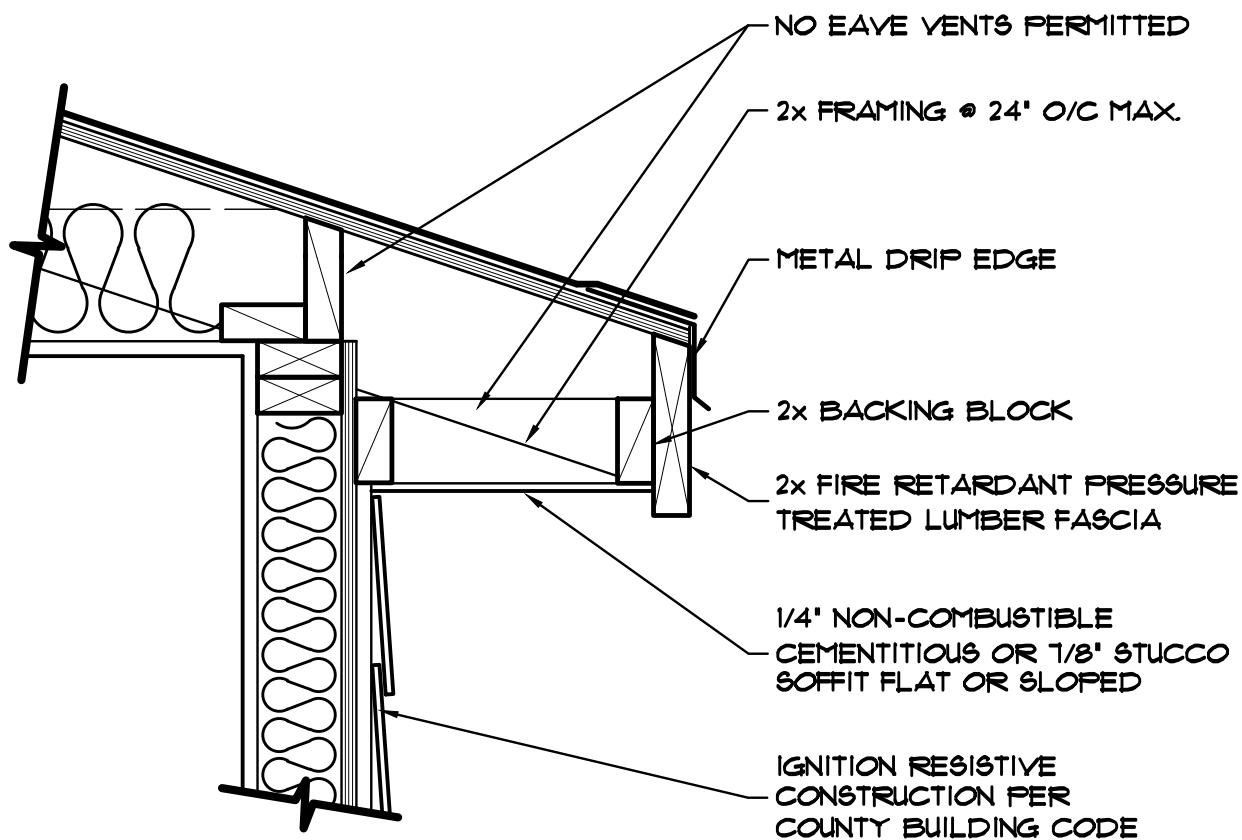

FIRE RETARDANT LUMBER:
USE EITHER EXTERIOR FIRE-X RETARDANT TREATED LUMBER,
CA SFM LISTING 2520-1701:100, OR FRX FIRE RETARDANT
TREATED WOOD, E6R-1159.

ALL FIRE RETARDANT TREATED LUMBER SHALL NOT TO BE LEFT UNFINISHED.

DATE: 09-24-2012

SCALE: NONE

FORM: PDS 198

16

OF 16 SHEETS





DETAIL 11 - ALLOWED EVERYWHERE

EXPOSED FIRE RETARDANT TREATED WOOD FASCIA

APPENDIX B

ENGINEERING JUDGEMENT DETAILS

REVISIONS		
NO	DATE	DESCRIPTION
1	5-09-16	EAVE PROTECTION

LEGEND	
	1 HR FIRE SEPARATION
	1 HR DAMPER
	FIRE BLOCKING
	FIRE PILLOW

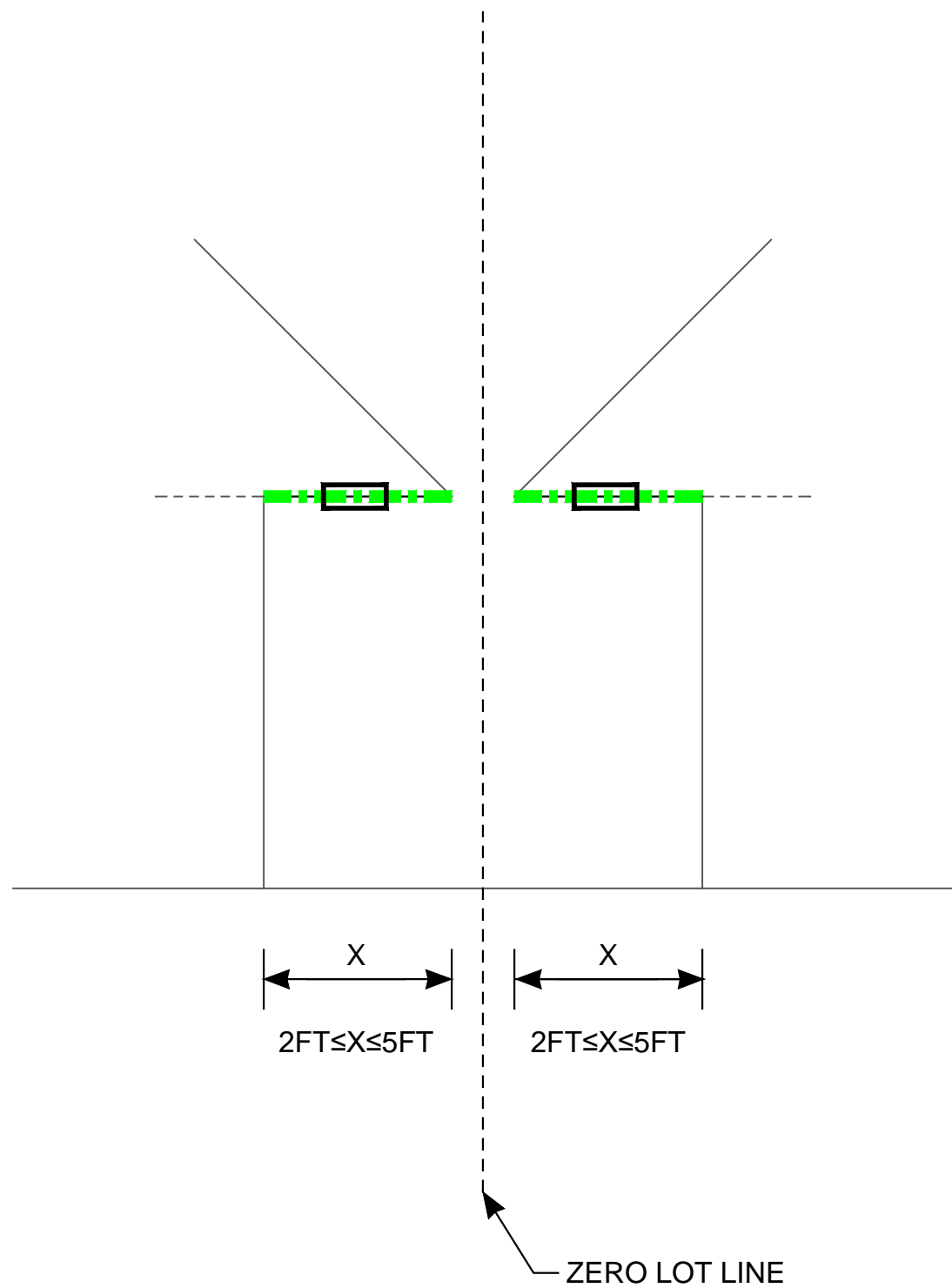

DETACHED - OPTION 1
 NOT TO SCALE

ENGINEER'S SEAL

INTERNATIONAL RESIDENTIAL CODE CHANGES
 PROJECT TITLE





CONSULTANT

MAY 20, 2016	U013-03
SUBMITTAL DATE	KA PROJECT NO
AS NOTED	FULL SIZE
DRAWING SCALE	PLOT SCALE
K. CUSTODIO	K. STERANKA
DRAWN BY	DESIGNED BY
C. AYLER	C. AYLER
REVIEWED BY	APPROVED BY

DETACHED ZERO-LOT LINE OPTIONS
 SHEET TITLE

FS.01.1
 DRAWING NUMBER

REVISIONS		
NO	DATE	DESCRIPTION
1	5-09-16	EAVE PROTECTION

LEGEND	
	1 HR FIRE SEPARATION
	1 HR DAMPER
	FIRE BLOCKING
	FIRE PILLOW

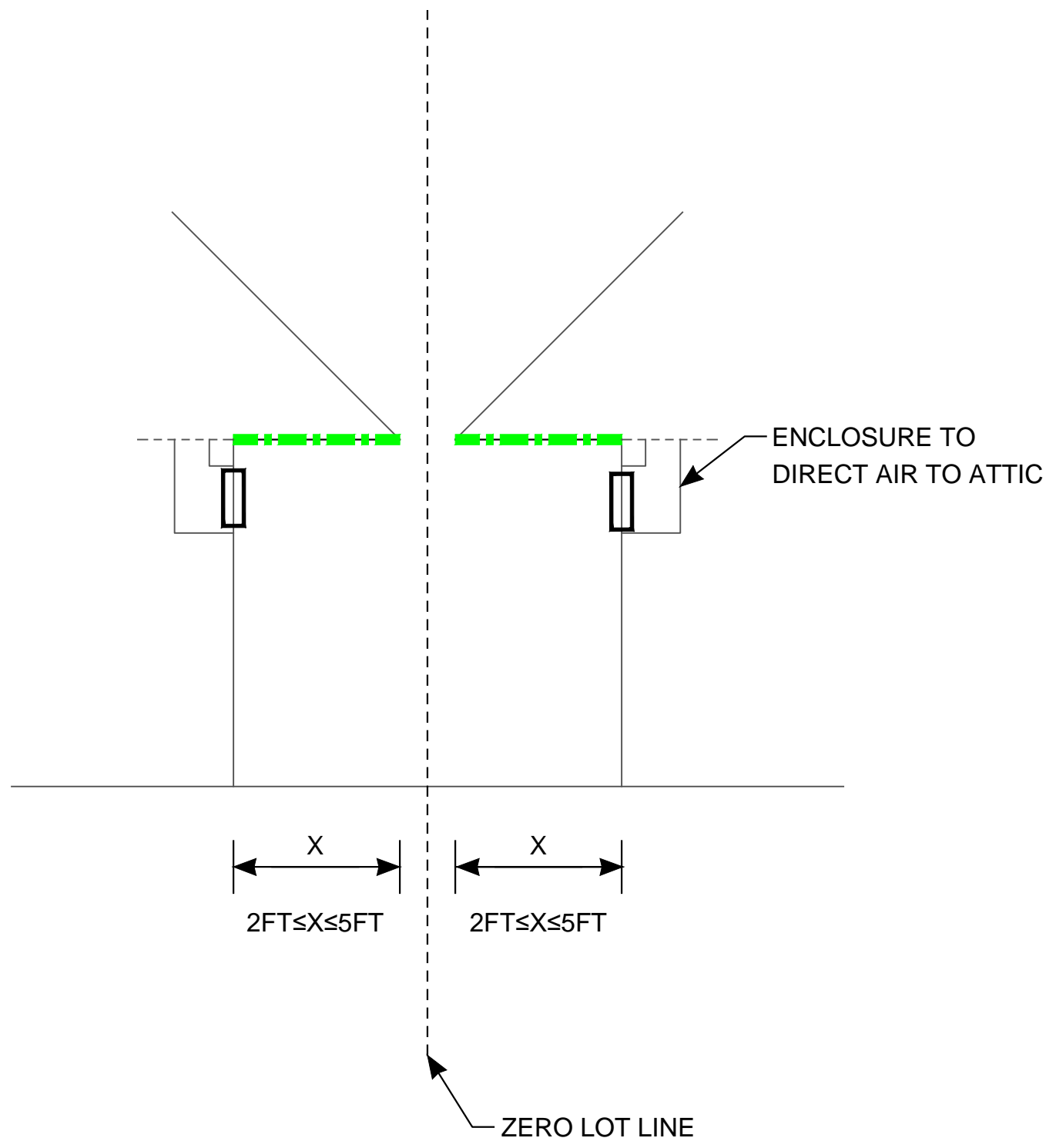

DETACHED - OPTION 2
 NOT TO SCALE

ENGINEER'S SEAL

INTERNATIONAL
 RESIDENTIAL CODE
 CHANGES

PROJECT TITLE

CONSULTANT

MAY 20, 2016	U013-03
SUBMITTAL DATE	KA PROJECT NO
AS NOTED	FULL SIZE
DRAWING SCALE	PLOT SCALE
K. CUSTODIO	K. STERANKA
DRAWN BY	DESIGNED BY
C. AYLER	C. AYLER
REVIEWED BY	APPROVED BY

DETACHED
 ZERO-LOT LINE
 OPTIONS

SHEET TITLE

FS.01.2

DRAWING NUMBER

GENERAL NOTES:

1. REFER TO APPENDIX C OF REPORT FOR ADDITIONAL FIRE PILLOW INFORMATION.

2. THE NUMBER OF FIRE PILLOWS REQUIRED IS DEPENDENT ON THE WIDTH OF THE EAVE.

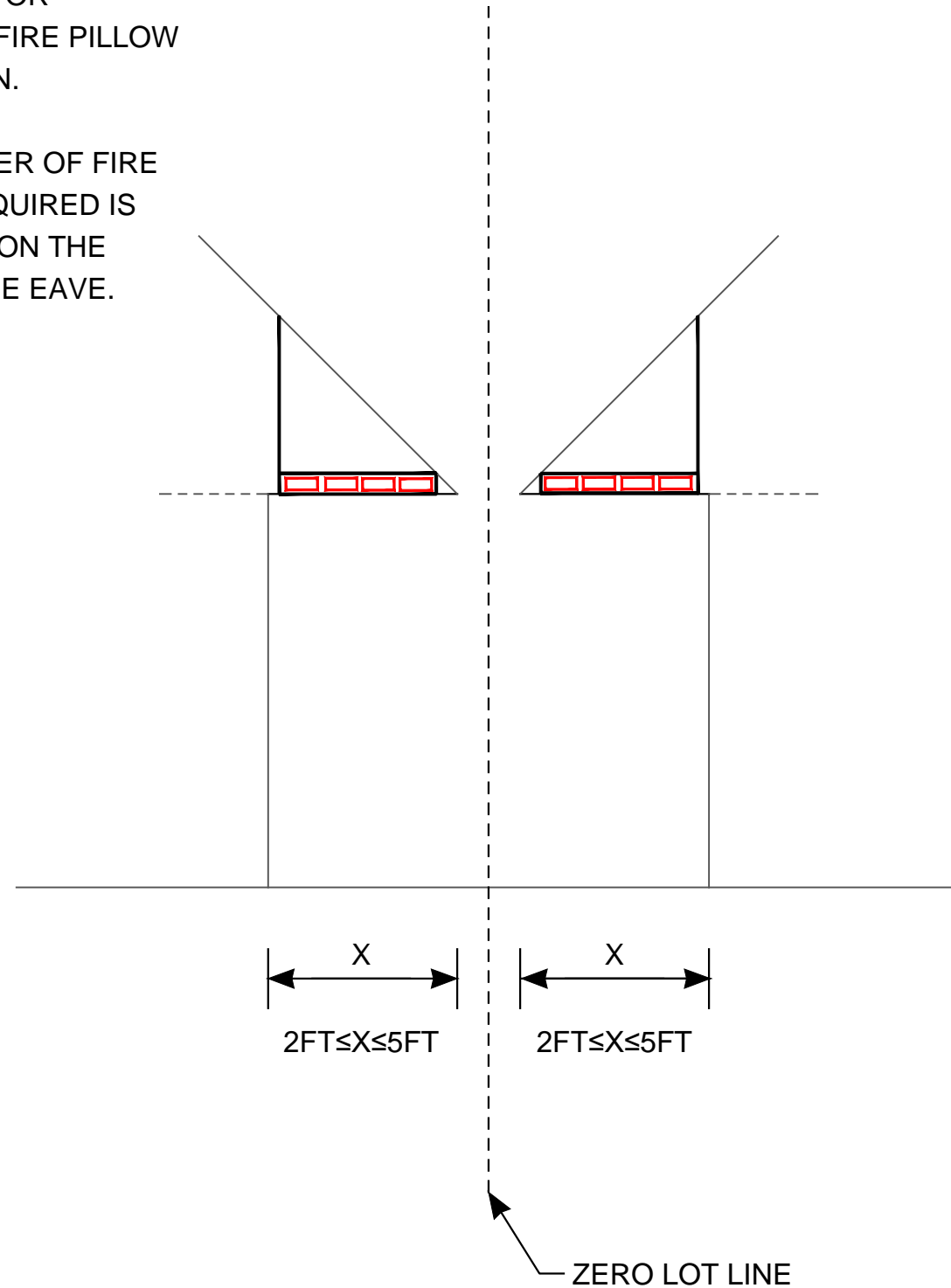

DETACHED - OPTION 3
NOT TO SCALE

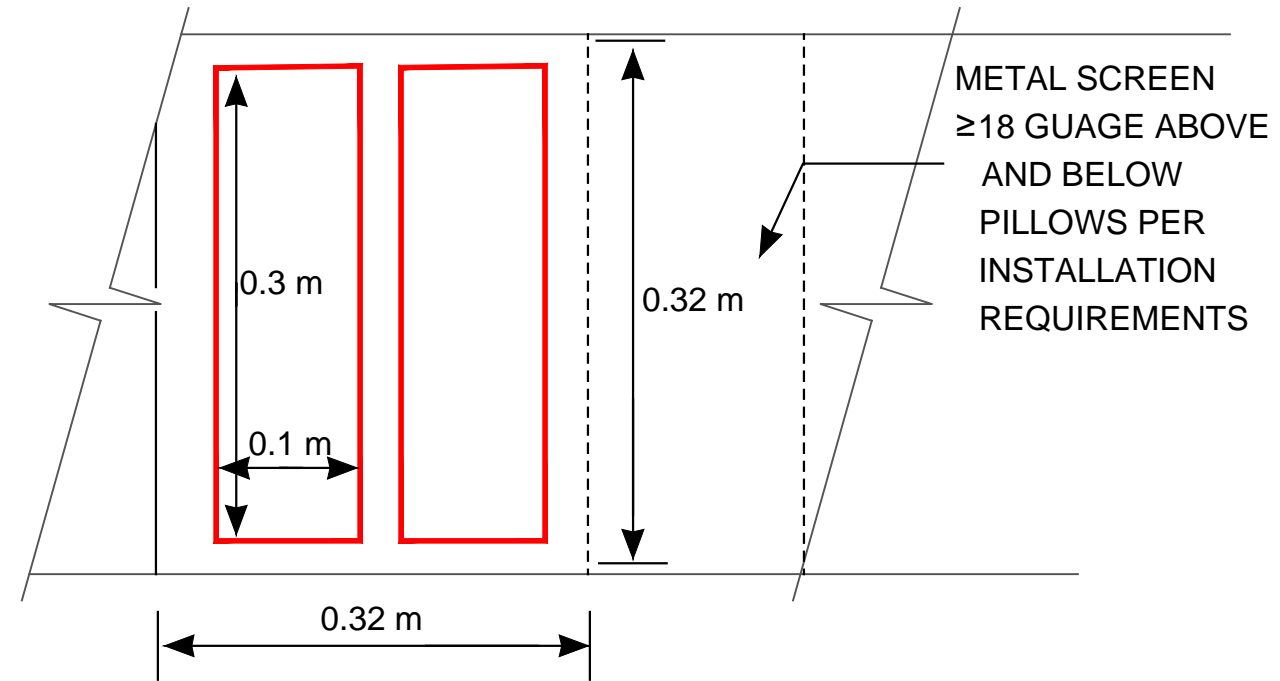

PLAN VIEW OF PILLOW MATRIX
NOT TO SCALE

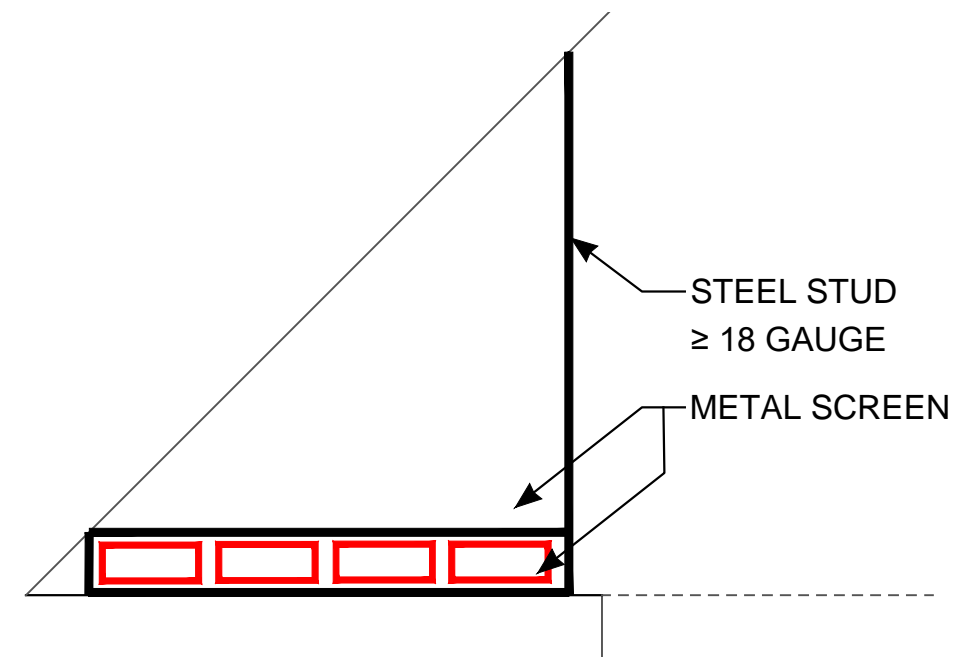

PLAN VIEW OF PILLOW MATRIX
NOT TO SCALE

REVISIONS		
NO	DATE	DESCRIPTION
1	5-09-16	EAVE PROTECTION

LEGEND	
	1 HR FIRE SEPARATION
	1 HR DAMPER
	FIRE BLOCKING
	FIRE PILLOW

ENGINEER'S SEAL

INTERNATIONAL RESIDENTIAL CODE CHANGES
PROJECT TITLE

CONSULTANT

MAY 20, 2016	U013-03
SUBMITTAL DATE	KA PROJECT NO
AS NOTED	FULL SIZE
DRAWING SCALE	PLOT SCALE
K. CUSTODIO	K. STERANKA
DRAWN BY	DESIGNED BY
C. AYLER	C. AYLER
REVIEWED BY	APPROVED BY

DETACHED ZERO-LOT LINE OPTIONS
SHEET TITLE

FS.01.3
DRAWING NUMBER

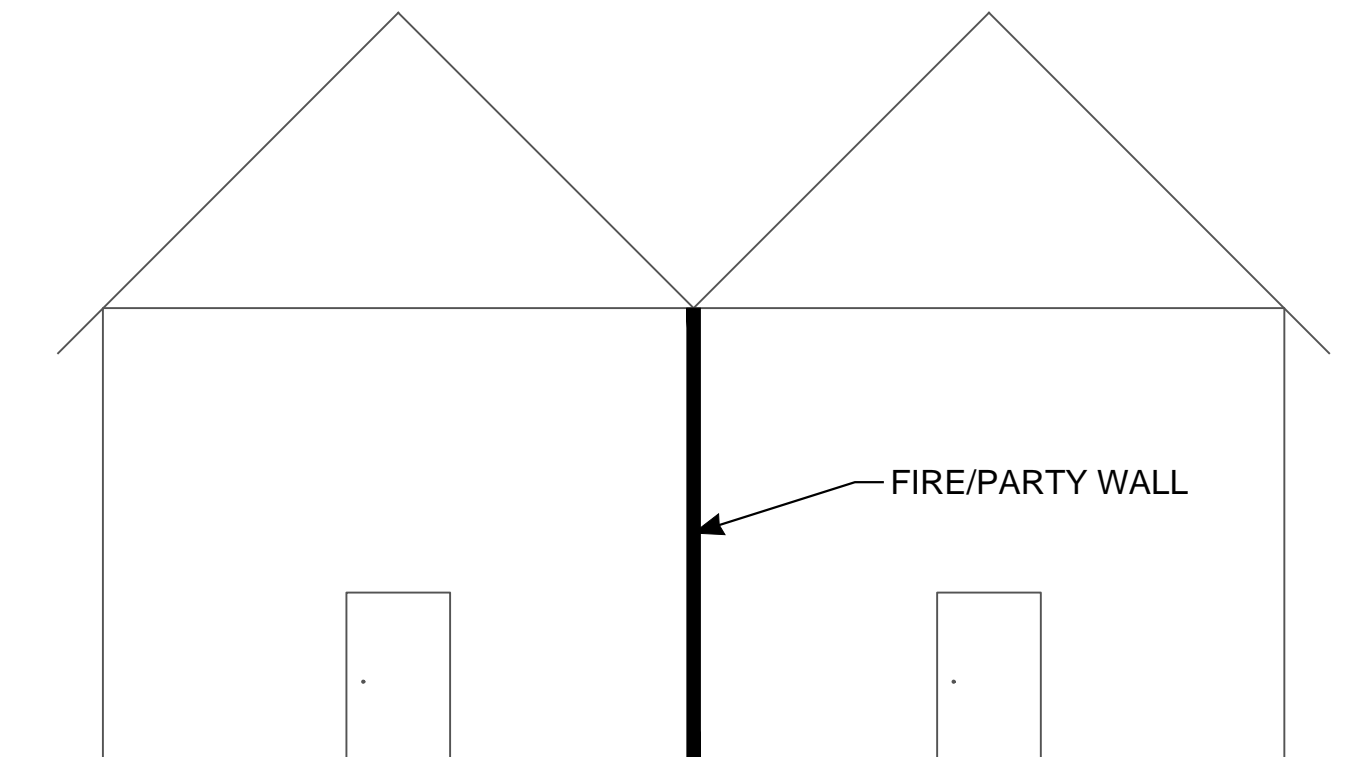

ELEVATION VIEW

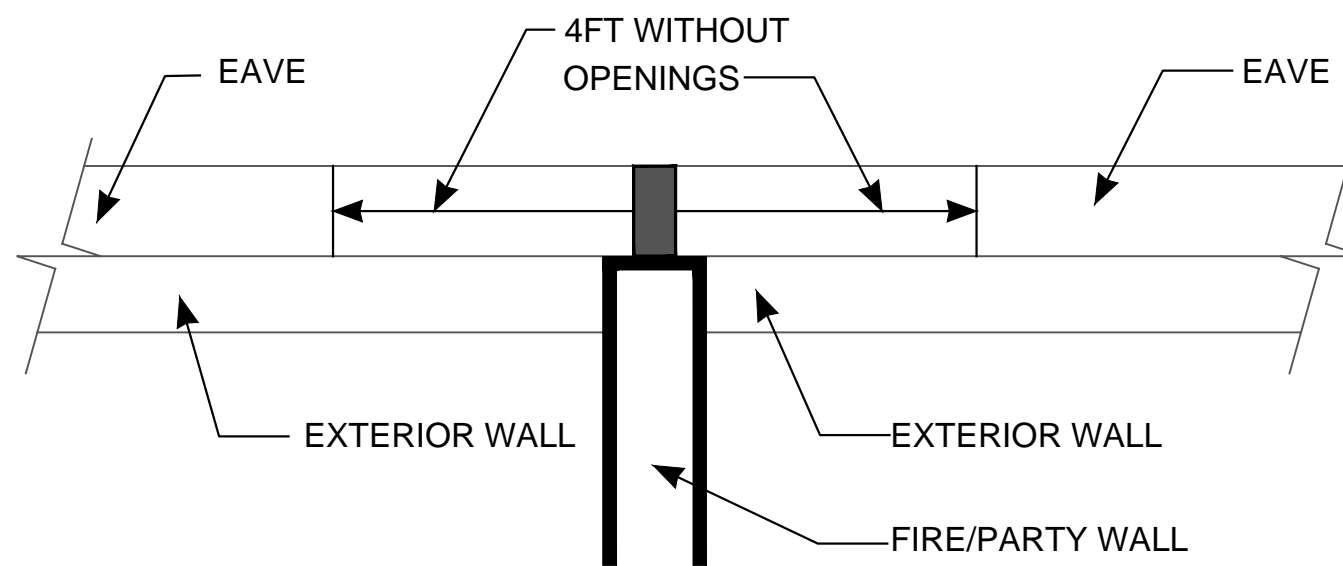

PLAN VIEW - EXTERIOR WALL

ATTACHED - OPTION 1: IN-LINE EXTERIOR WALLS

NOT TO SCALE

REVISIONS		
NO	DATE	DESCRIPTION
1	5-09-16	EAVE PROTECTION

LEGEND	
	1 HR FIRE SEPARATION
	1 HR DAMPER
	FIRE BLOCKING
	FIRE PILLOW

ENGINEER'S SEAL

INTERNATIONAL RESIDENTIAL CODE CHANGES

PROJECT TITLE

CONSULTANT

MAY 20, 2016	U013-03
SUBMITTAL DATE	KA PROJECT NO
AS NOTED	FULL SIZE
DRAWING SCALE	PLOT SCALE
K. CUSTODIO	K. STERANKA
DRAWN BY	DESIGNED BY
C. AYLER	C. AYLER
REVIEWED BY	APPROVED BY

DETACHED ZERO-LOT LINE OPTIONS

SHEET TITLE

FS.01.4

DRAWING NUMBER

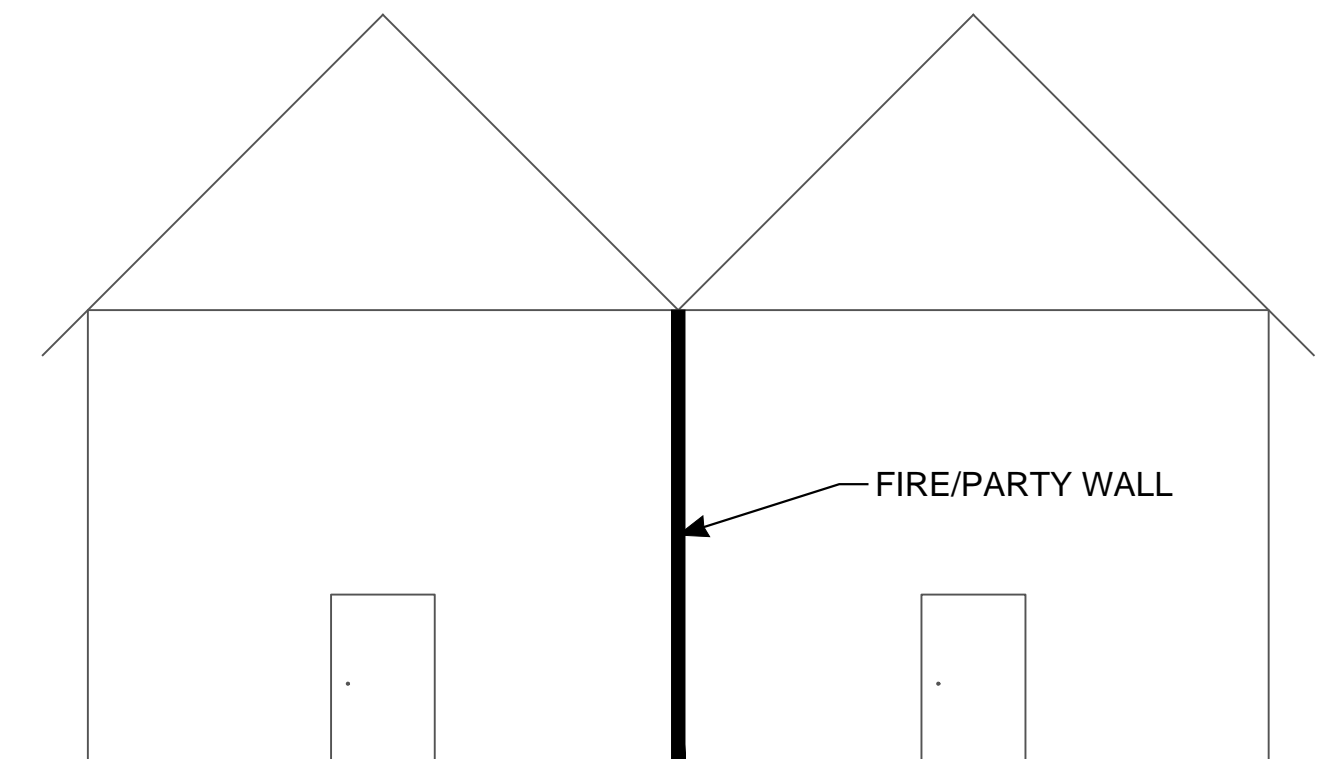

ELEVATION VIEW

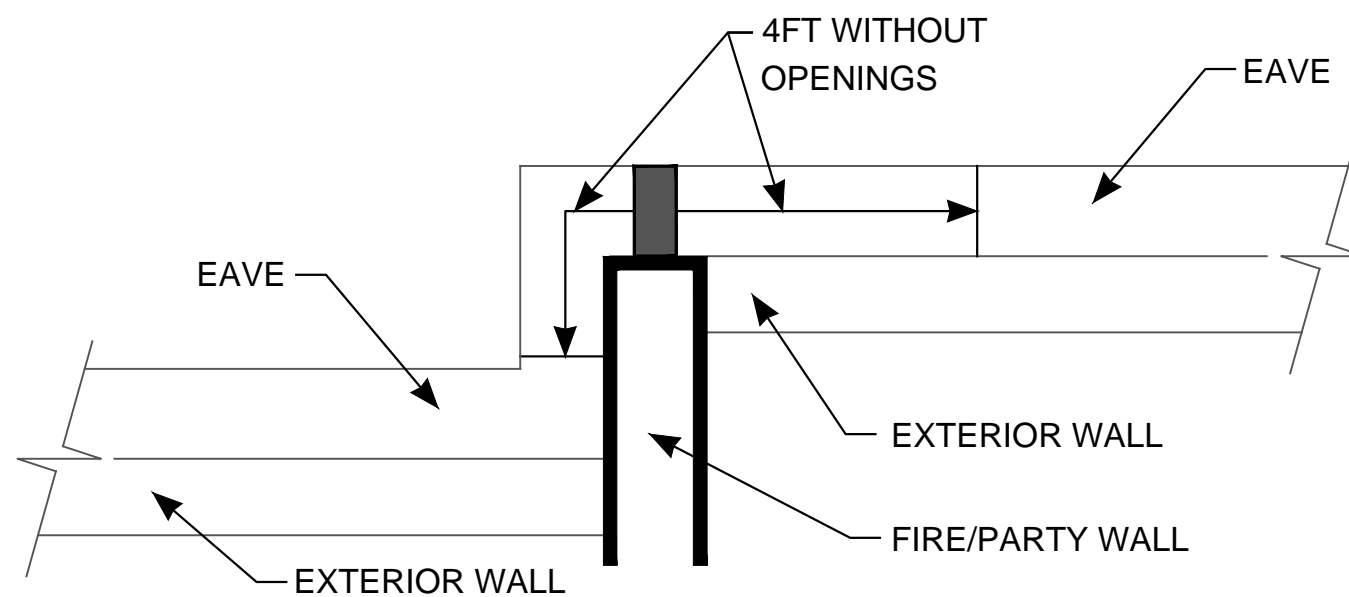

PLAN VIEW - EXTERIOR WALL

ATTACHED - OPTION 2: OFF-SET EXTERIOR WALLS

NOT TO SCALE

REVISIONS		
NO	DATE	DESCRIPTION
1	5-09-16	EAVE PROTECTION

LEGEND	
	1 HR FIRE SEPARATION
	1 HR DAMPER
	FIRE BLOCKING
	FIRE PILLOW

ENGINEER'S SEAL

INTERNATIONAL RESIDENTIAL CODE CHANGES

CONSULTANT

MAY 20, 2016	U013-03
SUBMITTAL DATE	KA PROJECT NO
AS NOTED	FULL SIZE
DRAWING SCALE	PLOT SCALE
K. CUSTODIO	K. STERANKA
DRAWN BY	DESIGNED BY
C. AYLER	C. AYLER
REVIEWED BY	APPROVED BY

DETACHED ZERO-LOT LINE OPTIONS

FS.01.5

DRAWING NUMBER

APPENDIX C

FIRE PILLOW DATA SHEET



FIRE STOP PILLOWS

Quelfire Fire Stop Pillows provide both temporary and permanent fire stop seals through penetrations in walls and floors. They can be used as temporary measure for buildings under construction and as a permanent solution following the completion of the project in those areas where the need for access or alteration is anticipated. They are suitable for any type of building in which a fire compartment or separating wall or floor is penetrated by cables or non-combustible pipes. Quelfire Fire Stop Pillows are particularly useful prior to commissioning main services and during the installation of communication facilities which are subject to constant modification.

Regulations

The UK Building Regulations requires services penetrating fire compartments and separating walls and floors to be fire stopped. Quelfire Fire Stop Pillows have been tested in accordance with BS 476: Part 20 by Warrington Fire Research Centre (ref. WARRES 50518). The test demonstrated the ability of the pillows to maintain their integrity and insulation performance for up to 4 hours.

Description

Quelfire Fire Stop Pillows consist of a homogeneous mixture of granulated graphite and vermiculite with fire protection additive chemicals contained within a sealed polyethylene sack. The sack is protected by finely woven fibre glass cover specially treated with a silicone film that provides an exceptionally high tensile strength. This strength is maintained by sewing the seams with non-corrosive cotton coated wire. Quelfire Fire Stop Pillows are totally sealed and are suitable for use in clean room installations. They can also be used safely for covering communication data cable in computer rooms or telephone exchanges.

Performance

Fire

When Quelfire Fire Stop Pillows are subjected to heat the intumescent content reacts and expands to form a rigid, gas and flame tight seal, which provides protection for up to 4 hours. The smallest apertures between pipes, cables, conduits, other services and the surrounding building fabric are completely sealed by the expanding contents.

Liquid

Fire Stop Pillows are resistant to the penetration of driven or standing water and humidity. Where pillows are used in a penetration requiring waterproofing, other forms of sealing will need to be introduced to prevent the passage of water through the joints.

Biological

Fire Stop Pillows are not susceptible to insect or rodent attack and are unaffected by fungi, moss, lichen, mould, bacteria and general industrial atmospheres.

Thermal

Fire Stop Pillows are not affected by variations in temperatures, heat, cold or conditions of frost.

Optical

Fire Stop Pillows are resistant to attack from UV light.

Durability

Quelfire Fire Stop Pillows are fabricated from extremely hardwearing materials and can be used as a permanent installation without deterioration or loss of performance.

Compatibility

The sealed condition of each pillow provides permanent protection to the contents and they can be used safely under normal building conditions.

STANDARD SPECIFICATION CLAUSE
'Install Quelfire MW Slabs for use as shuttering where services are protected by Quelfire QF2 Fire Protection Compound. MW Slab should be cut to size and friction fitted prior to installation of QF2. All in accordance with manufacturer's instructions.'

Full specifications for individual projects can be supplied by Quelfire on request

Size

Area m2	Product type	20%	Cable Area 40%	60%
0.10	PS300	2	2	1
0.10	PS750	11	9	6
0.50	PS300	10	10	5
0.50	PS750	55	45	30
1.00	PS300	10	50	1
1.00	PS750	110	90	60

Product Type	L	W	D
PS150	300	50	35
PS300	300	100	35
PS750	300	200	35

Please Note: Quantities shown are the total requirements of BOTH PS 300 and PS 750 pillows.
PS 300 size = 300mm x 100mm (compressed)
PS 750 size = 300mm x 100mm (compressed)

Application

Quelfire Fire Stop Pillows are suitable for all types of new and refurbished building projects and most appropriate for use during the construction of offices, hospitals, hotel and conference centres, etc. They are designed to maintain fire compartmentation in buildings and protect equipment during the installation period. Fire Stop Pillows will provide a temporary seal for any through penetration during the construction phase. On completion of the service installation, the Quelfire Fire Stop Pillows can be removed where required and the openings fire stopped with QF2 Fire Protection Compound or the Quelfire SS System, as a permanent solution. Quelfire Fire Stop Pillows are particularly useful during the installation of communication and data cables which are subject to alteration during construction.

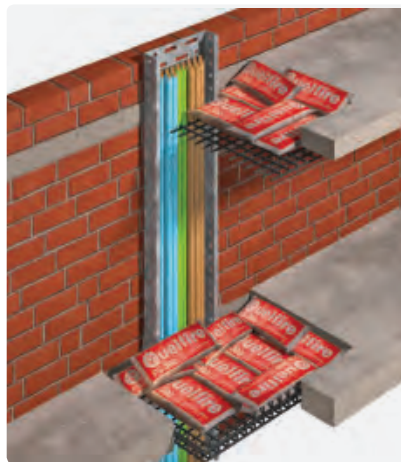

Wall penetration by electric cables carried on a suspended cable tray. It is recommended that one layer of pillows is placed between the cables and the tray to ensure maximum protection. Pillows should be inserted in wall penetrations with the length of the pillow at right angles to the wall.

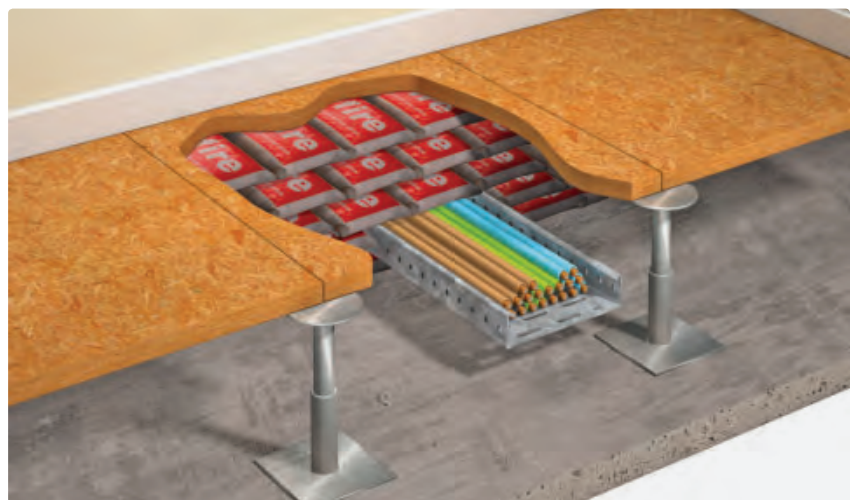

Floor and ceiling penetration incorporating a wire tray fitted from below with wire cover fitted from above. Where access is unavailable from below, a wire supporting basket can be suspended as illustrated with an optional security cover.

Installation

Quelfire Fire Stop Pillows are placed in position by hand one layer at a time. Joints should be staggered between each layer and overlap a minimum of 25mm.

Wall Penetration

Before inserting the Quelfire Fire Stop Pillows into the opening, place each one onto a flat surface and compress by hand until the contents are evenly distributed. When installing they should be packed tightly into the opening, and positioned horizontally or vertically with the joints staggered.

It may be advantageous to use pillows of different size to achieve a tight seal. For small spaces fold or roll a pillow lengthwise before inserting. Where a cable tray is used it is recommended that one layer of pillows is placed beneath the cables to achieve a tight fit with the pillows above the cables. Occasionally, where it is difficult to insert the last layer of pillows at the top of a penetration, the problem can be solved by first placing the pillows between two thin strips of metal or plastic. The package is then pushed into the opening and the strips finally removed.

Floor & Ceiling Penetration

To install Quelfire Fire Stop Pillows in a floor or ceiling opening it is necessary to use a restraining wire tray. These can be fitted either from above using a basket type construction or from below using a flat tray. A corresponding cover flat wire tray is fitted over the top to protect the pillows from unauthorised removal or damage. The trays should overlap the penetration opening by a minimum of 150mm on all sides and be secured by steel expansion bolts and washers. Pillows should be positioned within the tray in two layers with the second layer overlapping the first layer on all edges. Additionally where required, pillows can also be positioned upright around the cables.

Handling & Storage

Quelfire Fire Stop Pillows should be stored in clean, dry conditions.

Maintenance

Once installed correctly Quelfire Fire Stop Pillows require no further maintenance. They can be removed and re-used as required and if handled correctly will last for the life of the building without loss of performance.

Prices & Conditions of Sale

Prices

Current prices for Quelfire Fire Stop Pillows will be quoted on application.

Conditions of Sale

Due to a policy of continuing development, products may differ from those described in this leaflet and the descriptions contained here do not form part of any contract. Specific details are to be agreed at the time of placing an order and products are offered subject to the company's Conditions of Sale which are available on request from Quelfire.

Availability

Quelfire Fire Stop Pillows can be obtained from Quelfire. Delivery is normally from stock.

Ordering

All orders are to be directed to Quelfire.
Tel: +44 [0] 161 928 7308
Email: sales@quelfire.co.uk

Packaging

Goods for each order are packed in cardboard boxes and normally delivered by express road courier service. Alternatively goods can be collected personally from Quelfire, Altrincham, Cheshire during normal business hours.

References

Please refer to Quelfire for further information on Fire Stop Pillows and other specialist fire protection products for all building applications

Technical Services

Quelfire are leading specialists in the supply of fire protection products for buildings and are available to advise on specific applications and uses for their products. The company is pleased to carry out site visits and surveys where required. Test data, technical information and samples of products are available upon request.

Quelfire maintain a policy of constant improvement and reserve the right to alter or amend the specifications of their products without notice. Quelfire & Quelfire are Registered Trademarks.

WARRANTY

The Company warrants its products to be free from defects in material and workmanship for a period of 12 months from the date of delivery. The Company's obligation under this warranty is limited, as its option, to the repair or replacement, free of charge, or refund of the net Invoiced price of any part found to be defective, and which, in the Company's opinion, has not been subject to undue wear and tear, accident, alteration, abuse or misuse. Consequent damages are expressly disclaimed. Technical advice from Quelfire whether verbal, in writing or by way of trials, is given in good faith but without warranty. The application, use and installation of the Company's products are beyond the control of the Company, and the purchaser is solely responsible that goods are fit for any particular purpose. In line with the Company's policy of continual research and development, product specifications and availability are subject to change or withdrawal without prior notice.

DIMENSIONS

In line with general practice all dimensions shown are nominal